

Emergency Stop for NX Safety

Ei JW`GHfhGuide

This guide describes how to program an emergency stop using Sysmac Studio software.

Overview

Items needed: Sysmac Studio, version 1.07 or higher.

Quick Summary

- 1.) Node setting – See chart under “Node Set-up”.
- 2.) Set up each mode’s variable name in the I/O map.
- 3.) Function block - SF_EmergencyStop, entering variable names as inputs

Description

For the purposes of this document, a dual channel emergency stop pushbutton will be used.

Additional Information

www.omron247.com.

[Z931 manual](#) – NX-series Safety Control Unit

Function block details

[Z930 manual](#) - Safety Control Unit

Application examples in appendix

[Devices](#) - Emergency stop options



Node Set-up

Sysmac Studio steps: **Multiview explorer** -> Select Safety CPU -> Configuration and setup -> Communications -> Safety -> Safety I/O -> Select a node -> double click on parameters -> click on the white X next to the filter to see all of the nodes -> use **toolbox** to select a safety device (might need to drag right side window to see the toolbox) -> drag and drop parameter to knob -> complete for all nodes. **Note: The fields in the nodes are not used in the program. Could be used to enter part name/type/number.**

Use the chart to determine your input device configuration.

A22E-_-01	Mechanical contact for single channel
A22E-_-11	Mechanical contact for single channel
A22E-_-02	Mechanical contact for dual channel equivalent
A22E-_-12	Mechanical contact for dual channel complementary
A22E-_-03	Mechanical contact for dual channel equivalent
A165E-_-01	Mechanical contact for single channel
A165E-_-02	Mechanical contact for dual channel equivalent
A165E-_-03U	Mechanical contact for dual channel equivalent

Equivalent or Complimentary?

If the contacts open and close at the same time, they are equivalent.

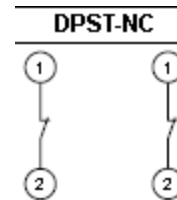

If the contacts open and close in opposite direction, they are complementary.

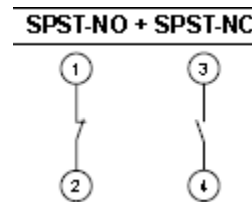

Keep the default test pulses.

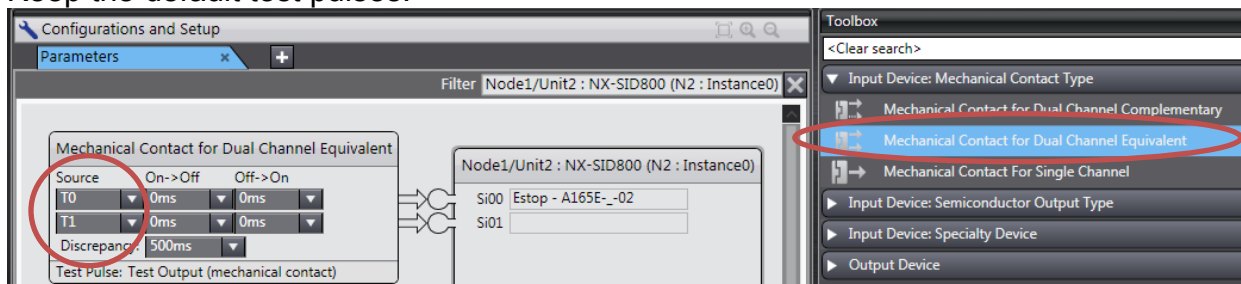

I/O Map

Systemc Studio steps: **Multiview Explorer** -> select Safety CPU -> Configurations and Setup -> double click on I/O Map -> make sure arrow buttons are all pointing down -> use variable template to paste (**Note: It will not paste if there is an empty field. Can only do groups when no empty fields.**) **OR** manually enter with right click **OR** scroll down to highlight all variables -> right click -> select variable. (**Note: Do not enter a variable name for the second input or output of dual channel devices.**)

Enter the input variable name into the I/O map. Do not enter a name for the second channel of a dual channel device.

Position	Port	R/W	Data Type	Variable
EtherCAT Network				
EtherCAT Master	Master			
Node1/Unit2				
NX-SID800				
Safety Inputs				
	Si00 Logical Value	R	SAFEBO	Emergency_Stop
	Si01 Logical Value	R	SAFEBO	
	Si02 Logical Value	R	SAFEBO	KM1
	Si03 Logical Value	R	SAFEBO	KM2
	Si04 Logical Value	R	SAFEBO	Reset_PB
	Si05 Logical Value	R	SAFEBO	
	Si06 Logical Value	R	SAFEBO	
	Si07 Logical Value	R	SAFEBO	
Status				
	Safety Connection Status	R	SAFEBO	N2_Safety_Connection_
	Safety Input Terminal Status	R	SAFEBO	N2_Safety_Input_Termin

SF_EmergencyStop Function Block Inputs

Systemc Studio steps: **Multiview Explorer** -> select new_safetyCPU -> Programming -> POU -> Programs -> Program0

Toolbox -> Safety Function Blocks -> left click on a function block and drag onto the white part of the screen until you see a box that says "start here" and it turns green

Click on white space next to the inputs (**always on left side of the FB**) -> click on the box with the three dots -> make sure "global variables" is selected under "categories", then select the input from the list **OR** start to type and select input from pulldown list. **Inputs highlighted in yellow and start with S_ require a SAFE variable type.**

Enter the input.

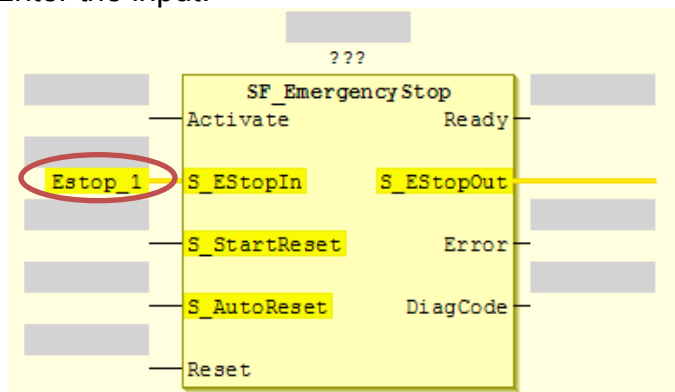

SF_EmergencyStop Function Block Outputs

System Studio steps: Click on white space next to the outputs (**always on right side of the FB**) -> click on the box with the three dots -> make sure "global variables" is selected under "categories", then select the input from the list. **Outputs highlighted in yellow and start with S_ require a SAFE variable type.**

Enter the output.

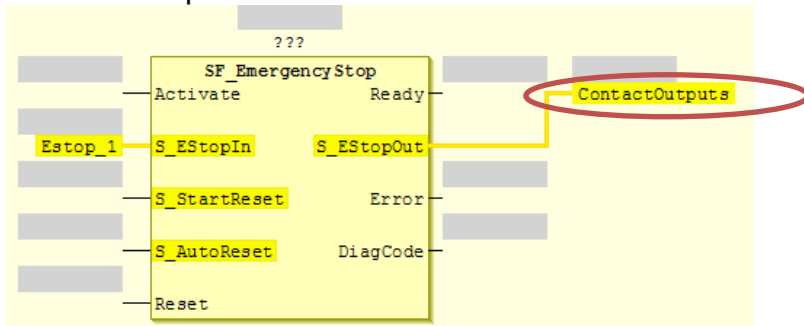

Other Input and Output options

S_StartReset Input

Does a reset button need to be pressed at start-up?

If yes, leave blank (since FALSE is default)

If no, enter "True".

S_AutoReset Input

Does a reset button need to be pressed after the emergency start button is activated?

If yes, leave blank (since FALSE is default)

If no, enter "True".

Reset

Enter the variable name for the reset button. (Note: Reset is a reserved variable so either pick a new different name or add an extension.)

Enter TRUE if no reset button is being used.

Name

Give the function block a unique name.

Reduce function block size

Right click the mouse inside the function block -> Remove unused FB call parameters

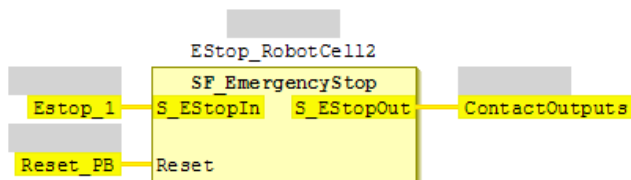

Wiring

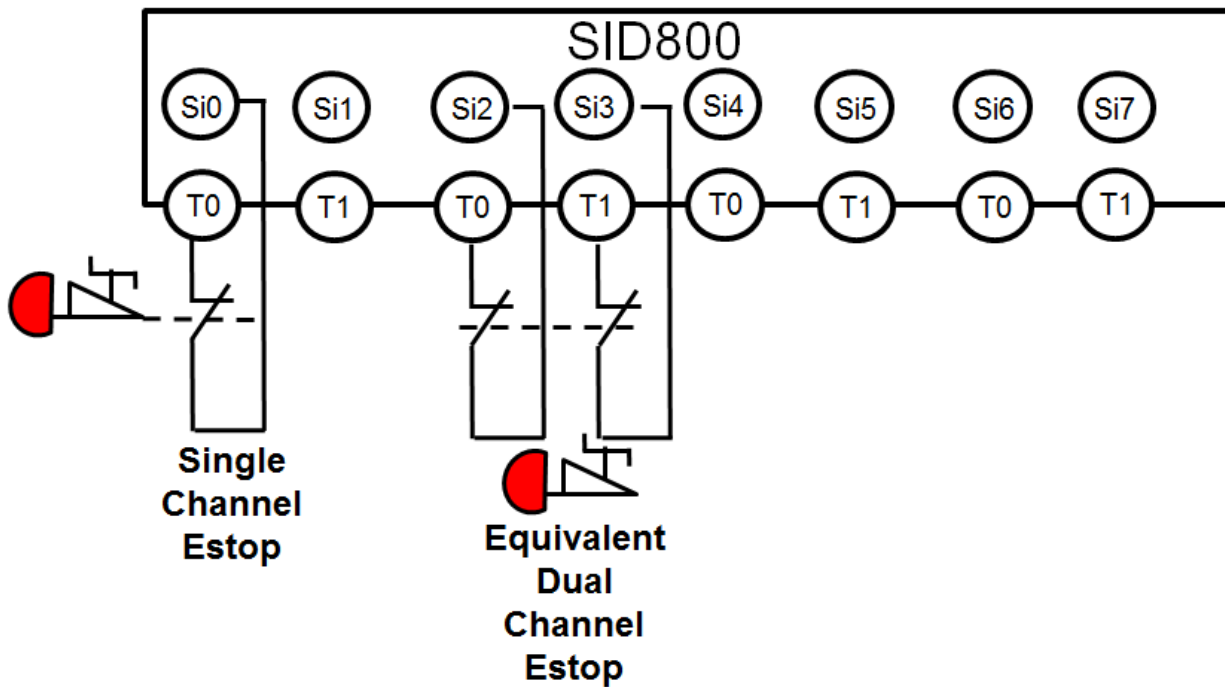

Notes on dual channel devices:

- 1.) first input starts with T0
- 2.) consecutive order (i.e., Si4 and Si5)
- 3.) wired into the same module **

** If wired into different input modules, the timing of the test pulse signals may be out of sync and cause false shut-downs.

Standards

Did you Know?

Emergency stop devices are NOT considered safeguarding devices?

ANSI B11.19-2010, clause 12.9 – they are complementary to the guards, safeguarding devices, awareness barriers, signals and signs, safeguarding methods and procedures.

Why? Safeguarding devices detect and prevent inadvertent access to the hazard. A person may not even be aware of it. Emergency stops require a deliberate action by the individual to stop the motion.

NFPA 79

Electric contacts must have a direct opening mechanism.

Emergency stop devices must have a holding function that will mechanically hold in the stop position until the device is manually reset.

Actuators of an emergency stop device must be colored red and of a mushroom shape. The background immediately behind the actuator must be colored yellow.

Consideration must be given to the following items when a wire is used as an actuator.

- (1) The amount of deflection needed to generate the emergency stop signal.
- (2) The maximum deflection possible.
- (3) The minimum clearance between the wire and the nearest machine in the vicinity.
- (4) The amount of force required for operation.
- (5) The ease with which an operator can locate the device, by use of a marker flag or other method.
- (6) The automatic generation of an emergency stop signal in the event that the wire breaks or becomes detached

Other Standards

ISO 13850

IEC 60204-1