

## Very stylish, very industrial

Our new industrial-quality touchscreen monitors are good-looking but more importantly they also enable the operator and the maintenance engineer to interact with the machine more effectively. Our smart algorithms mean the touchscreen controller can detect non-standard actions such as false touches, palm rejection, water and cleaning - even if the user is wearing gloves. Very stylish, very industrial.



## Features

- 12.1, 15.4 and 18.5 inch industrial display
- Multitouch projected capacitive touchscreen
- Winner iF award for excellent industrial design \*1
- False touch detection (palm, water)
- Operator can wear gloves \*2
- Backlight control
- Two USB-A, one USB-B (from host), one DVI
- Optional NY Monitor Link interface for connectivity up to 100 m
- Standard and 100 m cable models are available.
- Easy mounting



\*1. The iF Product design Award, presented by Hannover-based International Forum Design GmbH, is one of the world's most prestigious design awards. Products are rated on uniqueness, innovation, aesthetic appearance, usefulness and eco-friendliness as well as performance, quality and price.

\*2. When using gloves, ensure to use gloves that are functional with this touchscreen.

# System Configuration

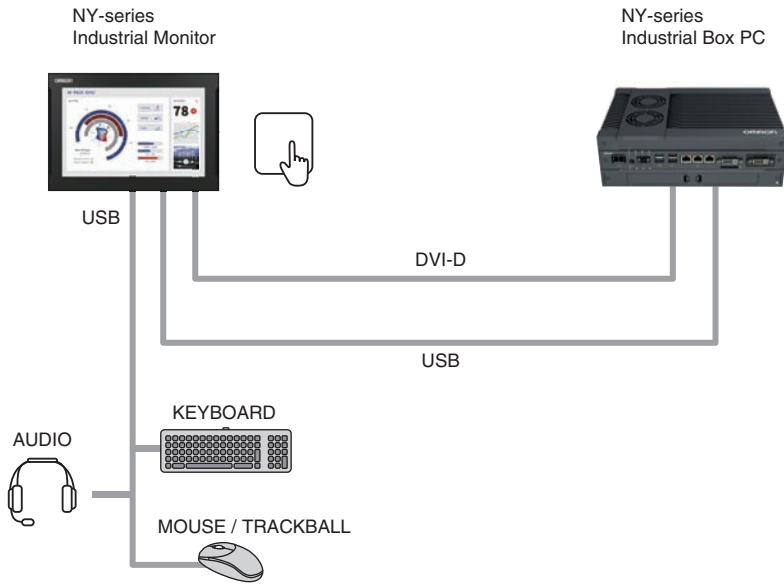
## With a DVI-D interface



-  Industrial Monitor Utility  
- User interface to control settings and display details of connected Industrial Monitors
-  Industrial Monitor Brightness Utility  
- Allows to control brightness of screen backlight and LEDs of all connected Industrial Monitors
-  Industrial PC Tray Utility  
- Informs you about the current state of the Industrial Monitor, its related devices and associated software.

## With an NY Monitor Link interface

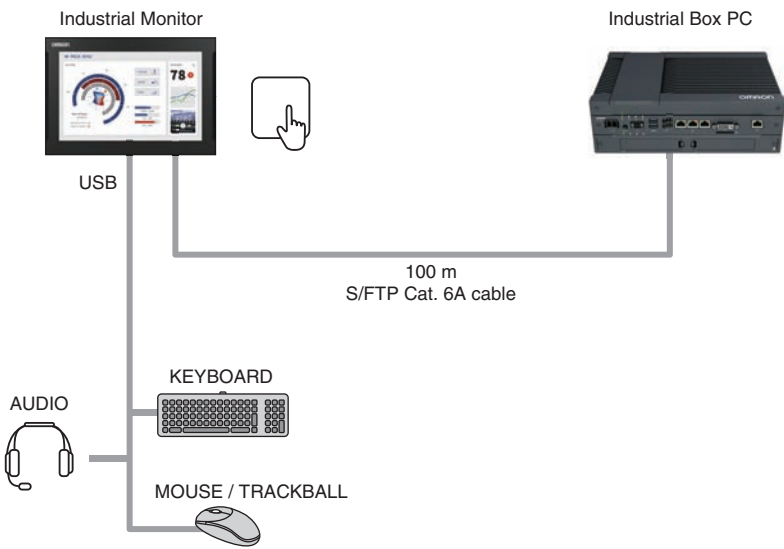

# Model Number Structure

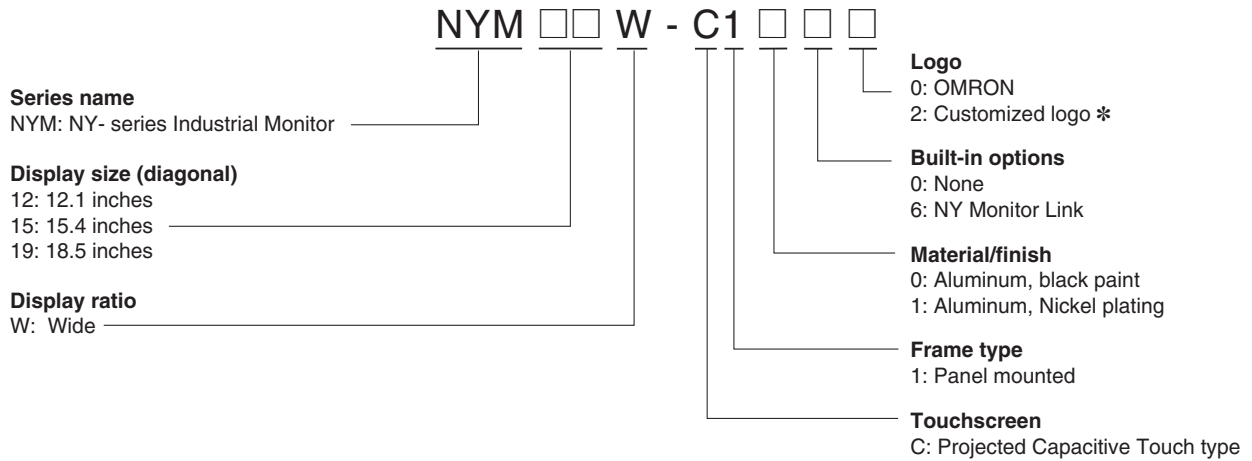

\* Please consult your OMRON representative for details.

## Ordering Information

### NY-series Industrial PC Platform

Product name	Specifications	Specifications		Model
		Interface	Display size	
Industrial Monitor	An industrial monitor with a touchscreen as the user interface designed to work in industrial environments	DVI-D	12.1 inches	NYM12W-C1000
			15.4 inches	NYM15W-C1000
			18.5 inches	NYM19W-C1000 *
		NY Monitor Link	12.1 inches	NYM12W-C1060
			15.4 inches	NYM15W-C1060
			18.5 inches	NYM19W-C1060 *

\* 18.5 inch models also available with Nickel Plating front.

### Optional Hardware

Product Item	Specifications	Model
Power Supply	<ul style="list-style-type: none"> <li>Output voltage: 24 VDC</li> <li>Push-In Plus terminal blocks</li> </ul>	S8VK-S□□□24
USB Type-A to USB Type-B Cables	Cable length: 2 m USB 2.0 Minimum bend radius: 25 mm	FH-VUAB 2M
	Cable length: 5 m USB 2.0 Minimum bend radius: 25 mm	FH-VUAB 5M
DVI Cables	Cable length: 2 m Supports DVI-D Minimum bend radius: 36 mm	NY000-AC00 2M
	Cable length: 5 m Supports DVI-D Minimum bend radius: 36 mm	NY000-AC00 5M

### Software

Item	Descriptions
Industrial Monitor Utility	The Industrial Monitor Utility provides a user interface to control settings and display details of connected Industrial Monitors. It is pre-installed on the Industrial Box PC and the Industrial Panel PC.
Industrial Monitor Brightness Utility	The Industrial Monitor Brightness Utility is a small software utility that allows you to control the brightness of the screen backlight of all connected Industrial Monitors. It is pre-installed on the Industrial Box PC and the Industrial Panel PC.
Industrial PC Tray Utility	The Industrial PC Tray Utility is a software utility that provides information about the current state of the Industrial PC, its related devices, and associated software. It is pre-installed on an Industrial Box PC and the Industrial Panel PC.
Industrial Monitor API	The Industrial Monitor API allows programmers to create applications that can control the hardware features and retrieve information from connected Industrial Monitors. It is pre-installed on the Industrial Panel PC and Industrial Box PC. Install the Industrial Monitor SDK to use the Industrial Monitor API on development PCs.

## Specifications

### Performance Specifications

#### Display Specifications

Item		Specifications		
		12.1 Inch models	15.4 Inch models	18.5 Inch models
Display panel *1	Display device	TFT LCD		
	Screen size	12.1 inches	15.4 inches	18.5 inches
	Surface treatment	Anti glare treatment		
	Surface hardness	Mohs scale: 5 - 6		
	Resolution	1,280 × 800 pixels at 60 Hz (horizontal × vertical)		1,920 × 1,080 pixels at 60 Hz (horizontal × vertical)
	Colors	16,770,000 colors		
	Effective display area	261 × 163 mm (horizontal × vertical)	331 × 207 mm (horizontal × vertical)	409 × 230 mm (horizontal × vertical)
	View angles	Left: 60°, Right: 60°, Top: 60°, Bottom: 60°		Left: 89°, Right: 89°, Top: 89°, Bottom: 89°
	Life	50,000 hours min. *2		
Brightness adjustment *3	200 levels			
Touch	Technology	Projected capacitive		
	Touch resolution	Touch accuracy 1.5% (4-5 mm)		
	Multitouch	Up to 5 simultaneous touches		
	Features	Water detection *4, hand palm rejection *5, gloves *6		
	Life	50,000,000 operations min.		
EMC	Correct touchscreen operation is possible within allowable EMC immunity conditions			

\*1. There may be some defective pixels in the display. This is not a fault as long as the numbers of defective light and dark pixels fall within the following standard range: light and dark pixels 10 or less. (There must not be 3 adjacent light/dark pixels.)

\*2. This is the estimated time before brightness is reduced by half at room temperature and humidity.  
The life expectancy is drastically shortened if used at high temperatures.

\*3. If the brightness is set to very dark, it causes flickering or the screen will be too dark to use.

\*4. If water is detected the touch functionality will not be available.

\*5. If a palm is detected that specific area is neglected.

\*6. The touchscreen can be operated when wearing gloves. Confirm the touchscreen can be operated with gloves before actual operation.

#### Connector Specifications

Item		Industrial Monitor				
		NYM12W-C100□	NYM15W-C100□	NYM19W-C1□0□	NYM12W-C106□	NYM15W-C106□
Power connector		24 VDC				
USB2.0 Type-A	Number of ports	2				
	Maximum current	500 mA max.				
	Maximum cable length	5 m				
USB2.0 Type-B	Number of ports	1		-		
	Maximum cable length	5 m		-		
DVI-D connector	Video interface	Digital only				
	Resolution	1,280 x 800 pixels at 60 Hz	1,920 x 1,080 pixels at 60 Hz	-		1,920 x 1,080 pixels at 60 Hz
	Maximum DVI cable length	5 m				
NY Monitor Link	Video interface	-		Digital only		
	Resolution	-		1,280 x 800 pixels at 60 Hz		
	Connector type	-		RJ45		
	Cable shielding, type and max. length	-		S/FTP, Cat.6A, 100 m		
	USB data throughput	-		280 Mbps max.		

#### Electrical Specifications

Item		Specifications					
		NYM12W-C100□	NYM15W-C100□	NYM19W-C1□0□	NYM12W-C106□	NYM15W-C106□	NYM19W-C1□6□
		DVI-D interface			NY Monitor Link interface		
Rated power supply voltage		24 VDC					
Allowable power supply voltage range		19.2 to 28.8 VDC					
Grounding method		Ground to less than 100 Ω					
Inrush current		At 24 VDC: 5 A / 10 ms max.					
Overvoltage category		JIS B3502 and IEC 61131-2: Category II					
EMC immunity level		IEC 61131-2: Zone B					
Power consumption	Maximum power consumption	25 W max.	25 W max.	37 W max.	30 W max.	31 W max.	44 W max.
	Expansions	USB 5 W max (2 x 500 mA at 5 V), included above.					

## Components and functions

The Industrial Monitor is intended to be used as a display and touch interface for the Industrial PC Platform variants. The Industrial Monitor allows the user to interact through touch interactions on the LCD display.

**Display**

The high resolution and a high brightness provide clarity and high visibility.

**Modern Design**

Winner of iF design award for excellent industrial design.

**Multi-touch functionality**

Up to 5 simultaneous touches to increase operator efficiency by offering a natural user interface.

**Backlit Logo indicator**

The product logo is provided with a controllable backlight to increase visibility.

Unique Customized logo

**Status LED indicator**

The Industrial Monitor includes one LED indicator on the front of the product.

**Mounting method**

Mounting brackets inside the housing with spring mechanism for easy built-in.

**Mechanics**

Solid die-cast aluminum front housing with industrial black coating.



**DVI-D visual interface**

The video interface for the Industrial Monitor is provided with a DVI-D connector for connection to the host PC.

**USB Type-B port for host PC**

The USB Type-B port supports USB2.0 specifications. This port allows the host PC to communicate with multiple internal USB devices within the Industrial Monitor as well as external devices connected to the two USB Type-A ports.

**USB Type-A ports for slave devices**

Two USB Type-A ports are available for connection to external USB devices such as keyboards, memory sticks, or other peripheral hardware.

**Programmable brightness control**

Use the host PC to control the Industrial Monitor's LCD brightness automatically.

**100 m NY Monitor Link port**

Instead of DVI-D and USB-B an NY Monitor Link is available. NY Monitor Link allows high speed video and data communication over 100 mtr via standard Ethernet cable.

## Environmental Specifications

Item		Specifications
Operation environment	Ambient operating temperature	0 to 55°C *1
	Ambient storage temperature	-20 to 70°C *1
	Ambient operating humidity	10% to 90% with no condensation *1
	Ambient storage humidity	10% to 90% with no condensation *1
	Operating atmosphere	No corrosive gases
	Altitude	2,000 m max.
	Pollution degree	2 or less: Conforms to JIS B3502 and IEC 61131-2
	Noise resistance (during operation)	Conforms to IEC61000-4-4, 2kV (power lines)
	Vibration resistance (during operation)	Conforms to IEC 60068-2-6. 5 to 8.4Hz with 3.5 mm single amplitude and 8.4 to 150 Hz with 9.8 m/s <sup>2</sup> for 10 times each in X, Y and Z directions
	Shock resistance (during operation)	Conforms to IEC 60068-2-27. 147 m/s <sup>2</sup> , 3 times in each X, Y and Z directions
	Installation method	Mount on panel
Degree of protection	Front of product: IP65 *2	
Applicable standards *3		EU Directives: EMC Directive 2014/30/EU (EN 61131-2) and RoHS Directive KC Registration, RCM, cULus, EAC

\*1. See *Temperature and Humidity Specifications* on page 6 for details.

\*2. The Industrial Monitor may not operate properly in locations subjected to oil splashes for extended periods of time.

\*3. Refer to the OMRON website ([www.ia.omron.com](http://www.ia.omron.com)) or contact your OMRON representative for the most recent applicable standards for each model.

# Temperature and Humidity Specifications

The allowed ambient temperature and humidity conditions during operation and storage for the Industrial Monitor are specified in the following graphs.

- Operate the Industrial Monitor within the following ambient temperature and humidity ranges.

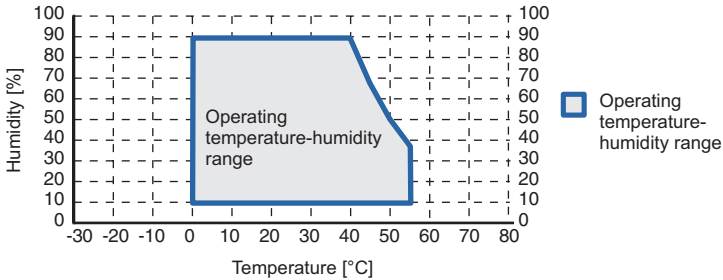

- Store the Industrial Monitor within the following ambient temperature and humidity ranges.

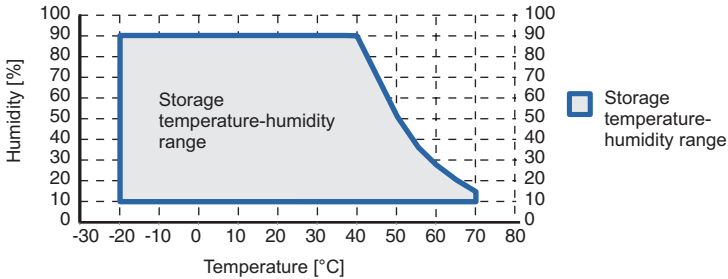

# Monitor Temperature Specifications

Ambient operating temperature specifications for a Monitor

Product Orientation	Mounting Angle	Configuration	
		With a DVI-D interface	With an NY Monitor Link interface
Landscape and Portrait	0° to 45°	0 to 55°C	0 to 50°C
	45° to 90°	0 to 55°C	
Landscape	90° to 135°	0 to 55°C	
	45° to 90°	0 to 55°C	
Portrait	90° to 135°	0 to 55°C	

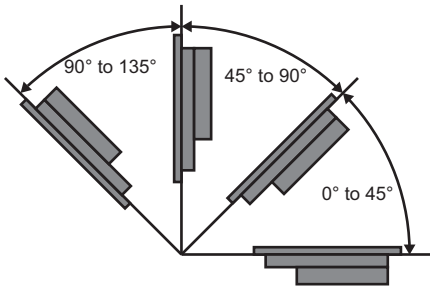

# Dimensions

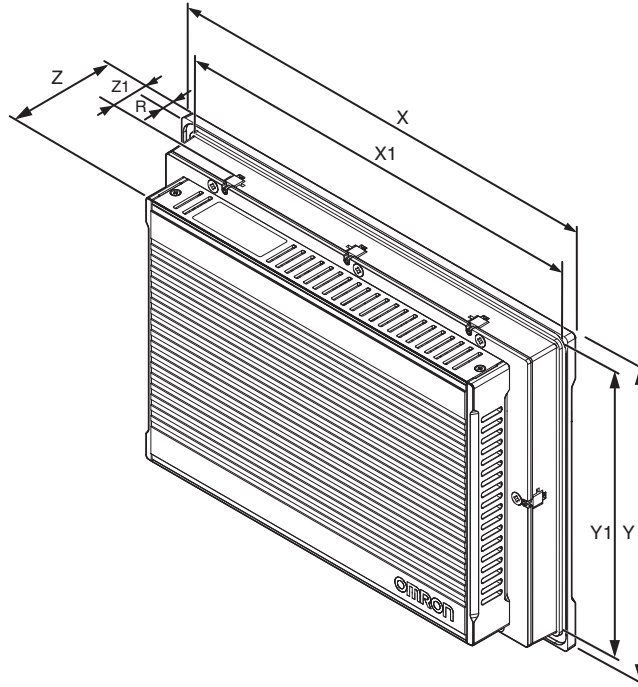

Item	Specifications		
	12.1 inch models	15.4 inch models	18.5 inch models
<b>Panel cutout dimensions</b>	Cutout Width X1 = 314 <sup>-0+1</sup> mm Cutout Height Y1 = 216 <sup>-0+1</sup> mm	Cutout Width X1 = 383 <sup>-0+1</sup> mm Cutout Height Y1 = 259 <sup>-0+1</sup> mm	Cutout Width X1 = 463 <sup>-0+1</sup> mm Cutout Height Y1 = 285 <sup>-0+1</sup> mm
<b>Panel thickness range *</b>	Panel thickness range Z1 = 1.6 to 6.0 mm		
<b>Dimensions</b>	Width X = 332 mm Height Y = 234 mm Depth Z = 66 mm	Width X = 401 mm Height Y = 277 mm Depth Z = 66 mm	Width X = 481 mm Height Y = 303 mm Depth Z = 66 mm
<b>Monitor thickness on top of panel</b>	Rim thickness R = 8.0 mm		
<b>Weight</b>	3.3 kg	4.3 kg	5.3 kg

\* The minimum panel thickness depends on the panel material.

## Recommended Related Products



### Industrial Box PC NY-series

The Industrial Box PC is designed to meet the specific needs of the industrial environment. Design simplification and future-proof architecture minimize the risk of failure.



### Industrial Panel PC NY-series

The Industrial Panel PC intelligently combines the functionality of the Industrial Box PC and Industrial Monitor. No cables are used between the two components, which ensures optimal signal distribution and reliable operation in industrial environments.

## Related Manuals

The following manuals are related. Use these manuals for reference.

Manual name	Cat. No.	Model numbers	Application	Description
Industrial Box PC User's Manual	W553	NYB□□-□□□□□□	Learning all basic information about the Industrial Box PC. This includes introductory information with features, hardware overview, software overview, specifications, mounting, wiring, connecting, operating and maintaining the Industrial Box PC.	An introduction to the Industrial Box PC is provided along with the following information: <ul style="list-style-type: none"> <li>• Overview</li> <li>• Hardware</li> <li>• Software</li> <li>• Specifications</li> <li>• Installation</li> <li>• Operating Procedures</li> <li>• Maintenance</li> </ul>
Industrial Monitor User's Manual	W554	NYM□□W-C10□□	Learning all basic information about the Industrial Monitor. This includes introductory information with features, hardware overview, specifications, mounting, wiring, connecting, operating and maintaining the Industrial Monitor.	An introduction to the Industrial Monitor is provided along with the following information: <ul style="list-style-type: none"> <li>• Overview</li> <li>• Hardware</li> <li>• Software</li> <li>• Specifications</li> <li>• Installation</li> <li>• Operating Procedures</li> <li>• Maintenance</li> </ul>
Industrial Panel PC User's Manual	W555	NYP□□-□□□□□□-□□□□□□□□□□	Learning all basic information about the Industrial Panel PC. This includes introductory information with features, hardware overview, software overview, specifications, mounting, wiring, connecting, operating and maintaining the Industrial Panel PC.	An introduction to the Industrial Panel PC is provided along with the following information: <ul style="list-style-type: none"> <li>• Overview</li> <li>• Hardware</li> <li>• Software</li> <li>• Specifications</li> <li>• Installation</li> <li>• Operating Procedures</li> <li>• Maintenance</li> </ul>



**OMRON AUTOMATION AMERICAS HEADQUARTERS** • Chicago, IL USA • 847.843.7900 • 800.556.6766 • automation.omron.com

**OMRON CANADA, INC. • HEAD OFFICE**

Toronto, ON, Canada • 416.286.6465 • 866.986.6766 • automation.omron.com

**OMRON ELECTRONICS DE MEXICO • HEAD OFFICE**

Ciudad de México • 52.55.5901.4300 • 01.800.386.6766 • mela@omron.com

**OMRON ELECTRONICS DE MEXICO • SALES OFFICE**

San Pedro Garza García, N.L. • 81.12.53.7392 • 01.800.386.6766 • mela@omron.com

**OMRON ELECTRONICS DE MEXICO • SALES OFFICE**

Eugenio Garza Sada, León, Gto • 01.800.386.6766 • mela@omron.com

**OMRON ELETRÔNICA DO BRASIL LTDA • HEAD OFFICE**

São Paulo, SP, Brasil • 55.11.2101.6300 • www.omron.com.br

**OMRON ARGENTINA • SALES OFFICE**

Buenos Aires, Argentina • +54.11.4521.8630 • +54.11.4523.8483  
mela@omron.com

**OTHER OMRON LATIN AMERICA SALES**

+54.11.4521.8630 • +54.11.4523.8483 • mela@omron.com

*Authorized Distributor:*

**Controllers & I/O**

- Machine Automation Controllers (MAC) • Motion Controllers
- Programmable Logic Controllers (PLC) • Temperature Controllers • Remote I/O

**Robotics**

- Industrial Robots • Mobile Robots

**Operator Interfaces**

- Human Machine Interface (HMI)

**Motion & Drives**

- Machine Automation Controllers (MAC) • Motion Controllers • Servo Systems
- Frequency Inverters

**Vision, Measurement & Identification**

- Vision Sensors & Systems • Measurement Sensors • Auto Identification Systems

**Sensing**

- Photoelectric Sensors • Fiber-Optic Sensors • Proximity Sensors
- Rotary Encoders • Ultrasonic Sensors

**Safety**

- Safety Light Curtains • Safety Laser Scanners • Programmable Safety Systems
- Safety Mats and Edges • Safety Door Switches • Emergency Stop Devices
- Safety Switches & Operator Controls • Safety Monitoring/Force-guided Relays

**Control Components**

- Power Supplies • Timers • Counters • Programmable Relays
- Digital Panel Meters • Monitoring Products

**Switches & Relays**

- Limit Switches • Pushbutton Switches • Electromechanical Relays
- Solid State Relays

**Software**

- Programming & Configuration • Runtime