

## High-capacity Switch Capable of Handling 20 A Loads with Large Inrush Currents

- Same shape as OMRON Z Basic Switches except in pin plunger position, yet endures inrush currents as large as 75 A.

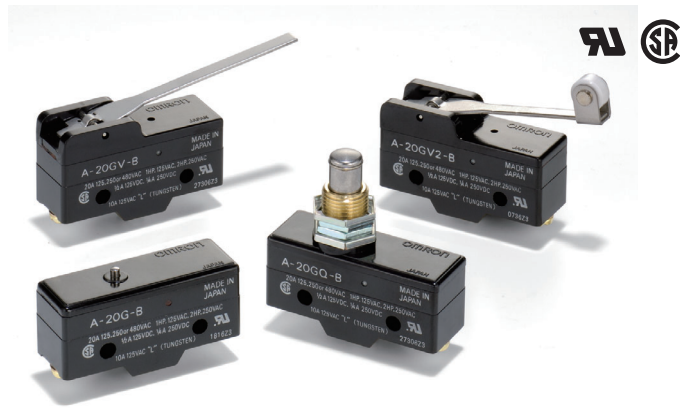

Be sure to read *Safety Precautions* on page 5 and *Safety Precautions for All Basic Switches*.

## Model Number Structure

### Model Number Legend

**A - 20 G □ - □**  
(1) (2) (3) (4)

#### (1) Ratings

20 : 20 A (250 VAC)

#### (2) Contact Gap

G : 0.5 m

#### (3) Actuator

- None : Pin plunger
- D : Short spring plunger
- Q : Panel mount plunger
- Q21 : Panel mount cross roller plunger
- Q22 : Panel mount roller plunger
- V : Hinge lever
- V2 : Hinge roller lever
- V21 : Short hinge lever
- V22 : Short hinge roller lever

#### (4) Terminals

- None : Solder terminal
- B : Screw terminal (with toothed washer)

## Ordering Information

| Actuator                         | Terminal | Solder terminal | Screw terminal (-B) |
|----------------------------------|----------|-----------------|---------------------|
|                                  |          | Model           | Model               |
| Pin plunger                      |          | A-20G           | A-20G-B             |
| Short spring plunger             |          | A-20GD          | A-20GD-B            |
| Panel mount plunger              |          | A-20GQ          | A-20GQ-B            |
| Panel mount roller plunger       |          | A-20GQ22        | A-20GQ22-B          |
| Panel mount cross roller plunger |          | ---             | A-20GQ21-B          |
| Short hinge lever                |          | A-20GV21        | A-20GV21-B          |
| Hinge lever                      |          | A-20GV          | A-20GV-B            |
| Short hinge roller lever         |          | A-20GV22        | A-20GV22-B          |
| Hinge roller lever               |          | A-20GV2         | A-20GV2-B           |

## Specifications

### Ratings

| Rated voltage (V) | Non-inductive load (A) |      |           |    | Inductive load (A) |    |            |    |
|-------------------|------------------------|------|-----------|----|--------------------|----|------------|----|
|                   | Resistive load         |      | Lamp load |    | Inductive load     |    | Motor load |    |
|                   | NC                     | NO   | NC        | NO | NC                 | NO | NC         | NO |
| 125 VAC           | 20                     |      | 7.5       |    | 20                 |    | 12.5       |    |
| 250 VAC           | 20                     |      | 7.5       |    | 20                 |    | 8.3        |    |
| 500 VAC           | 15                     |      | 4         |    | 10                 |    | 2          |    |
| 8 VDC             | 20                     | 3    | 1.5       |    | 20                 |    | 12.5       |    |
| 14 VDC            | 20                     | 3    | 1.5       |    | 15                 |    | 12.5       |    |
| 30 VDC            | 6                      | 3    | 1.5       |    | 5                  |    | 5          |    |
| 125 VDC           | 0.5                    | 0.5  | 0.5       |    | 0.05               |    | 0.05       |    |
| 250 VDC           | 0.25                   | 0.25 | 0.25      |    | 0.03               |    | 0.03       |    |

- Note: 1. The above values are for steady-state current.  
 2. Inductive load has a power factor of 0.4 min. (AC) and a time constant of 7 ms max. (DC).  
 3. Lamp load has an inrush current of 10 times the steady-state current.  
 4. Motor load has an inrush current of 6 times the steady-state current.  
 5. The ratings values apply under the following test conditions:  
 (1) Ambient temperature: 20±2°C  
 (2) Ambient humidity: 65±5%RH  
 (3) Operating frequency: 20 operations/min

### Certified Standard Ratings

Ask your OMRON representative for information on certified models.  
**UL/CSA (General ratings only)**

| Rated voltage | Model | A-20G         |
|---------------|-------|---------------|
| 125 VAC       |       | 1 HP 10 A "L" |
| 250 VAC       |       | 2 HP          |
| 480 VAC       |       | 20 A          |
| 125 VDC       |       | 0.5 A         |
| 250 VDC       |       | 0.25 A        |

**Accessories (Terminal Covers, and Separators): Refer to Z/A/X/DZ Common Accessories.**

## Characteristics

|  |                    |   |
|--|--------------------|---|
| <b>Operating speed</b>                             |                    | 0.01 mm to 1m/s *1  |
| <b>Operating frequency</b>                         | <b>Mechanical</b>  | 240 operations/min  |
|  | <b>Electrical</b>  | 20 operations/min   |
| <b>Insulation resistance</b>                       |                    | 100 MΩ min. (at 500 VDC)  |
| <b>Contact resistance</b>                          |                    | 15 mΩ max. (initial value)  |
| <b>Dielectric strength</b>                         |                    | 1,000 VAC, 50/60 Hz for 1 min between terminals of the same polarity<br>2,000 VAC, 50/60 Hz for 1 min between the current-carrying metal parts and the ground, and between each terminal and non-current-carrying metal parts |
| <b>Vibration resistance</b>                        | <b>Malfunction</b> | 10 to 55 Hz, 1.5-mm double amplitude *2   |
| <b>Shock resistance</b>                            | <b>Destruction</b> | 1,000 m/s <sup>2</sup> max.   |
|  | <b>Malfunction</b> | 300 m/s <sup>2</sup> max. *1 *2   |
| <b>Durability</b>                                  | <b>Mechanical</b>  | 1,000,000 operations min.   |
|  | <b>Electrical</b>  | 500,000 operations min.   |
| <b>Degree of protection</b>                        |                    | IP00  |
| <b>Degree of protection against electric shock</b> |                    | Class I   |
| <b>Proof tracking index (PTI)</b>                  |                    | 175   |
| <b>Ambient operating temperature</b>               |                    | -25°C to 80°C (with no icing)   |
| <b>Ambient operating humidity</b>                  |                    | 35% to 85%RH  |
| <b>Weight</b>                                      |                    | Approx. 22 to 58 g  |

\*1. The value is for the pin plunger. (Contact your OMRON representative for other models.)

\*2. Malfunction: 1 ms max.

## Contact Specification

|                       |                             |              |
|-----------------------|-----------------------------|--------------|
| <b>Contacts</b>       | <b>Shape</b>                | Rivet        |
|                       | <b>Material</b>             | Silver alloy |
|                       | <b>Gap (standard value)</b> | 0.5 mm       |
| <b>Inrush current</b> | <b>NC</b>                   | 75 A max.    |
|                       | <b>NO</b>                   | 75 A max.    |

## Structure

### Contact Form (SPDT)

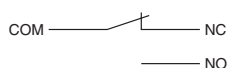

## Dimensions

(Unit: mm)

### Terminals

#### Screw Terminals (-B)

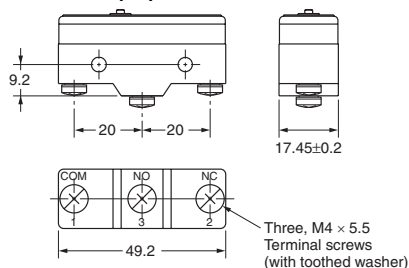

#### Solder Terminal (-A) ("A" is not included in the model numbers.)

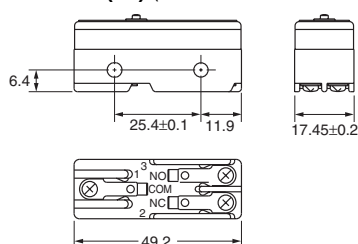

Note: 1. Appropriate terminal screw tightening torque: 0.78 to 1.18 N·m.  
 2. Unless otherwise specified, a tolerance of ±0.4 mm applies to all dimensions.

## Engineering Data

### Mechanical Durability (A-20G)

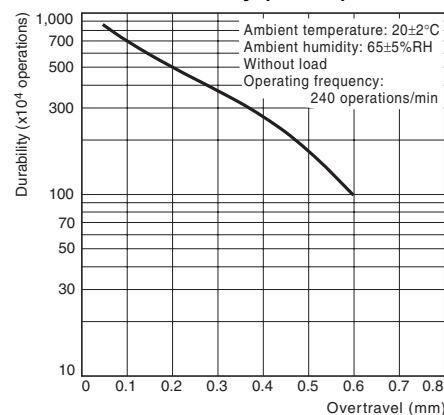

### Electrical Durability (A-20G)

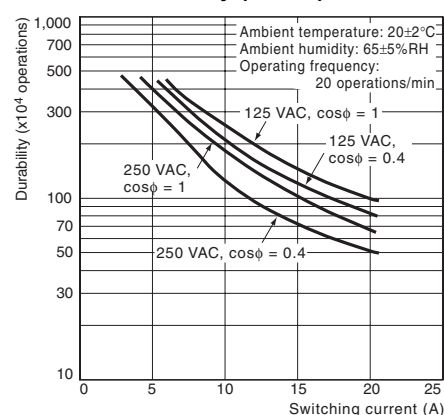

### Mounting Holes

Use M4 mounting screws with plane washers or spring washers to securely mount the Switch. Tighten the screws to a torque of 1.18 to 1.47 N·m.

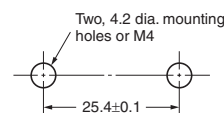

The Switch can be panel mounted, provided that the hexagonal nut of the actuator is tightened to a torque of 2.94 to 4.9 N·m.

#### Panel Mount Plunger

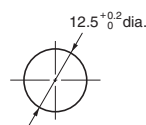

#### Panel Mount Roller Plunger

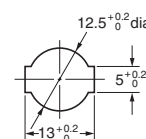

## Dimensions and Operating Characteristics

The models, illustrations, and graphics are for screw-terminal models. (The dimensions for models that are omitted here are the same as for pin-plunger models.)

### Pin Plunger A-20G-B

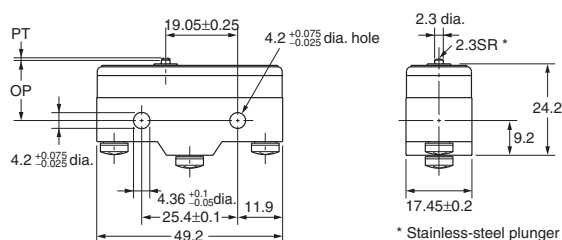
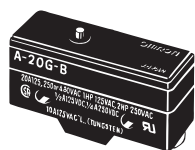

### Short Spring Plunger A-20GD-B

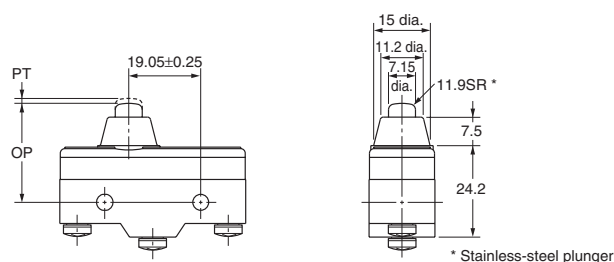
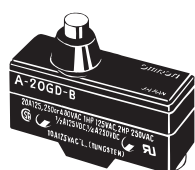

### Panel Mount Plunger A-20GQ-B

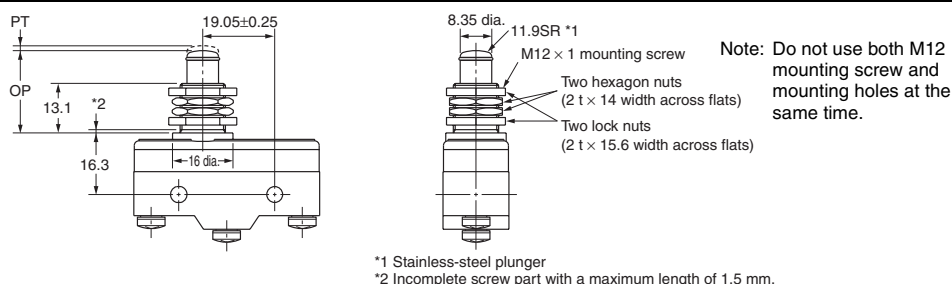
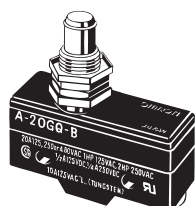

### Panel Mount Roller Plunger A-20GQ22-B

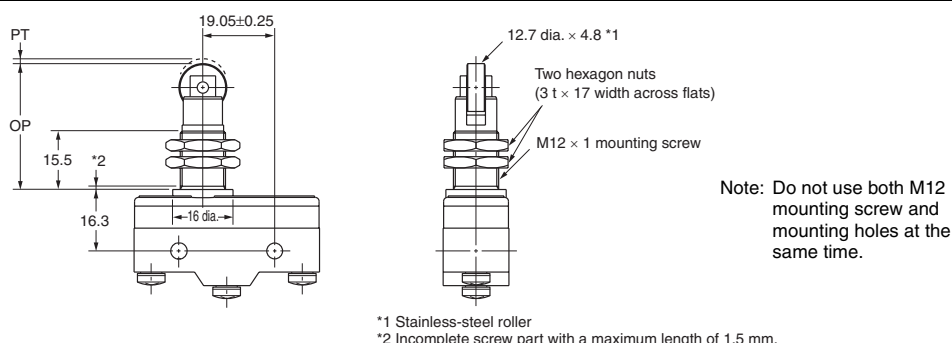
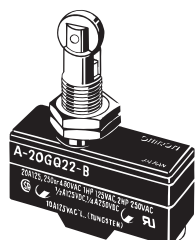

### Panel Mount Cross Roller Plunger A-20GQ21-B

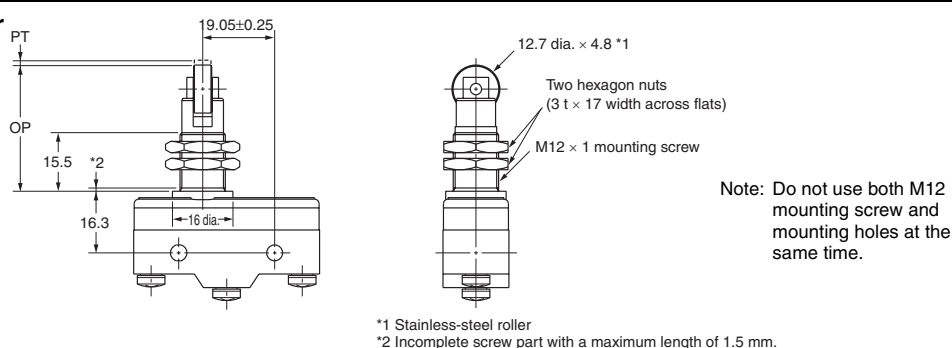
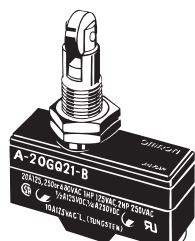

Note: Unless otherwise specified, a tolerance of ±0.4 mm applies to all dimensions.

| Operating Characteristics | Model   | A-20G-B        | A-20GD-B       | A-20GQ-B       | A-20GQ22-B    | A-20GQ21-B    |
|---------------------------|---------|----------------|----------------|----------------|---------------|---------------|
| Operating force           | OF      | 3.92 to 6.13 N | 3.92 to 6.13 N | 3.92 to 6.13 N | 6.18 N max.   | 6.18 N max.   |
| Release force             | RF min. | 2.79 N         | 2.79 N         | 2.79 N         | 2.75 N        | 2.75 N        |
| Pretravel                 | PT max. | 1.3 mm         | 1.3 mm         | 1.3 mm         | 1.3 mm        | 1.3 mm        |
| Over Travel               | OT min. | 0.25 mm        | 3 mm           | 5.6 mm         | 3.58 mm       | 3.58 mm       |
| Movement differential     | MD max. | 0.2 mm         | 0.2 mm         | 0.2 mm         | 0.35 mm       | 0.35 mm       |
| Operating Position        | OP      | 16.3 ± 0.4 mm  | 26.2 ± 0.5 mm  | 21.8 ± 0.8 mm  | 33.4 ± 1.2 mm | 33.4 ± 1.2 mm |

### Short Hinge Lever A-20GV21-B

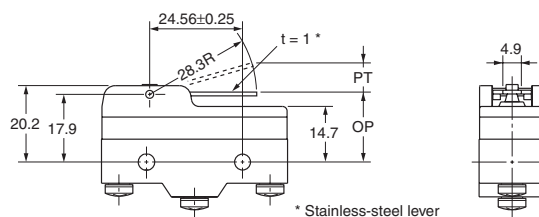
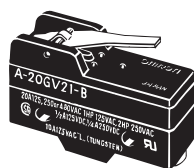

### Hinge Lever A-20GV-B

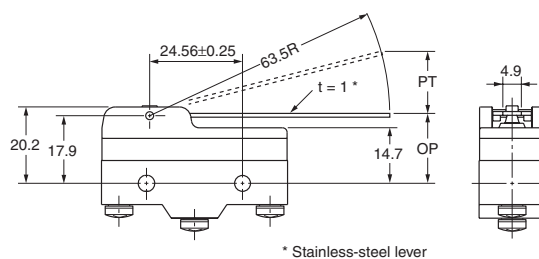
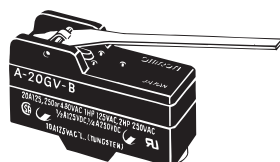

### Short Hinge Roller Lever A-20GV22-B

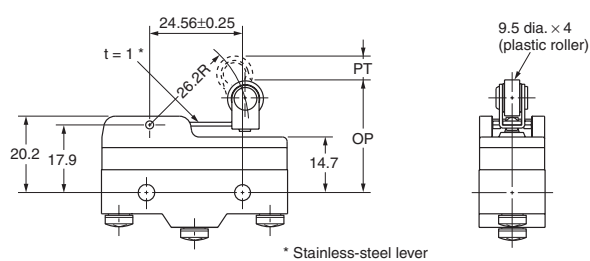

### Hinge Roller Lever A-20GV2-B

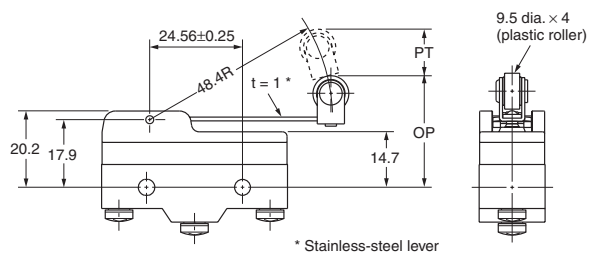
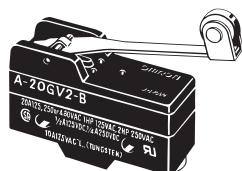

Note: Unless otherwise specified, a tolerance of  $\pm 0.4$  mm applies to all dimensions.

| Operating Characteristics | Model | A-20GV21-B | A-20GV-B  | A-20GV22-B  | A-20GV2-B   |
|---------------------------|-------|------------|-----------|-------------|-------------|
| OF max.                   |       | 1.57 N     | 0.69 N    | 1.57 N      | 0.88 N      |
| RF min.                   |       | 0.41 N     | 0.14 N    | 0.41 N      | 0.14 N      |
| PT max.                   |       | 6.5 mm     | 15.9 mm   | 6.3 mm      | 12 mm       |
| OT min.                   |       | 1.2 mm     | 4 mm      | 1.2 mm      | 2.4 mm      |
| MD max.                   |       | 1.2 mm     | 2.4 mm    | 1.2 mm      | 2.2 mm      |
| OP                        |       | 19±0.8 mm  | 19±0.8 mm | 29.8±0.8 mm | 30.2±0.8 mm |

## Safety Precautions

Refer to *Safety Precautions for All Basic Switches*.

### Precautions for Safe Use

#### Terminal Connection

When soldering lead wires to the Switch, make sure that the capacity of the soldering iron is 60 W maximum. Do not take more than 5 s to solder any part of the Switch. The characteristics of the Switch will deteriorate if a soldering iron with a capacity of more than 60 W is applied to any part of the Switch for 5 s or more.

#### Operation

- Make sure that the switching frequency or speed is within the specified range.
  1. If the switching speed is extremely slow, the contact may not be switched smoothly, which may result in a contact failure or contact welding.
  2. If the switching speed is extremely fast, switching shock may damage the Switch soon. If the switching frequency is too high, the contact may not catch up with the speed.
 The rated permissible switching speed and frequency indicate the switching reliability of the Switch. The life of a Switch is determined at the specified switching speed. The life varies with the switching speed and frequency even when they are within the permissible ranges. In order to determine the life of a Switch model to be applied to a particular use, it is best to conduct an appropriate durability test on some samples of the model under actual conditions.
- Make sure that the actuator travel does not exceed the permissible OT position. The operating stroke must be set to 70% to 100% of the rated OT.

- Do not use the switch in locations subject to hot water (greater than 60°C) or in water vapor.
- Do not use the switch outside the specified temperature and atmospheric conditions.

The permissible ambient temperature depends on the model. (Refer to the specifications in this catalog.) Sudden thermal changes may cause thermal shock to distort the switch and result in faults.

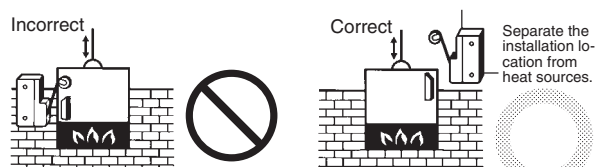

- Mount a cover if the switch is to be installed in a location where worker inattention could result in incorrect operation or accidents.



- Subjecting the switch to continuous vibration or shock may result in contact failure or faulty operation due to abrasion powder and in reduced durability. Excessive vibration or shock will cause the contacts to operate malfunction or become damaged. Mount the switch in a location that is not subject to vibration or shock and in a direction that does not subject the switch to resonance.
- If silver contacts are used with relatively low frequency for a long time or are used with microloads, the sulfide coating produced on the contact surface will not be broken down and contact faults will result. Use a microload switch that uses gold contacts.
- Do not use the switch in atmospheres with high humidity or heat or in harmful gases, such as sulfide gas (H<sub>2</sub>S, SO<sub>2</sub>), ammonia gas (NH<sub>3</sub>), nitric acid gas (HNO<sub>3</sub>), or chlorine gas (Cl<sub>2</sub>). Doing so may impair functionality, such as with damage due to contacting faults or corrosion.
- The switch includes contacts. If the switch is used in an atmosphere with silicon gas, arc energy may cause silicon oxide (SiO<sub>2</sub>) to accumulate on the contacts and result in contact failure. If there is silicon oil, silicon filling, silicon wiring, or other silicon products in the vicinity of the switch, use a contact protection circuit to limit arcing and remove the source of the silicon gas.

### Precautions for Correct Use

#### Mounting Location

- Do not use the switch alone in atmospheres such as flammable or explosive gases. Arcing and heat generation associated with switching may cause fires or explosions.
- Switches are generally not constructed with resistance against water. Use a protective cover to prevent direct spraying if the switch is used in locations subject to splashing or spurting oil or water, dust adhering.

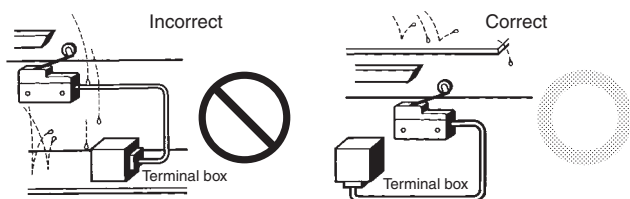

- Install the switch in a location that is not directly subject to debris and dust from cutting. The actuator and the switch body must be protected from accumulated cutting debris and dirt.

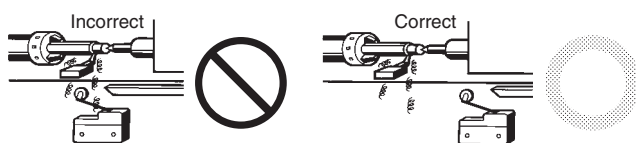

#### Panel-mounting model (A-20G□)

- If a Switch is side-mounted with screws, remove the hexagonal nut of the actuator.
- If a Switch is side-mounted and secured with screws, make sure that the angle or speed of the actuating object is not excessively large or too high, otherwise the Switch may be damaged.
- If a Switch is panel-mounted, pay utmost attention to make sure that the actuating speed or OT distance is not excessively high or large. Not doing so may damage the Switch.

## Accessories (Order Separately)

Refer to Z/A/X/DZ Common Accessories for details about Terminal Covers, Separators, and Actuators.

# Terms and Conditions of Sale

1. **Offer; Acceptance.** These terms and conditions (these "**Terms**") are deemed part of all quotes, agreements, purchase orders, acknowledgments, price lists, catalogs, manuals, brochures and other documents, whether electronic or in writing, relating to the sale of products or services (collectively, the "**Products**") by Omron Electronics LLC and its subsidiary companies ("**Omron**"). Omron objects to any terms or conditions proposed in Buyer's purchase order or other documents which are inconsistent with, or in addition to, these Terms.
2. **Prices; Payment Terms.** All prices stated are current, subject to change without notice by Omron. Omron reserves the right to increase or decrease prices on any unshipped portions of outstanding orders. Payments for Products are due net 30 days unless otherwise stated in the invoice.
3. **Discounts.** Cash discounts, if any, will apply only on the net amount of invoices sent to Buyer after deducting transportation charges, taxes and duties, and will be allowed only if (i) the invoice is paid according to Omron's payment terms and (ii) Buyer has no past due amounts.
4. **Interest.** Omron, at its option, may charge Buyer 1-1/2% interest per month or the maximum legal rate, whichever is less, on any balance not paid within the stated terms.
5. **Orders.** Omron will accept no order less than \$200 net billing.
6. **Governmental Approvals.** Buyer shall be responsible for, and shall bear all costs involved in, obtaining any government approvals required for the importation or sale of the Products.
7. **Taxes.** All taxes, duties and other governmental charges (other than general real property and income taxes), including any interest or penalties thereon, imposed directly or indirectly on Omron or required to be collected directly or indirectly by Omron for the manufacture, production, sale, delivery, importation, consumption or use of the Products sold hereunder (including customs duties and sales, excise, use, turnover and license taxes) shall be charged to and remitted by Buyer to Omron.
8. **Financial.** If the financial position of Buyer at any time becomes unsatisfactory to Omron, Omron reserves the right to stop shipments or require satisfactory security or payment in advance. If Buyer fails to make payment or otherwise comply with these Terms or any related agreement, Omron may (without liability and in addition to other remedies) cancel any unshipped portion of Products sold hereunder and stop any Products in transit until Buyer pays all amounts, including amounts payable hereunder, whether or not then due, which are owing to it by Buyer. Buyer shall in any event remain liable for all unpaid accounts.
9. **Cancellation; Etc.** Orders are not subject to rescheduling or cancellation unless Buyer indemnifies Omron against all related costs or expenses.
10. **Force Majeure.** Omron shall not be liable for any delay or failure in delivery resulting from causes beyond its control, including earthquakes, fires, floods, strikes or other labor disputes, shortage of labor or materials, accidents to machinery, acts of sabotage, riots, delay in or lack of transportation or the requirements of any government authority.
11. **Shipping; Delivery.** Unless otherwise expressly agreed in writing by Omron:
  - a. Shipments shall be by a carrier selected by Omron; Omron will not drop ship except in "break down" situations.
  - b. Such carrier shall act as the agent of Buyer and delivery to such carrier shall constitute delivery to Buyer;
  - c. All sales and shipments of Products shall be FOB shipping point (unless otherwise stated in writing by Omron), at which point title and risk of loss shall pass from Omron to Buyer; provided that Omron shall retain a security interest in the Products until the full purchase price is paid;
  - d. Delivery and shipping dates are estimates only; and
  - e. Omron will package Products as it deems proper for protection against normal handling and extra charges apply to special conditions.
12. **Claims.** Any claim by Buyer against Omron for shortage or damage to the Products occurring before delivery to the carrier must be presented in writing to Omron within 30 days of receipt of shipment and include the original transportation bill signed by the carrier noting that the carrier received the Products from Omron in the condition claimed.
13. **Warranties.** (a) **Exclusive Warranty.** Omron's exclusive warranty is that the Products will be free from defects in materials and workmanship for a period of twelve months from the date of sale by Omron (or such other period expressed in writing by Omron). Omron disclaims all other warranties, express or implied. (b) **Limitations.** OMRON MAKES NO WARRANTY OR REPRESENTATION, EXPRESS OR IMPLIED, ABOUT NON-INFRINGEMENT, MERCHANTABILITY OR FITNESS FOR A PARTICULAR PURPOSE OF THE PRODUCTS. BUYER ACKNOWLEDGES THAT IT ALONE HAS DETERMINED THAT THE PRODUCTS WILL SUITABLY MEET THE REQUIREMENTS OF THEIR INTENDED USE. Omron further disclaims all warranties and responsibility of any type for claims or expenses based on infringement by the Products or otherwise of any intellectual property right. (c) **Buyer Remedy.** Omron's sole obligation hereunder shall be, at Omron's election, to (i) replace (in the form originally shipped with Buyer responsible for labor charges for removal or replacement thereof) the non-complying Product, (ii) repair the non-complying Product, or (iii) repay or credit Buyer an amount equal to the purchase price of the non-complying Product; provided that in no event shall Omron be responsible for warranty, repair, indemnity or any other claims or expenses regarding the Products unless Omron's analysis confirms that the Products were properly handled, stored, installed and maintained and not subject to contamination, abuse, misuse or inappropriate modification. Return of any Products by Buyer must be approved in writing by Omron before shipment. Omron Companies shall not be liable for the suitability or unsuitability or the results from the use of Products in combination with any electrical or electronic components, circuits, system assemblies or any other materials or substances or environments. Any advice, recommendations or information given orally or in writing, are not to be construed as an amendment or addition to the above warranty. See <http://www.omron247.com> or contact your Omron representative for published information.
14. **Limitation on Liability; Etc.** OMRON COMPANIES SHALL NOT BE LIABLE FOR SPECIAL, INDIRECT, INCIDENTAL, OR CONSEQUENTIAL DAMAGES, LOSS OF PROFITS OR PRODUCTION OR COMMERCIAL LOSS IN ANY WAY CONNECTED WITH THE PRODUCTS, WHETHER SUCH CLAIM IS BASED IN CONTRACT, WARRANTY, NEGLIGENCE OR STRICT LIABILITY. Further, in no event shall liability of Omron Companies exceed the individual price of the Product on which liability is asserted.
15. **Indemnities.** Buyer shall indemnify and hold harmless Omron Companies and their employees from and against all liabilities, losses, claims, costs and expenses (including attorney's fees and expenses) related to any claim, investigation, litigation or proceeding (whether or not Omron is a party) which arises or is alleged to arise from Buyer's acts or omissions under these Terms or in any way with respect to the Products. Without limiting the foregoing, Buyer (at its own expense) shall indemnify and hold harmless Omron and defend or settle any action brought against such Companies to the extent based on a claim that any Product made to Buyer specifications infringed intellectual property rights of another party.
16. **Property; Confidentiality.** Any intellectual property in the Products is the exclusive property of Omron Companies and Buyer shall not attempt to duplicate it in any way without the written permission of Omron. Notwithstanding any charges to Buyer for engineering or tooling, all engineering and tooling shall remain the exclusive property of Omron. All information and materials supplied by Omron to Buyer relating to the Products are confidential and proprietary, and Buyer shall limit distribution thereof to its trusted employees and strictly prevent disclosure to any third party.
17. **Export Controls.** Buyer shall comply with all applicable laws, regulations and licenses regarding (i) export of products or information; (ii) sale of products to "forbidden" or other proscribed persons; and (iii) disclosure to non-citizens of regulated technology or information.
18. **Miscellaneous.** (a) **Waiver.** No failure or delay by Omron in exercising any right and no course of dealing between Buyer and Omron shall operate as a waiver of rights by Omron. (b) **Assignment.** Buyer may not assign its rights hereunder without Omron's written consent. (c) **Law.** These Terms are governed by the law of the jurisdiction of the home office of the Omron company from which Buyer is purchasing the Products (without regard to conflict of law principles). (d) **Amendment.** These Terms constitute the entire agreement between Buyer and Omron relating to the Products, and no provision may be changed or waived unless in writing signed by the parties. (e) **Severability.** If any provision hereof is rendered ineffective or invalid, such provision shall not invalidate any other provision. (f) **Setoff.** Buyer shall have no right to set off any amounts against the amount owing in respect of this invoice. (g) **Definitions.** As used herein, "including" means "including without limitation"; and "Omron Companies" (or similar words) mean Omron Corporation and any direct or indirect subsidiary or affiliate thereof.

## Certain Precautions on Specifications and Use

1. **Suitability of Use.** Omron Companies shall not be responsible for conformity with any standards, codes or regulations which apply to the combination of the Product in the Buyer's application or use of the Product. At Buyer's request, Omron will provide applicable third party certification documents identifying ratings and limitations of use which apply to the Product. This information by itself is not sufficient for a complete determination of the suitability of the Product in combination with the end product, machine, system, or other application or use. Buyer shall be solely responsible for determining appropriateness of the particular Product with respect to Buyer's application, product or system. Buyer shall take application responsibility in all cases but the following is a non-exhaustive list of applications for which particular attention must be given: (i) Outdoor use, uses involving potential chemical contamination or electrical interference, or conditions or uses not described in this document. (ii) Use in consumer products or any use in significant quantities. (iii) Energy control systems, combustion systems, railroad systems, aviation systems, medical equipment, amusement machines, vehicles, safety equipment, and installations subject to separate industry or government regulations. (iv) Systems, machines and equipment that could present a risk to life or property. Please know and observe all prohibitions of use applicable to this Product. NEVER USE THE PRODUCT FOR AN APPLICATION INVOLVING SERIOUS RISK TO LIFE OR PROPERTY OR IN LARGE QUANTITIES WITHOUT ENSURING THAT THE SYSTEM AS A WHOLE HAS BEEN DESIGNED TO ADDRESS THE RISKS, AND THAT THE OMRON'S PRODUCT IS PROPERLY RATED AND INSTALLED FOR THE INTENDED USE WITHIN THE OVERALL EQUIPMENT OR SYSTEM.
2. **Programmable Products.** Omron Companies shall not be responsible for the user's programming of a programmable Product, or any consequence thereof.
3. **Performance Data.** Data presented in Omron Company websites, catalogs and other materials is provided as a guide for the user in determining suitability and does not constitute a warranty. It may represent the result of Omron's test conditions, and the user must correlate it to actual application requirements. Actual performance is subject to the Omron's Warranty and Limitations of Liability.
4. **Change in Specifications.** Product specifications and accessories may be changed at any time based on improvements and other reasons. It is our practice to change part numbers when published ratings or features are changed, or when significant construction changes are made. However, some specifications of the Product may be changed without any notice. When in doubt, special part numbers may be assigned to fix or establish key specifications for your application. Please consult with your Omron's representative at any time to confirm actual specifications of purchased Product.
5. **Errors and Omissions.** Information presented by Omron Companies has been checked and is believed to be accurate; however, no responsibility is assumed for clerical, typographical or proofreading errors or omissions.



---

**OMRON INDUSTRIAL AUTOMATION • THE AMERICAS HEADQUARTERS**

Schaumburg, IL USA • 847.843.7900 • 800.556.6766 • [www.omron247.com](http://www.omron247.com)

**OMRON CANADA, INC. • HEAD OFFICE**

Toronto, ON, Canada • 416.286.6465 • 866.986.6766 • [www.omron247.com](http://www.omron247.com)

**OMRON ELECTRONICS DE MEXICO • HEAD OFFICE**

México DF • 52.55.59.01.43.00 • 001.800.556.6766 • [mela@omron.com](mailto:mela@omron.com)

**OMRON ELECTRONICS DE MEXICO • SALES OFFICE**

Apodaca, N.L. • 52.81.11.56.99.20 • 001.800.556.6766 • [mela@omron.com](mailto:mela@omron.com)

**OMRON ELETRÔNICA DO BRASIL LTDA • HEAD OFFICE**

São Paulo, SP, Brasil • 55.11.2101.6300 • [www.omron.com.br](http://www.omron.com.br)

**OMRON ARGENTINA • SALES OFFICE**

Cono Sur • 54.11.4783.5300

**OMRON CHILE • SALES OFFICE**

Santiago • 56.9.9917.3920

**OTHER OMRON LATIN AMERICA SALES**

54.11.4783.5300

---

**OMRON EUROPE B.V.** • Wegalaan 67-69, NL-2132 JD, Hoofddorp, The Netherlands. • Tel: +31 (0) 23 568 13 00

Fax: +31 (0) 23 568 13 88 • [www.industrial.omron.eu](http://www.industrial.omron.eu)