

## EE-SPX302/402/304/404/305/405/306/406-W2A

Prewired Compact Sensing Head for Easy Mounting in Space-Confined Areas

- Light modulation effectively reduces external light interference
- Easy-to-use photomicrosensor with cable attached
- Wide operating voltage range: 5 to 24 VDC
- Optical axis monitoring with a Light-ON indicator
- Amplifier's NPN output can be directly connected to a TTL and programmable controller (PLC)
- Incorporating dust-proof slit
- Detecting an object with 0.5 mm dia.

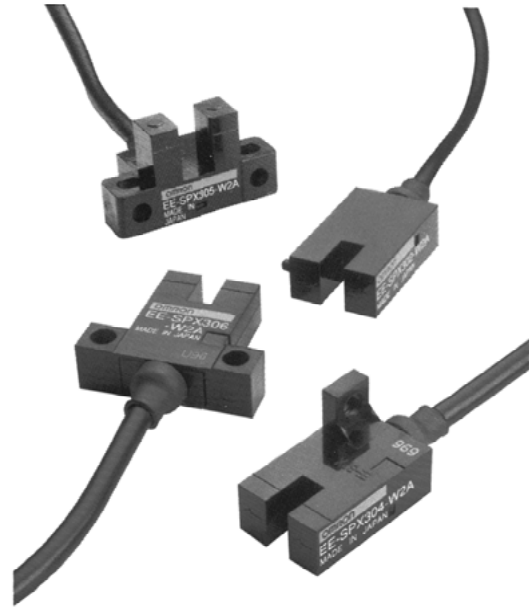

### Ordering Information

Appearance	Sensing Method	Slot width	Slot depth	Output configuration	Weight	Part number
	Slot	3.6 mm	6.6 mm	Dark-ON	Approx. 18.5 g (including lead wires)	EE-SPX302-W2A
				Light-ON		EE-SPX402-W2A
		3.6 mm	6.6 mm	Dark-ON		EE-SPX304-W2A
				Light-ON		EE-SPX404-W2A
		5 mm	9 mm	Dark-ON		EE-SPX305-W2A
				Light-ON		EE-SPX405-W2A
		3.6 mm	6.6 mm	Dark-ON		EE-SPX306-W2A
				Light-ON		EE-SPX406-W2A

# Specifications

## ■ RATINGS

Model		EE-SPX302-W2A EE-SPX304-W2A	EE-SPX402-W2A EE-SPX404-W2A	EE-SPX305-W2A EE-SPX306-W2A	EE-SPX405-W2A EE-SPX406-W2A
Supply voltage		5 to 24 VDC ±10%, ripple (p-p): 5% max.			
Current consumption		Average: 15 mA max.; Peak: 50 mA max.			
Standard reference object		Opaque: 0.5 x 1 mm min.		Opaque: 0.8 x 2 mm min. (See Note 1.)	
Differential distance		0.05 mm max.			
Control output		At 5 to 24 VDC: 80-mA load current ( $I_C$ ) with a residual voltage of 1.0 V max. When driving TTL: 10-mA load current ( $I_C$ ) with a residual voltage of 0.4 V max.			
Output configuration	Transistor on output stage without detecting object	OFF	ON	OFF	ON
	Transistor on output stage with detecting object	ON	OFF	ON	OFF
Indicator (See Note 2.)	Without detecting object	ON			
	With detecting object	OFF			
Response frequency (See Note 3.)		500 Hz			
Connecting method		Cable length: 1 m long cable (attached)			
Light source		GaAs infrared LED (pulse-modulated) with a wavelength of 940 nm			
Receiver		Si photodiode with a sensing wavelength of 850 nm max.			

- Note: 1. EE-SPX306-W2A and EE-SPX406-W2A can detect opaque objects as small as 0.5 x 1.0 mm.  
 2. The indicator is made of a GaP red LED (peak emission wavelength: 700 nm).  
 3. The response frequency was measured by detecting the following disks rotating.

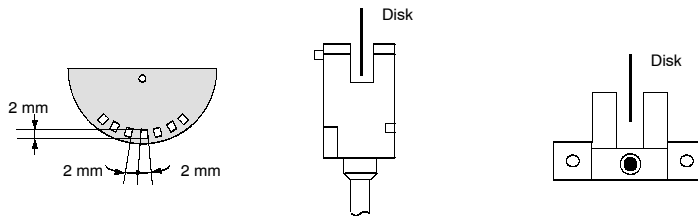

## ■ CHARACTERISTICS

Ambient illumination		Sensing face: fluorescent light/incandescent light: 3,000 lx max.
Enclosure ratings		IP50 (except terminals)
Ambient temperature	Operating	-10°C to 55°C (14°F to 131°F)
	Storage	-25°C to 65°C (-13°F to 149°F)
Ambient humidity	Operating	35% to 85%
	Storage	35% to 95%
Vibration resistance		Destruction: 10 to 55 Hz, 1.5-mm double amplitude for 2 hrs each in X, Y, and Z directions
Shock resistance		Destruction: 500 m/s <sup>2</sup> (approx. 50G) for 3 times each in X, Y, and Z directions
Cable length		2 m max. (including attached cable, AWG22 min.)

# Engineering Data

## ■ SENSING POSITION CHARACTERISTICS (TYPICAL)

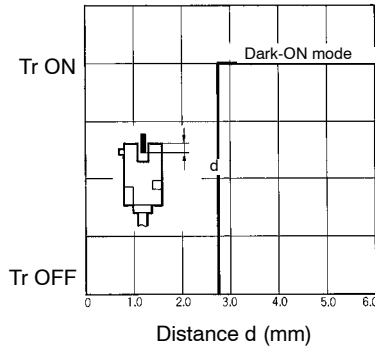
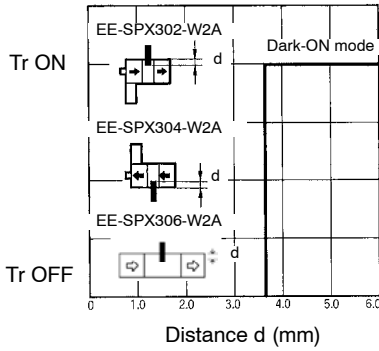

Note: The sensing position characteristics of the EE-SPX402/404/406-W2A are opposite to those of EE-SPX302/304/306-W2A.

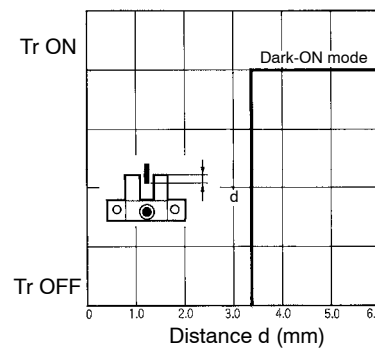
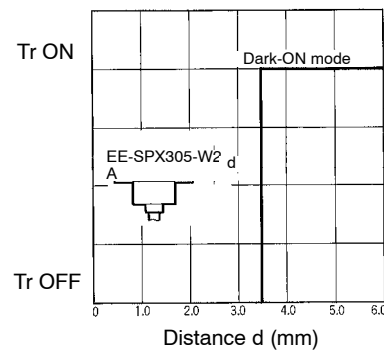

Note: The sensing position characteristics of the EE-SPX405-W2A are opposite to those of EE-SPX305-W2A.

## Operation

### ■ INTERNAL/EXTERNAL CIRCUIT DIAGRAM

#### Light-ON/Dark-ON

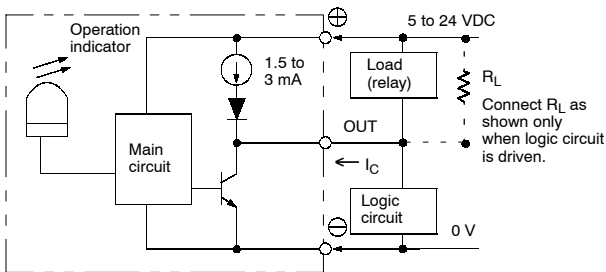

Connect a diode in parallel to the load when an inductive load is connected between + and OUT.

### ■ TIMING CHART

#### Light-ON

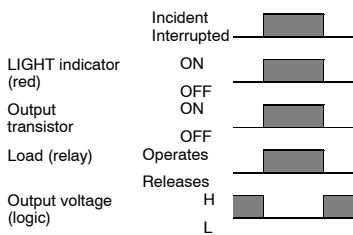

#### Dark-ON

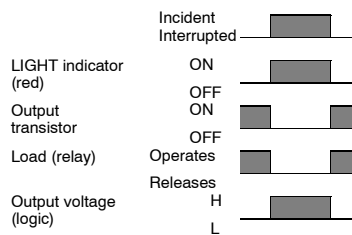

# Dimensions

Unit: mm (inch)

## ■ EE-SPX302-W2A, EE-SPX402-W2A

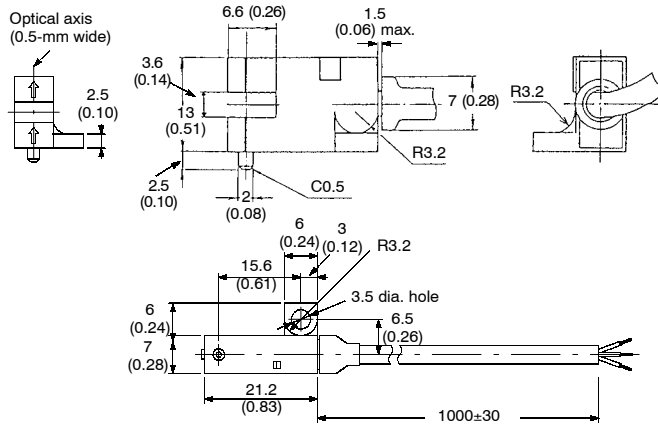

### Terminal Arrangement

Red (Brown)	V <sub>CC</sub>
White (Black)	OUTPUT
Black (Blue)	GND (0 V)

IEC colors are shown in parentheses.

## ■ EE-SPX304-W2A, EE-SPX404-W2A

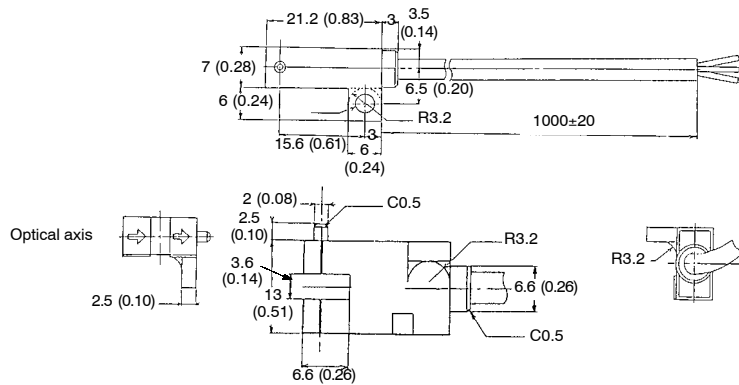
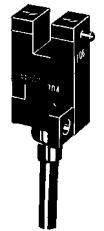

### Terminal Arrangement

Red (Brown)	V <sub>CC</sub>
White (Black)	OUTPUT
Black (Blue)	GND (0 V)

IEC colors are shown in parentheses.

## ■ EE-SPX305-W2A, EE-SPX405-W2A

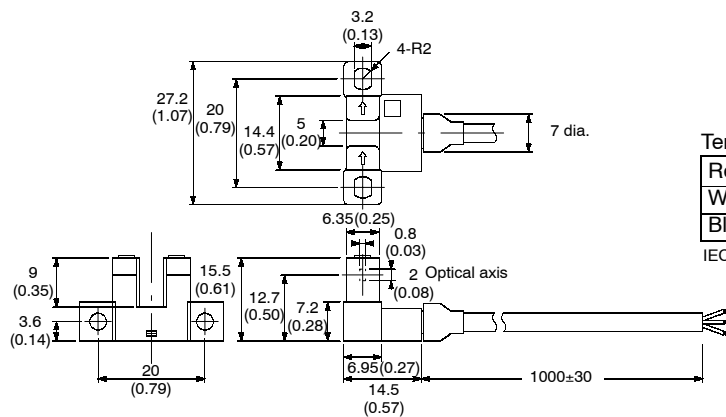
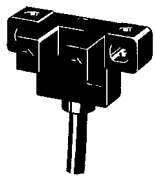

### Terminal Arrangement

Red (Brown)	V <sub>CC</sub>
White (Black)	OUTPUT
Black (Blue)	GND (0 V)

IEC colors are shown in parentheses.

■ EE-SPX306-W2A, EE-SPX406-W2A

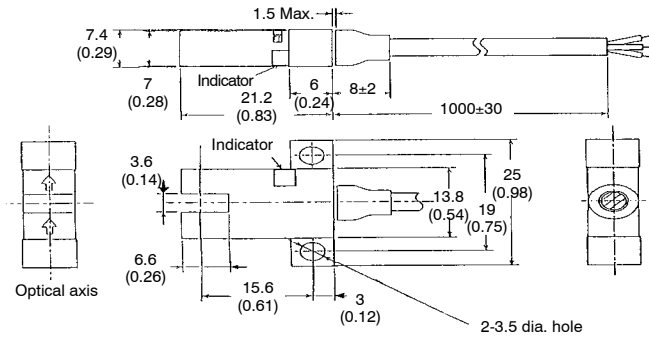

Terminal Arrangement

Red (Brown)	V <sub>CC</sub>
White (Black)	OUTPUT
Black (Blue)	GND (0 V)

IEC colors are shown in parentheses.

## Precautions

Refer to the Technical Information Section for general precautions.

### ■ WIRING

A cable with a thickness of 0.3 mm<sup>2</sup> min. or AWG22 and a length of 2 m max. must be connected to the output terminals.

To use a cable longer than 2 m, attach a capacitor with a capacitance of approximately 10 μF to the wires, as shown below. The distance between the terminal and the capacitor must be 2 m or less:

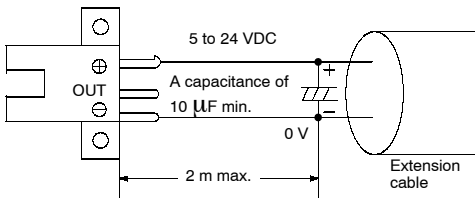

Avoid disconnecting from the photomicrosensor when power is supplied to the photomicrosensor or the photomicrosensor could be damaged.

If the metal mounting base is subjected to inductive electrical noise, the photomicrosensor can be activated accidentally. If noise is a problem, take the following precautions:

1. Connect the GND terminal to the mounting base, so there will be no difference in electric potential between the photomicrosensor and mounting base.

2. Connect the GND terminal to the mounting base via a 0.47-μF capacitor.
3. Insert a plastic insulating plate with a thickness of approximately 10 mm between the photomicrosensor and mounting base.

Wire, as shown by the following illustration, to connect a small inductive load (a relay for example) to the photomicrosensor. A diode must be connected parallel to the relay to absorb the reverse voltage.

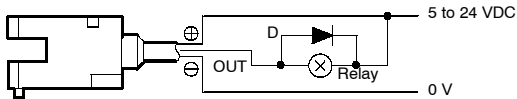

### ■ POWER SUPPLY

When using a standard switching regulator, ground the FG and G terminal so that the photomicrosensor will be in a stable operating condition.

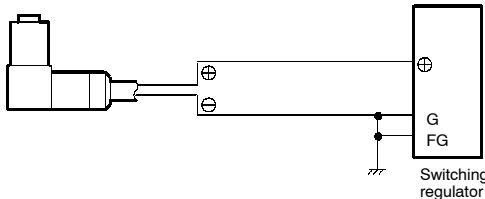

**NOTE: DIMENSIONS SHOWN ARE IN MILLIMETERS. To convert millimeters to inches divide by 25.4.**

**OMRON**<sup>®</sup>  
**OMRON ELECTRONICS LLC**  
 One East Commerce Drive  
 Schaumburg, IL 60173  
**1-800-55-OMRON**

**OMRON ON-LINE**  
 Global - <http://www.omron.com>  
 USA - <http://www.omron.com/oei>  
 Canada - <http://www.omron.com/oci>

**OMRON CANADA, INC.**  
 885 Milner Avenue  
 Toronto, Ontario M1B 5V8  
**416-286-6465**