

NS-Series

NS15-TX01□-V2

NS12-TS00□-V1/-V2, NS12-TS01□-V1/-V2

NS10-TV00□-V1/-V2, NS10-TV01□-V1/-V2

NS8-TV00□-V1/-V2, NS8-TV01□-V1/-V2

NS8-TV10□-V1, NS8-TV11□-V1

NS5-SQ00□-V1/-V2, NS5-SQ01□-V1/-V2

NS5-TQ00□-V2, NS5-TQ01□-V2

NS5-MQ00□-V2, NS5-MQ01□-V2

NS5-SQ10□-V2, NS5-SQ11□-V2

NS5-TQ10□-V2, NS5-TQ11□-V2

NS5-MQ10□-V2, NS5-MQ11□-V2

Programmable Terminals

SETUP MANUAL

OMRON

©OMRON, 2003

All rights reserved. No part of this publication may be reproduced, stored in a retrieval system, or transmitted, in any form, or by any means, mechanical, electronic, photocopying, recording, or otherwise, without the prior written permission of OMRON.

No patent liability is assumed with respect to the use of the information contained herein. Moreover, because OMRON is constantly striving to improve its high-quality products, the information contained in this manual is subject to change without notice. Every precaution has been taken in the preparation of this manual. Nevertheless, OMRON assumes no responsibility for errors or omissions. Neither is any liability assumed for damages resulting from the use of the information contained in this publication.

Trademarks

- Microsoft, and Windows are either registered trademarks or trademarks of Microsoft Corporation in the United States and other countries.
 - ODVA, CIP, CompoNet, DeviceNet, and EtherNet/IP are trademarks of ODVA.
 - This product includes software developed by the Apache Software Foundation (<http://www.apache.org/>).
- Other company names and product names in this document are the trademarks or registered trademarks of their respective companies.

Notice

OMRON products are manufactured for use according to proper procedures by a qualified operator and only for the purposes described in this manual.

The following conventions are used to indicate and classify precautions in this manual. Always heed the information provided with them. Failure to heed precautions can result in injury to people or damage to property.

 **DANGER** Indicates an imminently hazardous situation which, if not avoided, will result in death or serious injury. Additionally, there may be severe property damage.

 **WARNING** Indicates a potentially hazardous situation which, if not avoided, could result in death or serious injury. Additionally, there may be severe property damage.

 **Caution** Indicates a potentially hazardous situation which, if not avoided, may result in minor or moderate injury, or property damage.

OMRON Product References

All OMRON products are capitalized in this manual. The word "Unit" is also capitalized when it refers to an OMRON product, regardless of whether or not it appears in the proper name of the product.

The abbreviation "Ch," which appears in some displays and on some OMRON products, often means "word" and is abbreviated "Wd" in documentation in this sense.

The abbreviation "PLC" means Programmable Controller.

The abbreviation "host" means a controller, such as an IBM PC/AT or compatible computer, that controls a PT (Programmable Terminal).

Visual Aids

The following headings appear in the left column of the manual to help you locate different types of information.

Precautions for Safe Use

Indicates precautions on handling the product to ensure that the product is used safely.

Precautions for Correct Use

Indicates precautions to ensure that product functions and performances are realized, to ensure that the reliability of the product is maintained, and to ensure that the product is otherwise used correctly.

Note

Indicates information of particular interest for efficient and convenient operation of the product.

Reference

Indicates supplementary information on procedures, descriptions, and settings.

1, 2, 3...

1. Indicates lists of one sort or another, such as procedures, checklists, etc.

CS1G-CPU□□-V1

Boxes in model numbers indicate variable characters. For example, "CS1G-CPU□□-EV1" indicates the following models: CS1G-CPU42-EV1, CS1G-CPU43-EV1, CS1G-CPU44-EV1, and CS1G-CPU45-EV1.

Contents

Notice	1
About this Manual	7
Related Manuals	8
Terminology	9
Introduction	10
Section 1 Overview	1-1
1-1 NS-series PT Functions and Operation.....	1-2
1-1-1 PT Functions for FA Manufacturing Sites	1-2
1-1-2 NS-series PT Operating System.....	1-3
1-2 Communications with the Host	1-5
1-2-1 What is an NT Link?.....	1-6
1-2-2 Ethernet	1-6
1-2-3 Controller Link.....	1-6
1-2-4 Host Link	1-6
1-2-5 Connecting to a Temperature Controller.....	1-6
1-2-6 Memory Link Connections	1-7
1-2-7 Communicating with Other Devices	1-7
1-2-8 EtherNet/IP	1-7
1-3 System Configuration.....	1-8
1-3-1 Supported Peripheral Devices	1-8
1-4 Procedure for Running NS-series PTs	1-10
Section 2 Before Connecting	2-1
2-1 Connecting the Host	2-2
2-1-1 Communications Types and Connection Methods.....	2-2
2-2 Part Names and Functions	2-8
Section 3 Installing the PT and Connecting Peripheral Devices	3-1
3-1 Installing the PT	3-3
3-1-1 Installation Environment.....	3-3
3-1-2 Installing RS-232C/RS-422A Converters	3-3
3-1-3 Mounting the PT to the Control Panel	3-4
3-1-4 Connecting the Power Supply	3-7
3-1-5 Wiring the Ground Wire	3-8
3-1-6 Peripheral Device Connection Limitations	3-8
3-2 Starting the PT	3-10
3-2-1 Operation at Startup	3-10
3-2-2 Starting the PT for the First Time	3-12
3-3 Connecting the CX-Designer.....	3-14
3-3-1 Connecting via RS-232C or Ethernet.....	3-14
3-3-2 Connecting via USB.....	3-14
3-3-3 Connecting via a Modem	3-16
3-4 Connecting to Bar Code Readers.....	3-17
3-4-1 Connection Methods	3-17
3-4-2 Setting Bar Code Readers	3-18

3-4-3	Data Format	3-19
3-4-4	Bar Code Input.....	3-19
3-5	Connecting to Printers	3-20
3-5-1	Connecting to a Printer Compatible with ESC/P Raster and BJ Raster	3-20
3-5-2	Connecting a PictBridge-compatible Printer.....	3-21
3-6	Using Memory Cards.....	3-23
3-6-1	Installation.....	3-24
3-6-2	Replacing the System Program	3-25
3-6-3	Transferring Data with Memory Cards	3-26
3-7	Installing the Video Input Unit.....	3-32
3-7-1	Video Input Unit Components	3-32
3-7-2	Nomenclature and Functions.....	3-33
3-7-3	Installation Method for Video Input Unit	3-34
3-7-4	Connecting to Video Input Connectors.....	3-39
3-8	Installing the Controller Link Interface Unit	3-44
3-8-1	Controller Link Interface Unit Components	3-44
3-8-2	Nomenclature and Functions.....	3-45
3-8-3	Installation Method for Controller Link Interface Unit.....	3-48
3-8-4	Wiring.....	3-55
3-9	Connecting a Monitor.....	3-61
3-10	External Brightness Adjustment.....	3-62
3-11	RS-232C/RS-422A Selector DIP Switch.....	3-63
Section 4	Connecting the Host to Serial Port.....	4-1
4-1	1:1 Host Connection	4-2
4-1-1	Connection Methods	4-2
4-1-2	Unit Setting Methods	4-4
4-2	1:N Host Connection	4-7
4-2-1	Connection Methods	4-7
4-2-2	Unit Setting Methods	4-7
4-3	High-speed 1:N NT Link.....	4-18
4-3-1	Unit Setting Methods	4-19
4-4	Recommended Connector Cables.....	4-27
Section 5	Connecting to Host via Ethernet or Controller Link.....	5-1
5-1	Connecting to Host Via Ethernet.....	5-2
5-1-1	Host Types and Settings.....	5-3
5-2	Connecting to the Host Using Controller Link.....	5-16
5-2-1	What Is a Controller Link Network?.....	5-16
5-2-2	Data Links.....	5-17
5-2-3	Troubleshooting Using Indicators.....	5-22
5-3	Connecting to Host via EtherNet/IP	5-25
5-3-1	What is EtherNet/IP?	5-25
5-3-2	Selecting Network Configuration Devices.....	5-26
5-3-3	Network Installation.....	5-29
5-3-4	Host Types and Settings.....	5-31

Section 6	System Menu Operations	6-1
6-1	Operating Modes and System Menu.....	6-4
6-1-1	Mode Configuration.....	6-4
6-1-2	System Menu Configuration	6-4
6-1-3	Overview of Menu Items	6-5
6-1-4	Using the System Menu	6-8
6-2	Initializing and Saving Data and Removing the Memory Card.....	6-11
6-2-1	Screen Data Area Format.....	6-12
6-2-2	Initializing or Saving the Alarm/Event History	6-13
6-2-3	Initializing and Saving Data Log	6-15
6-2-4	Initializing and Saving the Operation Log	6-16
6-2-5	Initializing and Saving the Error Log.....	6-18
6-2-6	Language Selection.....	6-19
6-2-7	Removing the Memory Card.....	6-20
6-2-8	Initializing Internal Holding Memories (\$HB/\$HW).....	6-21
6-3	PT Settings	6-22
6-3-1	Start-up Wait Time.....	6-26
6-3-2	Screen Saver.....	6-27
6-3-3	Key Press Sound	6-28
6-3-4	Buzzer Sound.....	6-28
6-3-5	Backlight Brightness	6-29
6-3-6	Calendar Check.....	6-32
6-3-7	Printer Type	6-33
6-3-8	Printing Mode	6-33
6-3-9	Orientation	6-34
6-3-10	Changing Values in Device Monitor Setting	6-34
6-3-11	Contrast (NS5-SQ□□/NS5-MQ□□ Only)	6-34
6-3-12	CJK Han Unification Priority.....	6-35
6-3-13	Alarm Monitor Registration Procedure.....	6-35
6-3-14	Starting the Ladder Monitor from Alarm/Event Summary and History (NS15/12/10/8 Only)	6-36
6-3-15	Setting the Tag Update Notification Message.....	6-36
6-3-16	Time to Switch to System Menu (NS12, NS10, NS8, or NS5).....	6-36
6-3-17	Double-touch Interval (NS15 Only).....	6-37
6-3-18	Analog RGB Output (NS15 only).....	6-37
6-4	Project Settings.....	6-38
6-4-1	Project Title.....	6-38
6-4-2	Number of Labels.....	6-39
6-4-3	Initial Screen	6-39
6-4-4	Initial Label.....	6-39
6-4-5	Barcode Input When Using Keypad.....	6-39
6-4-6	Alarm/Event History Recording Method	6-39
6-4-7	Data Log Recording Method.....	6-40
6-4-8	Operation Log Recording Method	6-40
6-4-9	Error Log Recording Method.....	6-40
6-4-10	System Memory	6-40

6-5	Setting Passwords.....	6-41
6-5-1	Changing the Password.....	6-41
6-5-2	Setting the Password Function.....	6-42
6-6	Communications Settings.....	6-44
6-6-1	Communications Conditions.....	6-44
6-6-2	Setting 1:1 NT Link.....	6-46
6-6-3	Setting High-speed 1:N NT Links (Standard, High-speed).....	6-47
6-6-4	Ethernet and EtherNet/IP Settings.....	6-47
6-6-5	Setting the Controller Link Network.....	6-50
6-6-6	Setting Bar Code Readers.....	6-51
6-6-7	Modem Settings.....	6-52
6-7	Screen Data Check.....	6-53
6-8	Special Screens.....	6-54
6-8-1	Alarm History.....	6-55
6-8-2	Operation Log.....	6-56
6-8-3	Error Log.....	6-57
6-8-4	Device Monitor.....	6-58
6-8-5	Communication Test.....	6-60
6-8-6	Video Configuration.....	6-62
6-8-7	USB Device List.....	6-64
6-8-8	Display Capture Data.....	6-65
6-8-9	Memory Card Transfers.....	6-66
6-8-10	External Application Startup.....	6-68
6-8-11	Version Display.....	6-69
6-8-12	PLC Data Trace (NS15, NS12, NS10, and NS8 Only).....	6-69
6-8-13	NJ-series Troubleshooter.....	6-71
6-9	Hardware Check.....	6-72
6-9-1	LCD Check.....	6-72
6-9-2	Touch Switch Check.....	6-73
6-9-3	Touch Panel Calibration (NS15 Only).....	6-73
6-10	Starting Operations.....	6-74
6-11	Verifying Tags.....	6-76
Section 7	Maintenance and Troubleshooting.....	7-1
7-1	Maintenance.....	7-2
7-1-1	Replacing the Battery.....	7-2
7-2	Inspection and Cleaning.....	7-4
7-3	Troubleshooting and Maintenance.....	7-6
7-4	Requesting a Replacement PT.....	7-14

Appendices	A-1
Appendix 1 Specifications.....	A-3
A-1-1 General Specifications	A-3
A-1-2 Characteristics.....	A-5
A-1-3 Communications Specifications.....	A-8
Appendix 2 Dimensions	A-12
Appendix 3 Using NS-AL002 Converters.....	A-21
A-3-1 Dimensions	A-21
A-3-2 Mounting and Removing	A-22
A-3-3 Specifications.....	A-22
A-3-4 DIP Switch Settings	A-23
A-3-5 Pin Arrangement	A-24
A-3-6 Handling the Shield on RS-422A/485 Cables.....	A-25
A-3-7 Connection Example.....	A-28
Appendix 4 Using NT-AL001 Converters.....	A-29
A-4-1 Dimensions	A-29
A-4-2 Methods for Mounting and Removal	A-29
A-4-3 Specifications.....	A-31
A-4-4 DIP Switch Settings	A-32
A-4-5 Pin Arrangement	A-33
A-4-6 Block Diagram.....	A-34
Appendix 5 Preparing Connecting Cables.....	A-35
A-5-1 Cable Preparation.....	A-35
A-5-2 Soldering.....	A-36
A-5-3 Hood Assembly.....	A-36
A-5-4 Preparing Connecting Cables for Host Connection	A-37
Appendix 6 Preparing Cables for Computer Connection	A-41
A-6-1 Connecting Cable Assembly.....	A-41
Appendix 7 Preparing Connecting Cables for Bar Code Readers	A-43
Appendix 8 Standard Models	A-44
Appendix 9 List of Optional Products	A-61
A-9-1 Anti-reflection Sheets: NS15-KBA04, NS12-KBA04, NS7-KBA04, NT30-KBA04	A-61
A-9-2 Protective Covers: NS15-KBA05N, NS12-KBA05(N), NS7-KBA05(N), NT31C-KBA05(N)	A-62
A-9-3 NT30-KBA01 Chemical-resistant Cover	A-63
A-9-4 Replacement Battery: CJ1W-BAT01	A-63
A-9-5 Recommended Memory Cards.....	A-64
A-9-6 NS-CLK21 Controller Link Interface Unit	A-64
A-9-7 NS-CA001/CA002 Video Input Unit.....	A-64
A-9-8 Attachments: NS12-ATT01(B)/NS12-ATT02/NS8-ATT01/ NS8-ATT02	A-64
A-9-9 NS-USBEXT-1M USB Relay Cable.....	A-65
Appendix 10 System Memory List	A-66
Appendix 11 Differences between "-V1"/"-V2" Models and Other Models	A-69
Appendix 12 NS5 System Menu.....	A-71

About this Manual

Section 1 Overview

This section provides an overview of the NS-series PTs, including functions, features, connection types, and communications methods.

Section 2 Before Connecting

This section provides information on methods for connecting NS-series PTs that must be understood before connecting the host and peripheral devices.

Section 3 Installing the PT and Connecting Peripheral Devices

This section describes the methods used to install the PT and connect peripheral devices.

Section 4 Connecting Host to Serial Port

This section describes the methods for connecting the host to the serial port of the PT.

Section 5 Connecting to Host via Ethernet or Controller Link

This section describes the methods for connecting the PT to the host using the PT's Ethernet interface and the Controller Link Interface Unit.

Section 6 System Menu Operations

This section describes the methods for operating the System Menu. It also provides details on functions that are useful for NS-series PT applications and for system maintenance.

Section 7 Maintenance and Troubleshooting

This section describes the maintenance and inspection methods for preventing errors occurring, and troubleshooting measures when errors occur in the PT.

Appendices

Describe hardware specifications and methods for preparing connections cables, and provide lists of standard products.



WARNING

Failure to read and understand the information provided in this manual may result in personal injury or death, damage to the product, or product failure. Please read each section in its entirety and be sure you understand the information provided in the section and related sections before attempting any of the procedures or operations given.

Related Manuals

The following manuals are used for NS-series PTs. (The boxes at the end of the catalog numbers indicate the revision code.)

**This
manual**

NS Series -V1/-V2 Setup Manual V083-E1-□

Provides information on NS Series V1 and V2 PTs (i.e., NS15-V2, NS12-V□, NS10-V□, NS8-V□, and NS5-V□).

Describes how to connect the PT to the host and peripheral devices, methods to setup communications and operation, and procedures for maintenance.

Refer to the *NS Series Programming Manual* (V073-E1-□) for information on PT functions and specific operating procedures.

NS Series Setup Manual..... V072-E1-□

Provides information on NS Series PTs prior to V1 (i.e., NS12, NS10, and NS7).

Describes how to connect the PT to the host and peripheral devices, methods to setup communications and operation, and procedures for maintenance.

Refer to the *NS Series Programming Manual* (V073-E1-□) for information on PT functions and specific operating procedures.

NS Series Programming Manual V073-E1-□

Describes the screen configurations, object functions, and host communications for the PT.

CX-Designer User's Manual V099-E1-□

The screens displayed on the PT can be created in the CX-Designer and transferred between the CX-Designer and PT. This manual describes the installation and features of the CX-Designer. For details on CX-Designer operations, refer to the CX-Designer's Online Help.

Terminology

The following terminology is used in this manual.

PT	In this manual, indicates an NS-series Programmable Terminal.
NS Series	Indicates products in the OMRON NS□□ Series of Programmable Terminals.
PLC	Indicates a Programmable Controller in the OMRON SYSMAC CS/CJ, C, or CVM1/CV Series of Programmable Controllers.
NJ/NX Series	Indicates a Controller in the OMRON SYSMAC NJ Series of Controllers: NJ101, NJ301, NJ501, NX701, NX102, or NX1P2.
CS/CJ Series	Indicates Programmable Controllers in the OMRON SYSMAC CS/CJ Series of Programmable Controllers: CS1G, CS1H, CS1G-H, CS1H-H, CJ1G, CJ1G-H, CJ1H-H, CJ1M, CP1H, CP1L, CP1E, CP2E, CJ2H, CJ2M. In this manual, "CJ1H-H" indicates the CJ1H-CPU□□H-R and CJ1H-CPU□□H CPU Units. "CJ1H-H-R" is used to indicate only the CJ1H-CPU □□H-R CPU Units. The "CP Series" is used to indicate the CP1H, CP1L, CP1E, and CP2E.
C Series	Indicates products in the OMRON SYSMAC C Series of Programmable Controllers: C200HS, C200HX(-Z), C200HG(-Z), C200HE(-Z), CQM1, CQM1H, CPM1A, CPM2A, CPM2C.
CVM1/CV Series	Indicates products in the OMRON SYSMAC CVM1/ CV Series of Programmable Controllers: CV500, CV1000, CV2000, CVM1
Serial Communications Unit	Indicates a Serial Communications Unit for an OMRON CS/CJ-series PLC.
Serial Communications Board	Indicates a Serial Communications Board for an OMRON CS-series or CQM1H PLC.
Communications Board	Indicates a Communications Board for an OMRON C200HX/HG/HE(-Z) PLC.
CPU Unit	Indicates a CPU Unit in the OMRON SYSMAC CS/CJ, NJ/NX, C, or CVM1/CV Series of Programmable Controllers.
CX-Designer	Indicates the OMRON CX-Designer.
Host	Indicates the PLC, IBM PC/AT or compatible computer, or personal computer functioning as the control device and interfaced with the NS-series PT.
Programming Manual	Indicates the <i>NS Series Programming Manual</i> (V073-E1-□).

Introduction

• Intended Audience

This manual is intended for the following personnel, who must also have knowledge of electrical systems (an electrical engineer or the equivalent).

- Personnel in charge of introducing FA systems into production facilities.
- Personnel in charge of designing FA systems.
- Personnel in charge of installing and connecting FA systems.
- Personnel in charge of managing FA systems and facilities.

• General Precautions

- The user must operate the product according to the performance specifications described in the operation manuals.
- Do not use the PT touch switch input functions for applications where danger to human life or serious property damage is possible, or for emergency switch applications.
- Before using the product under conditions which are not described in the manual or applying the product to nuclear control systems, railroad systems, aviation systems, vehicles, combustion systems, medical equipment, amusement machines, safety equipment, and other systems, machines and equipment that may have a serious influence on lives and property if used improperly, consult your OMRON representative.
- Make sure that the ratings and performance characteristics of the product are sufficient for the systems, machines, and equipment, and be sure to provide the systems, machines, and equipment with double safety mechanisms.
- This manual provides information for connecting and setting up an NS-series PT. Be sure to read this manual before attempting to use the PT and keep this manual close at hand for reference during installation and operation.

Safety Precautions

Notation Used for Safety Information

The following notation is used in this manual to provide precautions required to ensure safe usage of the product.



The safety precautions that are provided are extremely important to safety.







Always read and heed the information provided in all safety precautions.

The following notation is used.

 WARNING	<p>Indicates a potentially hazardous situation which, if not avoided, will result in minor or moderate injury, or may result in serious injury or death. Additionally there may be significant property damage.</p>
--	---

Symbols

	<p>Prohibition Indicates a general prohibition</p>
	<p>Caution Indicates general cautionary, warning, or danger level information</p>

 WARNING	
<p>Always ensure that the personnel in charge confirm that installation, inspection, and maintenance were properly performed for the PT. "Personnel in charge" refers to individuals qualified and responsible for ensuring safety during machine design, installation, operation, maintenance, and disposal.</p>	
<p>Ensure that installation and post-installation checks are performed by personnel in charge who possess a thorough understanding of the machinery to be installed.</p>	
<p>Do not use the input functions of the PT, such as the function switches or switches on the touch panel, in applications that involve human life, in applications that may result in serious injury, or for emergency stop switches.</p>	
<p>Do not attempt to disassemble, repair, or modify the PT. Doing so may impair the safety functions.</p>	
<p>Do not attempt to take the Unit apart and do not touch any internal parts while the power is being supplied. Doing either of these may result in electrical shock.</p>	
<p>Never press more than two points on the touch panel of the NS15-TX01□-V2 at the same time. An analog touch panel is used. If two points are pressed at the same time, it may activate a switch somewhere midway between the two points.</p>	

Precautions for Safe Use

1. When unpacking the Units, check carefully for any external scratches or other damage. Also, shake the Units gently and check for any abnormal sound.
2. The PT must be installed in a control panel.
3. The mounting panel must be between 1.6 and 4.8 mm thick. Tighten the Mounting Brackets evenly to a torque of between 0.5 and 0.6 N·m to maintain water and dust resistance. Make sure the panel is not dirty or warped and that it is strong enough to hold the Units.
4. Do not let metal particles enter the Units when preparing the panel.
5. Do not connect an AC power supply to the DC power input terminals.
6. Use a DC power supply with minimal voltage fluctuation that provides a stable output even if the power supply input is interrupted for 10 ms. The DC power supply must also have reinforced or double insulation.
Rated power supply voltage: 24 VDC (Allowable range: 20.4 to 27.6 VDC)
Capacity: NS15: 45 W min.
 NS12, NS10, or NS8: 25 W min.
 NS5: 15 W min.
7. Do not perform a dielectric voltage test.
8. Use a twisted-pair cable with a AWG14 to 20 to connect to the power terminals and always use M3.5 crimp terminals. Tighten the terminal screws to a torque of 0.8 N·m. Make sure the screws are properly tightened.
9. Ground the Unit correctly to prevent operational errors caused by noise.
10. Do not touch the surface of the circuit board or the components mounted on it with your bare hands. Discharge any static electricity from your body before handling the board.
11. Confirm that the current capacity of the connected device is 250 mA or less before using the 5-V power supply from pin 6 of the RS-232C connector. The 5-V output from the PT is 250 mA max. at 5 V \pm 5%.
12. Turn OFF the power supply before connecting or disconnecting cables.
13. Always tighten the connector screws after connecting communications cables.
14. Do not pull on the cables or bend the cables beyond their natural limit.
Do not place heavy objects on top of the cables or other wiring lines. Doing so may break the cables.
15. Confirm the safety of the system before turning ON or OFF the power supply or before pressing the reset button.
16. The whole system may stop depending on how the power supply is turned ON or OFF. Turn ON or OFF the power supply according to the specified procedure.
17. After changing the settings of the DIP switch, always turn the power supply OFF and ON or reset the PT.
18. Do not perform the following operations while the Memory Card is being accessed:
 - Turning OFF the power supply to the PT
 - Pressing the PT's reset switch
 - Removing the Memory Card
19. To ensure system safety, incorporate a program that periodically calls PT operation bits from the host side to check that the PT is properly operating.
20. Start actual system application only after sufficiently checking screen data, macros, and the operation of the program in the host.
21. Do not press a touch switch with a force greater than 30 N.
22. Do not operate a touch switch using a screwdriver or other tool.
23. Confirm the safety of the system before pressing a touch switch.
24. Do not press touch switches consecutively without pausing in between. If touch switches are pressed consecutively at high speed, the PT may not be able to detect the inputs. Confirm that the PT has detected the input of a touch switch before pressing any other touch switch.
25. Do not accidentally press touch switches when the backlight is not lit or when the display does not appear. Confirm the safety of the system before pressing touch switches.

26. To ensure safety when using numeral input functions, set the upper and lower limits for the input value.
27. Before initializing screen data, confirm that existing data is backed up at the CX-Designer.
28. When changing the password with the system menu, do not reset or turn OFF the power supply until writing is finished. If the password is not saved successfully, the screen may not operate.
29. When using the device monitor, confirm the safety of the system before performing the following operations.
 - Changing monitor data
 - Changing operation modes
 - Forced setting or resetting
 - Changing present values or set values
30. Dispose of any battery that has been dropped on the floor or otherwise subjected to excessive shock.
31. Do not connect an USB connector to any device that is not applicable.
32. Before connecting an USB connector to a device, make sure that the device is free of damage.
33. Commercially available USB hubs and the recommended USB hub do not necessarily have the same general specifications as the PT, and may not function properly if used in environments subject to static electricity or other forms of noise. When using a USB hub, take sufficient measures to prevent static electricity and other forms of noise, or do not install the PT in an environment subject to such noise.
34. Do not perform the following operations while downloading or uploading screen data or system program. Doing so may corrupt the screen data or system program.
 - Turning OFF the power supply to the PT
 - Pressing the PT's reset switch
35. When mounting the Battery, be sure to use the correct Battery and mount it correctly.
36. Do not disassemble or short-circuit the battery.
37. Dispose of the Units and batteries according to local ordinances as they apply.



廢電池請回收

38. Never use volatile solvents, such as benzene or thinners, or chemical dusters to clean the PT.
39. Mercury is used in the backlights of all PTs except for the following PTs: NS5-SQ1/-TQ1 PTs with lot number 15Z0 or later, NS8 PTs with lot number 28X1 or later, NS10 PTs with lot number 11Y1 or later, NS12 PTs with lot number 14Z1 or later, and NS15 PTs with lot number 31114 or later. Do not dispose of the PT together with waste to be processed at disposal plants. Dispose of the PT according to all local laws, regulations, and ordinances.
40. The backlight in the PT cannot be replaced by the user. Contact your OMRON representative for backlight replacement.
41. Periodically check the installation conditions in applications where the PT is subject to contact with oil or water.
42. The NS15-TX01□-V2 uses an analog touch panel. Deterioration over time can cause the touch points to move. If the touch points move too far, calibrate the touch panel.
43. Never connect two or more crimp terminals to one terminal.
44. Water and oil resistance will be lost if the front sheet is torn or is peeling off. Do not use the PT if the front sheet is torn or is peeling off.
45. The Rubber Packing will deteriorate, shrink, expand, or harden depending on the operating environment. Inspect and replace the Rubber Packing periodically.

Precautions for Correct Use

1. Do not install the Unit in the following places:
 - Locations subject to severe changes in temperature.
 - Locations subject to direct sunlight
 - Locations subject to temperatures or humidity outside the range specified in the specifications
 - Locations subject to condensation as the result of high humidity
 - Locations subject to corrosive or flammable gases
 - Locations subject to shock or vibration
 - Outdoor locations directly subject to wind or rain
 - Locations subject to strong ultraviolet light
 - Locations subject to excessive dust
 - Locations subject to direct sunlight
2. Take appropriate and sufficient countermeasures when installing systems in the following locations:
 - Locations subject to static electricity or other forms of noise
 - Locations subject to strong electromagnetic fields
 - Locations close to power supplies
 - Locations subject to possible exposure to radioactivity

Conformance to EC Directives

This product is EMC compliant.

• Concepts

OMRON products are electronic devices that are incorporated in machines and manufacturing installations. OMRON PTs conform to the related EMC Directives (see note) so that the devices and machines into which they are built can more easily conform to EMC directives. However, customers may use a wide variety of equipment and manufacturing installations. Therefore the customer must check whether the Directives are satisfied for the actual system. EMC-related performance will vary depending on the configuration, wiring, and other conditions of the equipment or control panel in which the PT is installed. The customer must, therefore, perform final checks to confirm that the overall machine or device conforms to EMC standards.

Note: Applicable EMC (Electromagnetic Compatibility) standards are as follows:
EMS (Electromagnetic Susceptibility): EN 61131-2
EMI (Electromagnetic Interference): EN 61131-2
(EN 61131-2 radiated emission: 10-m regulations)

• Conformance to EC Directives

NS-series PTs conform to EC Directives. To ensure that the machine or device in which the NS-series PT is used complies with EC Directives, the PT must be installed as follows:

- The NS-series PT must be installed in a control panel.
- You must use reinforced insulation or double insulation for the DC power supply and the DC power supply must have minimal voltage fluctuations and provide a stable output even if the power supply input is interrupted for 10 ms.
- NS-series PTs complying with EC Directives also conform to the Common Emission Standard (EN 61131-2). Radiated emission characteristics (10-m regulations) may vary depending on the configuration of the control panel used, other devices connected to the control panel, wiring, and other conditions. You must therefore confirm that the overall machine or equipment complies with EC Directives.
- This is a class A product. It may cause radio interference in residential areas, in which case the user may be required to take adequate measures to reduce interference.

Conformance to Shipbuilding Standards

This product complies with shipping standards. Application conditions are set for compliance for individual shipping standards, and it may not be possible to use the product in some installation locations. Contact an OMRON sales representative before using the product.

• International Shipping Standards

Shipping Standards of Various Countries

Abbreviation	Country	Name
NK	Japanese	Nippon Kaiji Kyokai
LR	Great Britain	Lloyd's Register of Shipping
DNV	Norway	Det Norske Veritas
RINA	Italy	Registro Italiano Navale
BV	France	Bureau Veritas
GL	Germany	Germanischer Lloyd
ABS	USA	American Bureau of Shipping
KR	South Korea	Korean Register of Shipping
CR	Taiwan	China Corporation Register of Shipping

• Certification Status for NS-series Programmable Terminals

The following table shows the compliance status with shipping standards for NS-series Programmable Terminals as of April 2009.

Abbreviation	NS5	NS8	NS10	NS12	NS15
NK	Yes	Yes	Yes	Yes	Yes
LR	Yes	Yes	Yes	Yes	Yes
DNV	Yes	Yes	Yes	Yes	Yes
RINA	No	No	No	No	No
BV	Yes	Yes	Yes	Yes	No
GL (See note.)	Conditional	Conditional	Conditional	Conditional	No
ABS	Yes	Yes	Yes	Yes	No
KR	Yes	Yes	Yes	Yes	No
CR	No	No	No	No	No

Note: GL certification has been received only for the NS**-V1.

• Certification Zones for Shipping Standards

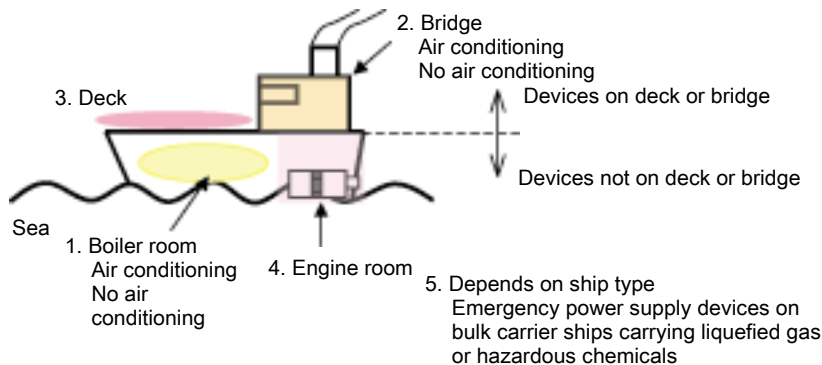

1. Zones with and without air conditioning not on the bridge or deck (e.g., boiler room)
2. Zones with and without air conditioning on the bridge (e.g., helm room)
3. Deck zone
4. Engine room zone (devices mounted on machinery that has strict vibration conditions, such as diesel engines or air compressors)
5. Depends on the ship type. Emergency power supply devices on bulk carrier ships carrying liquefied gas or hazardous chemicals.

• Certification Zones for Shipping Standards

Standard	1. Not on deck or bridge		2. Bridge		3. Deck	4. Engine (e.g.)	5. Ship type (e.g., bulk ship with liquefied gas)
	No air conditioning	Air conditioning	No air conditioning	Air conditioning			
NK	No	Yes	No	Yes	No	No	No
LR	No	Yes	No	Yes	No	No	No
DNV	No	Yes	No	Yes	No	No	No
RINA	No	No	No	No	No	No	No
BV	No	Yes	No	No	No	No	No
GL	No	Yes	No	No	No	No	No
ABS	No	Yes	No	No	No	No	No
KR	No	Yes	No	No	No	No	No
CR	No	No	No	No	No	No	No

• Precautions for Compliance with Shipping Standards

1. Always install the NS-series PT in a control panel.
2. Install the NS-series PT in a control panel that has air conditioning.
3. Cover the entire surface of the NS-series PT with electromagnetic shielding material and ground the control panel or operation panel with copper tape or other conductive tape.
4. Completely shield the gap at openings in the control panel or operation panel with a gasket.
5. Completely shield the gap between the NS-series PT and the panel cutout with copper tape or other conductive tape before securing the NS-series PT with the mounting bracket.
6. Connect a noise filter to the power supply line connected between the 24-VDC and 0-VDC terminals.

Electromagnetic Shielding

Manufacturer	Zippertubing (Japan), Ltd.
Model	SWF132075

Note: The transmission rate of the liquid crystal display will decrease by approximately 50% when the electromagnetic shielding is mounted.

Noise Filter

Manufacturer	Cosel Co. Ltd.
Model	TAH-06-683

Terms and Conditions Agreement

Warranty, Limitations of Liability

Warranties

Exclusive Warranty

Omron's exclusive warranty is that the Products will be free from defects in materials and workmanship for a period of twelve months from the date of sale by Omron (or such other period expressed in writing by Omron). Omron disclaims all other warranties, express or implied.

Limitations

OMRON MAKES NO WARRANTY OR REPRESENTATION, EXPRESS OR IMPLIED, ABOUT NON-INFRINGEMENT, MERCHANTABILITY OR FITNESS FOR A PARTICULAR PURPOSE OF THE PRODUCTS. BUYER ACKNOWLEDGES THAT IT ALONE HAS DETERMINED THAT THE PRODUCTS WILL SUITABLY MEET THE REQUIREMENTS OF THEIR INTENDED USE.

Omron further disclaims all warranties and responsibility of any type for claims or expenses based on infringement by the Products or otherwise of any intellectual property right.

Buyer Remedy

Omron's sole obligation hereunder shall be, at Omron's election, to (i) replace (in the form originally shipped with Buyer responsible for labor charges for removal or replacement thereof) the non-complying Product, (ii) repair the non-complying Product, or (iii) repay or credit Buyer an amount equal to the purchase price of the non-complying Product; provided that in no event shall Omron be responsible for warranty, repair, indemnity or any other claims or expenses regarding the Products unless Omron's analysis confirms that the Products were properly handled, stored, installed and maintained and not subject to contamination, abuse, misuse or inappropriate modification. Return of any Products by Buyer must be approved in writing by Omron before shipment. Omron Companies shall not be liable for the suitability or unsuitability or the results from the use of Products in combination with any electrical or electronic components, circuits, system assemblies or any other materials or substances or environments. Any advice, recommendations or information given orally or in writing, are not to be construed as an amendment or addition to the above warranty.

See <http://www.omron.com/global/> or contact your Omron representative for published information.

Limitation on Liability; Etc

OMRON COMPANIES SHALL NOT BE LIABLE FOR SPECIAL, INDIRECT, INCIDENTAL, OR CONSEQUENTIAL DAMAGES, LOSS OF PROFITS OR PRODUCTION OR COMMERCIAL LOSS IN ANY WAY CONNECTED WITH THE PRODUCTS, WHETHER SUCH CLAIM IS BASED IN CONTRACT, WARRANTY, NEGLIGENCE OR STRICT LIABILITY.

Further, in no event shall liability of Omron Companies exceed the individual price of the Product on which liability is asserted.

Application Considerations

Suitability of Use

Omron Companies shall not be responsible for conformity with any standards, codes or regulations which apply to the combination of the Product in the Buyer's application or use of the Product. At Buyer's request, Omron will provide applicable third party certification documents identifying ratings and limitations of use which apply to the Product. This information by itself is not sufficient for a complete determination of the suitability of the Product in combination with the end product, machine, system, or other application or use. Buyer shall be solely responsible for determining appropriateness of the particular Product with respect to Buyer's application, product or system. Buyer shall take application responsibility in all cases.

NEVER USE THE PRODUCT FOR AN APPLICATION INVOLVING SERIOUS RISK TO LIFE OR PROPERTY OR IN LARGE QUANTITIES WITHOUT ENSURING THAT THE SYSTEM AS A WHOLE HAS BEEN DESIGNED TO ADDRESS THE RISKS, AND THAT THE OMRON PRODUCT(S) IS PROPERLY RATED AND INSTALLED FOR THE INTENDED USE WITHIN THE OVERALL EQUIPMENT OR SYSTEM.

Programmable Products

Omron Companies shall not be responsible for the user's programming of a programmable Product, or any consequence thereof.

Disclaimers

Performance Data

Data presented in Omron Company websites, catalogs and other materials is provided as a guide for the user in determining suitability and does not constitute a warranty. It may represent the result of Omron's test conditions, and the user must correlate it to actual application requirements. Actual performance is subject to the Omron's Warranty and Limitations of Liability.

Change in Specifications

Product specifications and accessories may be changed at any time based on improvements and other reasons. It is our practice to change part numbers when published ratings or features are changed, or when significant construction changes are made. However, some specifications of the Product may be changed without any notice. When in doubt, special part numbers may be assigned to fix or establish key specifications for your application. Please consult with your Omron's representative at any time to confirm actual specifications of purchased Product.

Errors and Omissions

Information presented by Omron Companies has been checked and is believed to be accurate; however, no responsibility is assumed for clerical, typographical or proofreading errors or omissions.

Section 1

Overview

This section provides an overview of the NS-series PTs, including functions, features, connection types, and communications methods.

1-1	NS-series PT Functions and Operation	1-2
1-1-1	PT Functions for FA Manufacturing Sites	1-2
1-1-2	NS-series PT Operating System	1-3
1-2	Communications with the Host	1-5
1-2-1	What is an NT Link?	1-6
1-2-2	Ethernet	1-6
1-2-3	Controller Link	1-6
1-2-4	Host Link	1-6
1-2-5	Connecting to a Temperature Controller	1-6
1-2-6	Memory Link Connections	1-7
1-2-7	Communicating with Other Devices	1-7
1-2-8	EtherNet/IP	1-7
1-3	System Configuration	1-8
1-3-1	Supported Peripheral Devices	1-8
1-4	Procedure for Running NS-series PTs	1-10

1-1 NS-series PT Functions and Operation

The NS Series offers advanced operator interfaces called Programmable Terminals that can be used to display required information and provide operating capabilities for FA manufacturing sites. This section describes the role and functions of the NS-series PTs for first-time users of Programmable Terminals.

1-1-1 PT Functions for FA Manufacturing Sites

● Line Operating Status Monitor Display

NS-series PTs can be used to display information such as the operating status of the system and the devices. Graphs and other indicators can be used to better represent the information and make it easy to understand.

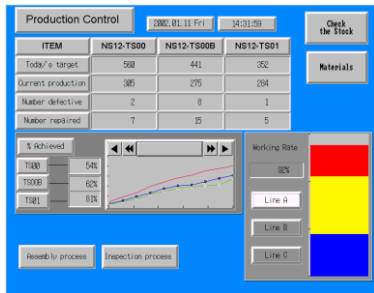

● Directions for FA Site Operators

The PTs can be used to inform the operators of system and device errors and assist them in taking appropriate measures.

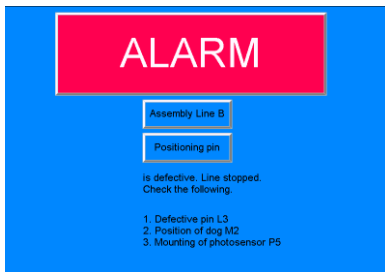

● **Control Panel Switches**

The NS-series PTs allow the user to create various on-screen switches. By using touch switch inputs, operating results can be sent to the host.

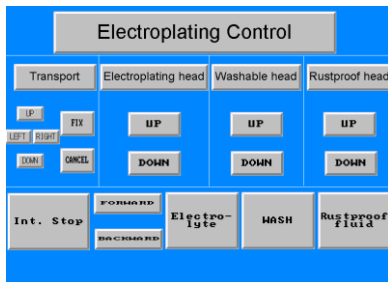

1-1-2 **NS-series PT Operating System**

● **Transferring Screen Data**

The screen data displayed on NS-series PTs is created using the CX-Designer on a computer and transferred to the PT through RS-232C, Ethernet, or USB communications.

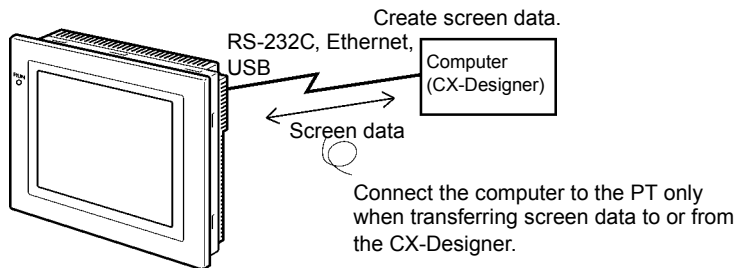

Note 1: Some models do not support Ethernet.

Note 2: USB data transfer is not supported for some PT lots and system program versions.

Note 3: If the serial port protocol is set to *Allen-Bradley DF1*, you cannot connect to the CX-Designer through that port.

Screen data can also be transferred at high speed using a Memory Card.

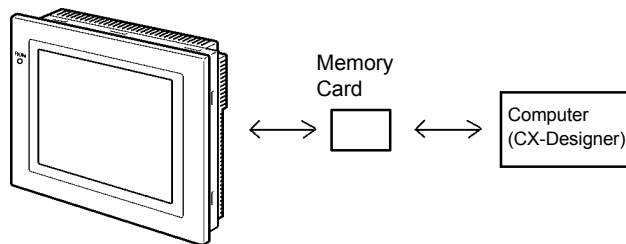

● Displaying Screens

The information displayed on the screens is created using the CX-Designer on a computer and transferred to the PT. The required screens can be displayed by using commands from the host or touch switch operations.

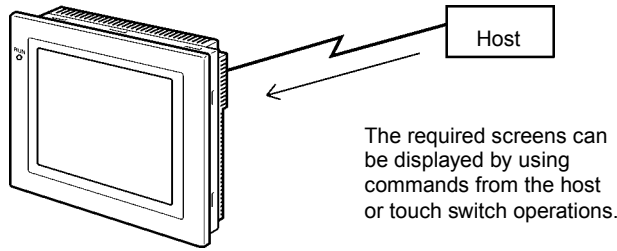

● Reading Data from the Host

A communications method such as NT Link Ethernet or Controller Link is used to connect the host, and the required data is automatically read from the host.

Note: Some models do not support Ethernet or Controller Link.

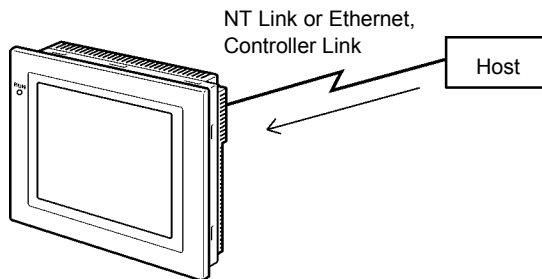

● Sending Data to the Host

Data input using touch switches (button ON/OFF status, numerals, and character strings) is sent to the host.

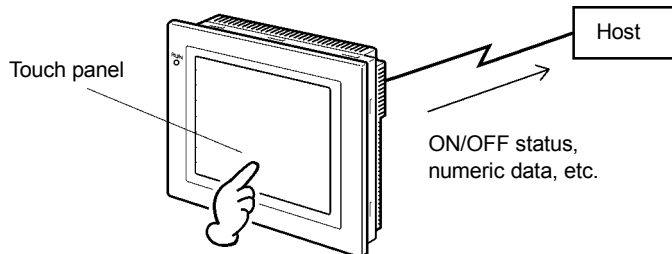

1-2 Communications with the Host

NS-series PTs allow the user to allocate words and bits in any PLC area for use in accessing the required display contents and storing input data.

Operations that can be performed include reading and writing allocated word contents and bit status directly, changing the display status of functional objects on the PT screen, and controlling and notifying PT status.

The NS-series PTs also enable communications with more than one PLC. A host name is registered for each PLC connected, allowing access to any PLC areas by specifying the host name and address.

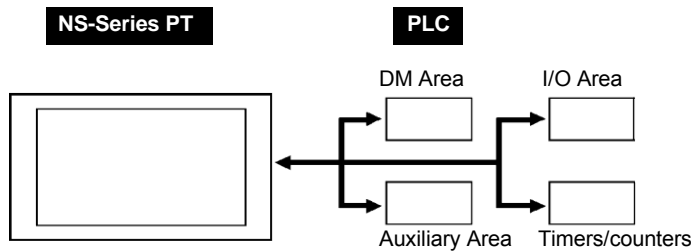

When using NS-series PTs, the host can be connected using any of the following methods.

- 1:1 NT Link
- 1:N NT Link (normal or high-speed)
- Ethernet
- Controller Link
- Host Link
- Other methods, such as temperature controller protocols
- EtherNet/IP

1-2-1 What is an NT Link?

An NT Link is a method for high-speed communications between an OMRON PLC and an OMRON Programmable Terminal (PT) using a special protocol. In addition to a 1:1 NT Link, where a single PT is connected to a single PLC, NS-series PTs also support 1:N NT Links, allowing up to eight PTs to be connected to a single PLC port.

CS- and CJ-series PLCs can also be connected using high-speed 1:N NT Link communications. For details on the PLCs that support high-speed 1:N NT Link communications, refer to *Appendix 8 Standard Models*.

In the rest of this manual, "NT Link" refers to NT Link communications in general, "1:1 NT Link" refers to an NT Link in a 1:1 configuration only, and "1:N NT Links" refers to NT Links in a 1:N configuration only. Where necessary, "normal 1:N NT Links" and "high-speed 1:N NT Links" are used. When "1:N NT Links" is used alone, it refers to both normal and high-speed communications.

1-2-2 Ethernet

Ethernet Units in PLCs that are supported by the NS-series PTs can be used to read and write data, word, and bit information simply. The use of FINS (Factory Interface Network Service) message communications, one of OMRON's standard communications services, enables high-speed communications without the need to be aware of the protocol.

For details on connection methods, refer to *Section 5 Connecting to Host via Ethernet or Controller Link*. For details on the PLCs that can be connected to the Ethernet, refer to *Appendix 8 Standard Models*.

1-2-3 Controller Link

Controller Link is an FA network that can send and receive large data packets among OMRON PLCs and FA computers. Controller Link Units for PLCs that are supported by the NS-series PTs connected to NS-CLK21 Controller Link Interface Units can be used to read and write data, word, and bit information simply.

The Controller Link supports data links that enable data sharing and a message service that enables sending and receiving data when required.

For details on connection methods, refer to *Section 5 Connecting to Host via Ethernet or Controller Link*. For details on the PLCs that can be connected using Controller Link, refer to *Appendix 8 Standard Models*.

Note: Controller Link Interface Units are compatible only with the NS15, NS12, and NS10.

1-2-4 Host Link

Host Link is a serial communications protocol for connecting an OMRON PT 1:1 to a host (a PLC) to read and write bits and words from the host. Host Link communications connect a PT to many different PLCs. Refer to the *Host Connection Manual (Host Links)* for connection methods and the PLCs for which Host Links can be used.

1-2-5 Connecting to a Temperature Controller

OMRON Temperature Controllers can be connected with an RS-485 connection.

Attach a CJ1W-CIF11 RS-422A Converter to serial port A or B to convert the communications protocol to RS-485. For details, refer to the *Host Connection Manual (Temp. Control, MemLink)*.

1-2-6 Memory Link Connections

When the host is a computer instead of a PLC, the Memory Link protocol can be used to connect with the computer. Use serial port A or B to connect to the host. For details, refer to the *Host Connection Manual (Tem.Control, MemLink)*.

1-2-7 Communicating with Other Devices

The NS-series PTs can communicate with the following devices.

- OMRON Trajexia Motion Controllers
- Mitsubishi FX-series, A-series, and Q-series PLCs
- Siemens S7-300-series PLCs
- Yaskawa MP-series Machine Controllers
- Yaskawa F7-series Varispeed and VS Mini V7-series Inverters
- Rockwell Automation (Allen-Bradley) SLC500, MicroLogix, PLC-5, CompactLogix, CompactLogix, and ControlLogix Controllers
- Devices that support Modbus RTU
- Yokogawa Electric FA-M3/FA-M3R-series PLCs

For details on connection methods, refer to the *Host Connection Manual (Multivendor Connection)*.

1-2-8 EtherNet/IP

EtherNet/IP is a multi-vendor industrial network protocol that uses Ethernet. The specification is an open standard managed by the ODVA (Open DeviceNet Vendor Association), as is DeviceNet, and it is used for a variety of industrial devices.

NS-series PTs can communicate with CS/CJ-series EtherNet/IP Units and CJ2H-CPU□□-EIP, CJ2M-CPU3□, NJ□01-□□□□, NX□0□-□□□□, or NX1P2-□□□□ Units with built-in EtherNet/IP ports.

Also, it is possible to perform tag message communications when using a CPU Unit with a built-in EtherNet/IP port. These CPU Units contain a tag name server, so if tag names and an address table are stored in advance in the CPU Unit, it is possible to perform access from the NS-series PT using only the tag names.

1-3 System Configuration

The following information describes the system configuration using NS-series PTs. Refer to *Appendix 8 Standard Models* for details on available models.

1-3-1 Supported Peripheral Devices

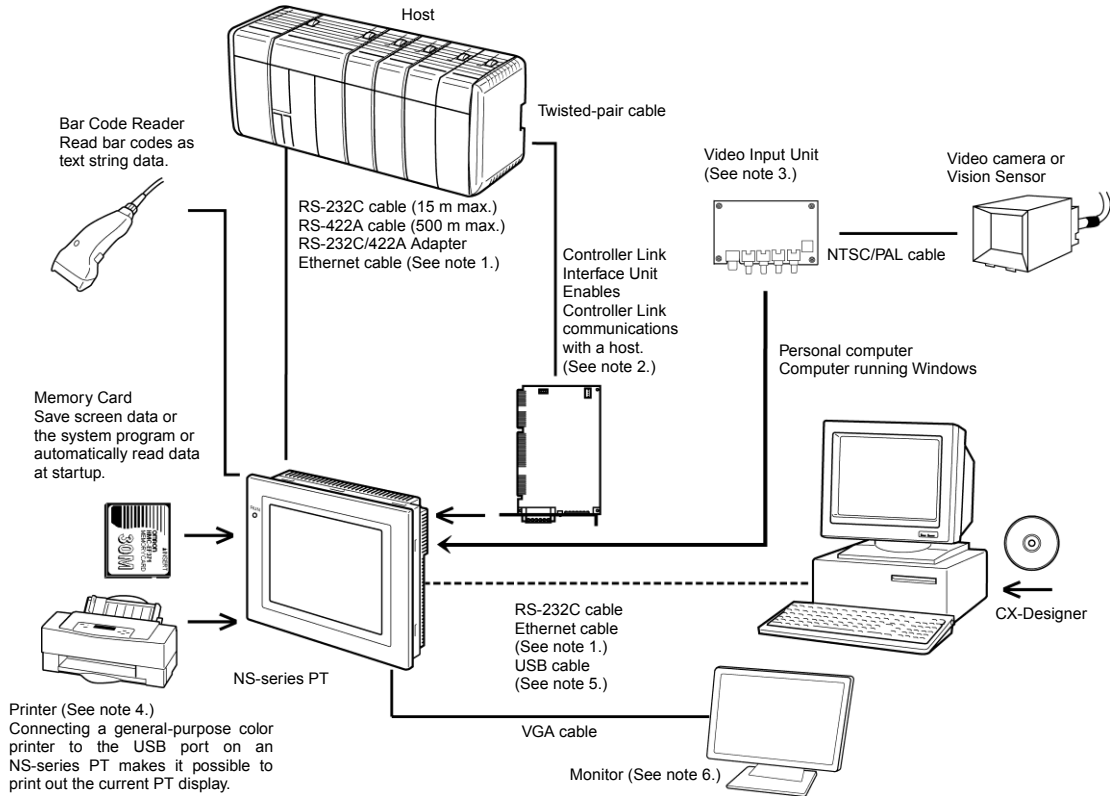

Note 1: Only the following models support Ethernet: NS15-TX01□-V2, NS12-TS01(B)-V□, NS10-TV01(B)-V□, NS8-TV□1(B)-V□, NS5-SQ□1(B)-V□, NS5-TQ□1(B)-V□, and VS5-MQ□1(B)-V□.

Note 2: Only the following models support the Controller Link Interface Unit: NS15-TX01□-V2, NS12-TS0□, NS10-TV0□. (The NS8 and NS5 do not support the Controller Link Interface Unit.)

Note 3: The following models support Video Input Units: NS15-TX01□-V2, NS12-TS0□, NS10-TV0□, and NS8-TV□□. (The NS15-TX01-V2 does not support the NS-CA001 and it does not support video input from the NS-CA002. It does support analog RGB input from the NS-CA002.) (The NS5 does not support Video Input Units.)

Note 4: The NS5-SQ0□(B)-V□, NS5-TQ0□(B)-V□, and NS5-MQ0□(B)-V□ cannot be connected directly to general-purpose printers.

Note 5: Refer to 3-3-2 *Connecting via USB* for information on connecting the PT and computer with a USB cable.

A USB Relay Cable can be used to place a USB slave connector on the front of the control panel. Refer to 3-1-3 *Mounting the PT to the Control Panel*.

Note 6: Only the following monitor is supported: NS15-TX01□-V2.

- **PTs (Refer to *Appendix 8 Standard Models*.)**

- **NS-series PT Accessories: Mounting Brackets**

Model	Quantity
NS15	16
NS12/NS10	14
NS8	4
NS5	6

- **Recommended Bar Code Reader (Refer to page 3-15.)**

OMRON V520-RH21-6
OMRON V400-H111
OMRON V400-H211

- **RS-232C/422A Converters**

OMRON NS-AL002 (non-insulated) (Refer to *Appendix 3 Using NS-AL002 Converters.*)
OMRON NT-AL001 (insulated) (Refer to *Appendix 4 Using NT-AL001 Converters.*)
OMRON CJ1W-CIF11

- **Recommended Memory Cards (Refer to 3-6 Using Memory Cards.)**

Model	Memory capacity	Memory type
HMC-EF183	128 MB	Flash memory
HMC-EF283	256 MB	Flash memory
HMC-EF583	512 MB	Flash memory

- **CX-Designer (Refer to the *CX-Designer Online Help.*)**

NS-CXDC1-V□ (CD-ROM version)

- **Video Input Unit (Refer to 3-7 Installing the Video Input Unit.)**

NS-CA001
NS-CA002: Refer to the *NS Series RGB and Video Input Unit Operation Manual* (Cat. No. V086).

- **Controller Link Interface Unit (Refer to 3-8 Installing the Controller Link Interface Unit.)**

NS-CLK21

- **USB-compatible Printers (Refer to 3-5 Connecting to Printers.)**

- **Attachments (Refer to A-9-8 Attachments: NS12-ATT01(B)/NS12-ATT02/NS8-ATT01/NS8-ATT02.)**

Use an Attachment when replacing NT-series PTs.

NS12-ATT01(B)
NS12-ATT02
NS8-ATT01
NS8-ATT02

- **USB Relay Cable (Refer to 3-1-3 Mounting the PT to the Control Panel.)**

NS-USBEXT-1M

Reference The following optional products are available. (Refer to *Appendix 9 List of Optional Products.*)

Anti-reflection Sheets (5 sheets)	NS15-KBA04 NS12-KBA04 NS7-KBA04 NT30-KBA04	(For NS15) (For NS12 and NS10) (For NS8) (For NS5)
Protective Covers (anti-reflection coating) (5 covers)	NS12-KBA05 NS7-KBA05 NT31C-KBA05	(For NS12 and NS10) (For NS8) (For NS5)
Transparent Protective Covers (5 covers)	NS12-KBA05N NS7-KBA05N NT31C-KBA05N	(For NS12 and NS10) (For NS8) (For NS5)
Chemical-resistant Cover (1 cover)	NT30-KBA01	(For NS5)
Replacement Battery	CJ1W-BAT01	(For NS15, NS12, NS10, NS8 and NS5)

1-4 Procedure for Running NS-series PTs

Use the following procedure to start up the NS-series system.

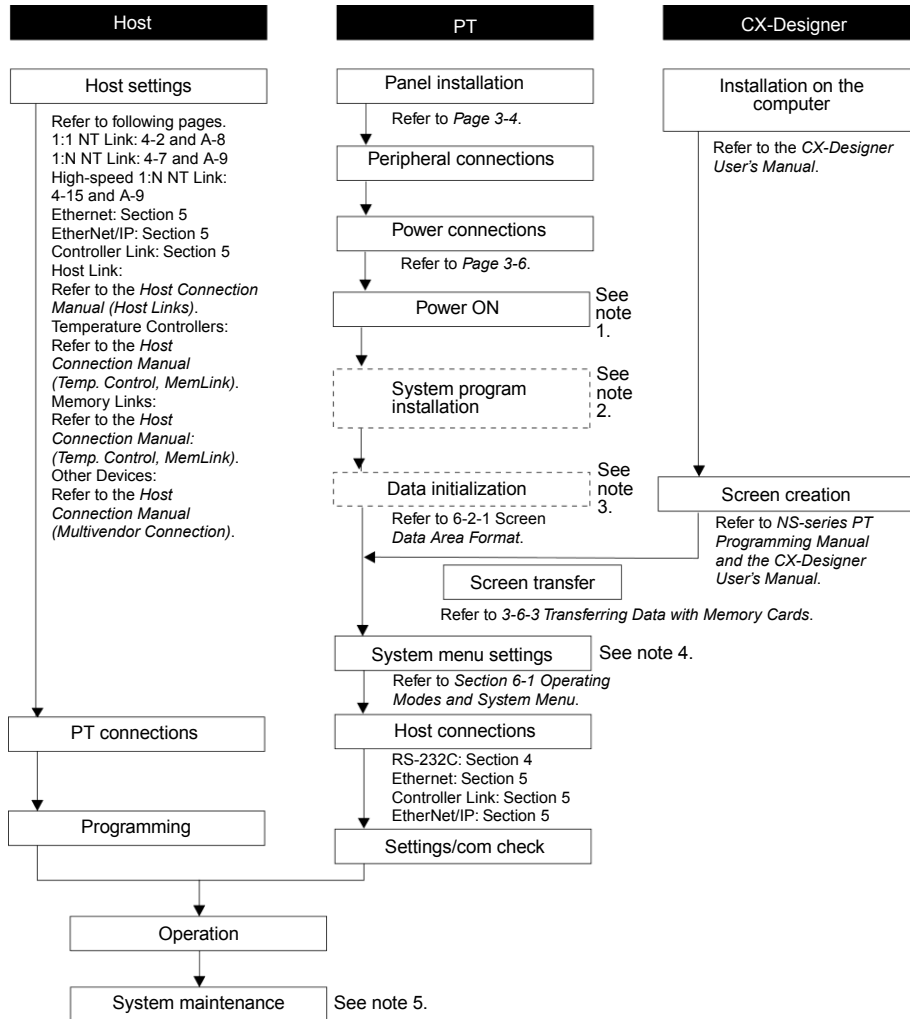

Connecting to Other Devices

- Note 1. RUN mode is entered automatically if screen data already exists.
An error message is displayed if screen data does not exist. Transfer screen data from either the CX-Designer or a Memory Card.
2. The system program is installed in special situations only, such as when the system program is being changed or recovered.
3. The system menu can be operated as required to initialize data saved in the PT.
4. For the NS15, the System Menu can be displayed by pressing one of the four corners of the touch panel twice in a row. For the NS5, NS8, NS10, and NS12, the system menu can be displayed by simultaneously pressing two of the four corners of the touch panel.
5. When errors occur during operation, check I/O and setting statuses as required.

The following table lists the device and software manuals used for reference.

Device/Software	Manual name	Catalog No.
NS-series PTs	Setup Manual (Provides information on existing NS-series models, i.e., NS12, NS10, and NS7.)	V072
	Programming Manual	V073
	Macro Reference	Provided with CX-Designer
CX-Designer	CX-Designer User's Manual	V099
	CX-Designer Online Help	Provided with the CX-Designer.
NS-series Ladder Monitor	NS-series Ladder Monitor Operation Manual	Provided with NS-series Ladder Monitor
PLC	SYSMAC C200HS Installation Guide	W236
	SYSMAC C200HS Operation Manual	W235
	SYSMAC C200HX/HG/HE(-Z) Installation Guide	W302
	SYSMAC C200HX/HG/HE Operation Manual	W303
	SYSMAC C200HX/HG/HE(-ZE) Operation Manual	W322
	SYSMAC CQM1 Operation Manual	W226
	SYSMAC CQM1H Operation Manual	W363
	SYSMAC CV Series CV500/CV1000/CV2000/CVM1 Programming Manual: Ladder Diagrams	W202
	SYSMAC CPM1A Operation Manual	W317
	SYSMAC CPM2A Operation Manual	W352
	SYSMAC CPM1/CPM1A/CPM2A/CPM2C/SRM1(-V2) Programming Manual	W353
	SYSMAC CPM2C Operation Manual	W356
	CP-series CP1H/CP1L CPU Unit Programming Manual	W451
	CP-series CP1L CPU Unit Operation Manual	W462
	CP-series CP1H CPU Unit Operation Manual	W450
	SYSMAC CJ Series Operation Manual	W393
	SYSMAC CS/CJ Series Serial Communications Unit and Board Operation Manual	W336
	SYSMAC CS Series Operation Manual	W339
	SYSMAC CS/CJ Series Programming Manual	W394
	SYSMAC CS/CJ Series Instruction Reference Manual	W340
	SYSMAC CS/CJ Series Programming Console Operation Manual	W341
	SYSMAC CS/CJ Series Communications Command Reference Manual	W342
	SYSMAC CJ Series CJ2 CPU Unit Hardware User's Manual	W472
	SYSMAC CJ Series CJ2 CPU Unit Software User's Manual	W473
	SYSMAC CP Series CP1E CPU Unit Hardware User's Manual	W479
	SYSMAC CP Series CP1E CPU Unit Software User's Manual	W480
	SYSMAC CP Series CP2E CPU Unit Hardware USER'S MANUAL	W613
	SYSMAC CP Series CP2E CPU Unit Software USER'S MANUAL	W614
	NJ/NX-series CPU Unit Hardware User's Manual	W500
	NJ/NX-series CPU Unit Software User's Manual	W501
	NJ/NX-series CPU Unit Built-in EtherNet/IP Port User's Manual	W506
	NJ/NX-series Troubleshooting Manual	W503
	NX-series CPU Unit Hardware User's Manual	W535
NX-series NX1P2 CPU Unit Hardware User's Manual	W578-E1	
NX-series NX1P2 CPU Unit Built-in I/O and Option Board User's Manual	W579-E1	
NX-series NX102 CPU Unit Hardware User's Manual	W593	
Programming Devices/Software	SYSMAC Support Software Operation Manual: C-series PLCs	W248
	SYSMAC Support Software Operation Manual: CVM1 PLCs	W249
	SYSMAC CPT Operation Manual	W333
	CX-Programmer User Manual	W437
	Sysmac Studio Version 1 Operation Manual	W504

1-4 Procedure for Running NS-series PTs

Device/Software	Manual name	Catalog No.
Ethernet Unit	SYSMAC CS/CJ Series Ethernet Unit Operation Manual	W343
	SYSMAC CVM1/CV Series Ethernet Unit System Manual	W242
	FINS Command Reference Manual	W227
	SYSMAC CS and CJ Series Ethernet Units Operation Manual Construction of Networks	W420
	SYSMAC CS and CJ Series Ethernet Units Operation Manual Construction of Applications	W421
Controller Link Support Board	Controller Link Support Board Operation Manual	W307
	Controller Link Support Board for PCI Bus Operation Manual	W383
Controller Link Unit	Controller Link Unit Operation Manual	W309
EtherNet/IP	SYSMAC CS/CJ Series EtherNet/IP Units Operation Manual	W465
	SYSMAC CS/CJ/NE1S Series EtherNet/IP Unit Operation Manual	Z909

Section 2

Before Connecting

This section provides information on methods for connecting NS-series PTs that must be understood before connecting the host and peripheral devices.

For details on connecting through host link communications, refer to the *Host Connection Manual (Host Link)*. For details on Temperature Controller connections and Memory Link communications, refer to the *Host Connection Manual (Temp. Control, MemLink)*. For details on connecting to other devices, refer to the *Host Connection Manual (Multivendor Connection)*.

2-1	Connecting the Host	2-2
2-1-1	Communications Types and Connection Methods	2-2
2-2	Part Names and Functions	2-8

2-1 Connecting the Host

This section provides details on the networks for hosts that can be used with NS-series PTs.

2-1-1 Communications Types and Connection Methods

• Communications Ports and Methods

All NS-series PTs have two serial ports each. The NS15-TX01□-V2, NS12-TS01(B)-V1/-V2, NS10-TV01(B)-V1/-V2, NS8-TV□1(B)-V1/-V2, NS5-SQ01(B)-V1, NS5-SQ□1(B)-V2, NS5-TQ□1(B), and NS5-MQ□1(B)-V2 each have one Ethernet interface.

A Controller Link Interface Unit can also be mounted to the NS12-TS0□(B)-V1 or NS10-TV0□(B)-V1 to enable Controller Link communications. These communications ports and interfaces can be used for the communications methods shown in the following table.

Communications ports	Supported communications methods
Serial port A	1:1 NT Link 1:N NT Links (See note 1.) For connecting the CX-Designer and for Bar Code Reader input.
Serial port B (See notes 2 and 4.)	1:1 NT Link 1:N NT Links (See note 1.) For connecting the CX-Designer and for Bar Code Reader input.
Ethernet interface	FINS communications EtherNet/IP For connecting the CX-Designer.
Controller Link Interface Unit (See note 3.)	FINS communications Data links

Note 1: A 1:N NT Link can be set for either normal or high-speed communications.

Note 2: With the NS5, *EXP. (Expansion) I/F* on the Comm Tab Page in the System Menu settings can be set to use a communications port in the expansion interface connector. The expansion interface, however, is a future expansion, which cannot yet be used. Always use the serial port B connector. Communications will not be possible on serial port B if the expansion interface is selected in the System Menu settings.

(From Lot No. 01218, the expansion interface connector is not incorporated)

Note 3: Controller Link Interface Units are compatible only with the NS15, NS12 and NS10.

Note 4: With the NS15, the type of communications (RS-232C or RS-422A) can be selected by setting the DIP switch.

The following table shows the possible combinations of communications methods when serial ports A and B are connected to the host at the same time.

Using serial ports A and B at the same time	Supported/not supported
1:1 NT Link + 1:1 NT Link	Supported
1:1 NT Link + 1:N NT Links	Supported
1:N NT Links + 1:N NT Links	Supported

• Converting Communications Type Using RS-232C/RS-422A Converter

OMRON's NS-AL002, NT-AL001, or CJ1W-CIF11 RS-232C/RS-422A Converter can be used to convert the communications type between RS-232C and RS-422A.

• Communications Type and Connection Method Combinations

The following table shows the possible connection methods for each communications type.

1:1 Connection

PT communications type	Host communications type	Supported connection methods	Supported communications methods					Reference page
			1:1 NT Link	1:N NT Links	FINS	Ether-Net/IP	Data Links	
RS-232C	RS-232C		Yes	Yes	No	No	No	P. 4-2 P. 4-11
	RS-422A		Yes	Yes	No	No	No	P. 4-2 P. 4-11
RS-422A (See note 1.)	RS-422A		Yes	Yes	No	No	No	P. 4-2 P. 4-11
Ethernet	Ethernet		No	No	Yes	No	No	P. 5-2
	EtherNet/IP		No	No	No	Yes	No	P. 5-26
Controller Link (See note 2.)	Controller Link		No	No	Yes	No	Yes	P. 5-17

Yes: Connection is possible.

No: Connection is not possible.

Note 1: Possible only with the NS15-TX01□-V2.

Note 2: Only when a Controller Link Interface Unit (NS-CLK21) is mounted.

- RS-422A and RS-232C are isolated in the NT-AL001, but they are not isolated in the NS-AL002 and CJ1W-CIF11.
- The total transmission distance with the NT-AL001 or NS-AL002 is 500 m. The total transmission distance with the CJ1W-CIF11, however, is 50 m. If the transmission path contains both the NT-AL001/NS-AL002 and the CJ1W-CIF11, then the total transmission distance is 50 m.

1:N Connection (Connecting Multiple PTs to a Single Host)

PT communications type	Host communications type	Supported connection methods	Supported communications methods					Reference page
			1:1 NT Link	1:N NT Links	FINS	Ether-Net/IP	Data Links	
RS-232C	RS-422A		No	Yes	No	No	No	P. 4-11
RS-422A (See note 1.)	RS-422A		No	Yes	No	No	No	P. 4-11
Ethernet	Ethernet		No	No	Yes	No	No	P. 5-2
	EtherNet/IP		No	No	No	Yes	No	P. 5-26
Controller Link (See note 2.)	Controller Link		No	No	Yes	No	Yes	P. 5-17

Yes: Connection is possible.

No: Connection is not possible.

Note 1: Possible only with the NS15-TX01□-V2.

Note 2: Only when a Controller Link Interface Unit (NS-CLK21) is mounted.

- RS-422A and RS-232C are isolated in the NT-AL001, but they are not isolated in the NS-AL002 and CJ1W-CIF11.
- The total transmission distance with the NT-AL001 or NS-AL002 is 500 m. The total transmission distance of the CJ1W-CIF11, however, is only 50 m. If the transmission path contains both the NT-AL001/NS-AL002 and the CJ1W-CIF11, then the total transmission distance is 50 m.

N:1 Connection (Connecting Multiple Hosts to a Single PT)

NS-series PT communications	Host communi- cations	Supported connection methods	Supported communications methods					Refere nce page
			1:1 NT Link	1:N NT Links	FINS	Ether- Net/IP	Data Links	
RS-232C	RS-232C		Yes	Yes	No	No	No	P. 4-2 P. 4-11
Ethernet	Ethernet		No	No	Yes	No	No	P. 5-2
	EtherNet/ IP		No	No	No	Yes	No	P. 5-26
Controller Link (See note.)	Controller Link		No	No	Yes	No	Yes	P. 5-17

Yes: Connection is possible.

No: Connection is not possible.

Note: Only when a Controller Link Interface Unit (NS-CLK21) is mounted.

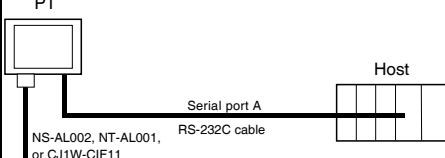
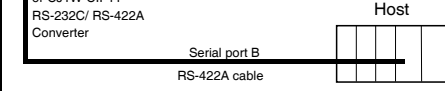
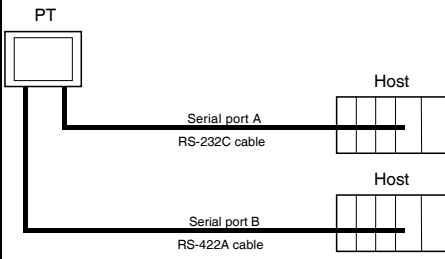
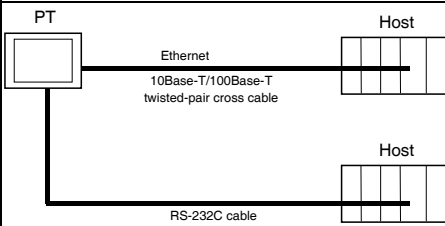
NS-series PT communications	Host communications	Supported connection methods	Supported communications methods				Reference page
			1:1 NT Link	1:N NT Links	FINS	Ether-Net/IP	
RS-232C	RS-232C, RS-422A	 <p>PT</p> <p>Serial port A</p> <p>RS-232C cable</p> <p>Host</p> <p>NS-AL002, NT-AL001, or CJ1W-CIF11</p> <p>RS-232C/RS-422A Converter</p>	Yes	Yes	No	No	P. 4-2 P. 4-11
	RS-422A	 <p>Serial port B</p> <p>RS-422A cable</p> <p>Host</p> <p>An RS-422A line can be connected to serial port A at the same time that an RS-232C line is connected to serial port B. An RS-422A line also can be connected to both serial port A and B at the same time.</p>					
RS-232C, RS-422A (See note.)	RS-232C, RS-422A	 <p>PT</p> <p>Serial port A</p> <p>RS-232C cable</p> <p>Host</p> <p>Serial port B</p> <p>RS-422A cable</p> <p>Host</p>	Yes	Yes	No	No	P. 4-2 P. 4-11
Ethernet, RS-232C	Ethernet, EtherNet/IP, RS-232C	 <p>PT</p> <p>Ethernet</p> <p>10Base-T/100Base-T twisted-pair cross cable</p> <p>Host</p> <p>RS-232C cable</p> <p>Host</p>	Yes	Yes	Yes	Yes	P. 4-2 P. 4-11 P. 5-2

Yes: Connection is possible.

No: Connection is not possible.

Note: Possible only with the NS15-TX01□-V2.

- The NS-AL002, NT-AL001, or CJ1W-CIF11 is connected directly to the serial port of the PT and power is supplied from pin 6 of the port.
- When there are multiple serial ports and Ethernet Units for a single host, each port can be used to communicate with separate PTs. This type of communications method, however, will reduce the communications performance at the host.
- RS-422A and RS-232C are isolated in the NT-AL001, but they are not isolated in the NS-AL002 and CJ1W-CIF11.
- The total transmission distance with the NT-AL001 or NS-AL002 is 500 m. The total transmission distance of the CJ1W-CIF11, however, is only 50 m. If the transmission path contains both the NT-AL001/NS-AL002 and the CJ1W-CIF11, then the total transmission distance is 50 m.

NS-series PT communications	Host communications	Supported connection methods	Supported communications methods					Reference page
			1:1 NT Link	1:N NT Links	FINS	Ether- Net/IP	Data Links	
RS-232C, Controller Link	RS-232C, Controller Link	<p>The diagram shows a PT (Personal Terminal) connected to a Host. Two connection methods are shown: 1) A direct connection using a 'Serial port A RS-232C cable'. 2) A connection through a 'Controller Link Interface Unit' using 'Specified shielded twisted-pair cable' and 'Controller Link'.</p>	Yes	Yes	Yes	Yes	Yes	P. 4-2 P. 4-11 P. 5-26
Ethernet, Controller Link	Ethernet, Ether- Net/IP, Controller Link	<p>The diagram shows a PT connected to a Host. Two connection methods are shown: 1) A direct connection using 'Ethernet' and '10BASE-T/100BASE-T Twisted-pair cross cable'. 2) A connection through a 'Controller Link Interface Unit' using 'Specified shielded twisted-pair cable' and 'Controller Link'.</p>	No	No	Yes	Yes	Yes	P. 5-2 P. 5-17 P. 5-26

Yes: Connection is possible.

No: Connection is not possible.

Note: Only when a Controller Link Interface Unit (NS-CLK21) is mounted.

- When there are multiple serial ports and Ethernet Units for a single host, each port can be used to communicate with separate PTs. This type of communications method, however, will reduce the communications performance at the host.

2-2 Part Names and Functions

The part names and functions of the PT are described here.

NS15 Front Panel

RUN Indicator
Lights or flashes to indicate the status of the PT

The brightness of the indicator will change according to the brightness setting of the backlight. The brightness will not change on PTs with lot number 30114 or earlier.

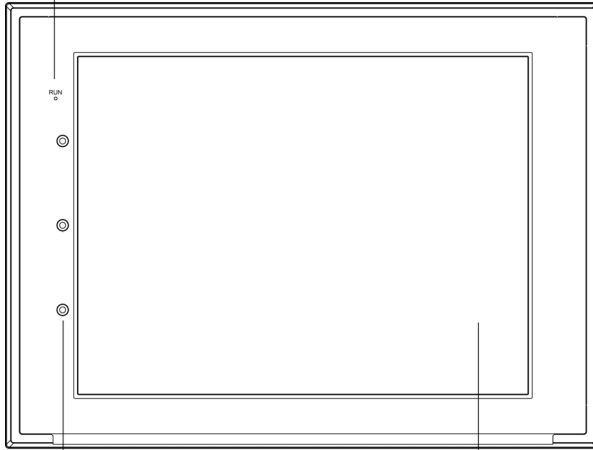

Function Keys
The Function Keys are an added safety measure that are used to require the operator to press an input object on the touch panel twice to enable function keys.

Display
NS15: 15-inch High-luminance TFT Color LCD

Indicator	Green	Orange	Red
Lit	PT is operating normally.	<ul style="list-style-type: none"> The file system check that is performed immediately after the power is turned ON is in progress. The battery power is low, or the battery is not connected and the PT is operating normally. 	An error occurred at startup.
Flashing	Memory Card transfer ended normally. A backlight error occurred immediately after power was turned ON.	Memory Card transfer in progress.	Memory Card transfer ended abnormally.
Not lit	<ul style="list-style-type: none"> Power is not being supplied to the PT. The fuse is broken. The system program is damaged and the system cannot be booted. 		

NS15 Rear Panel Switches

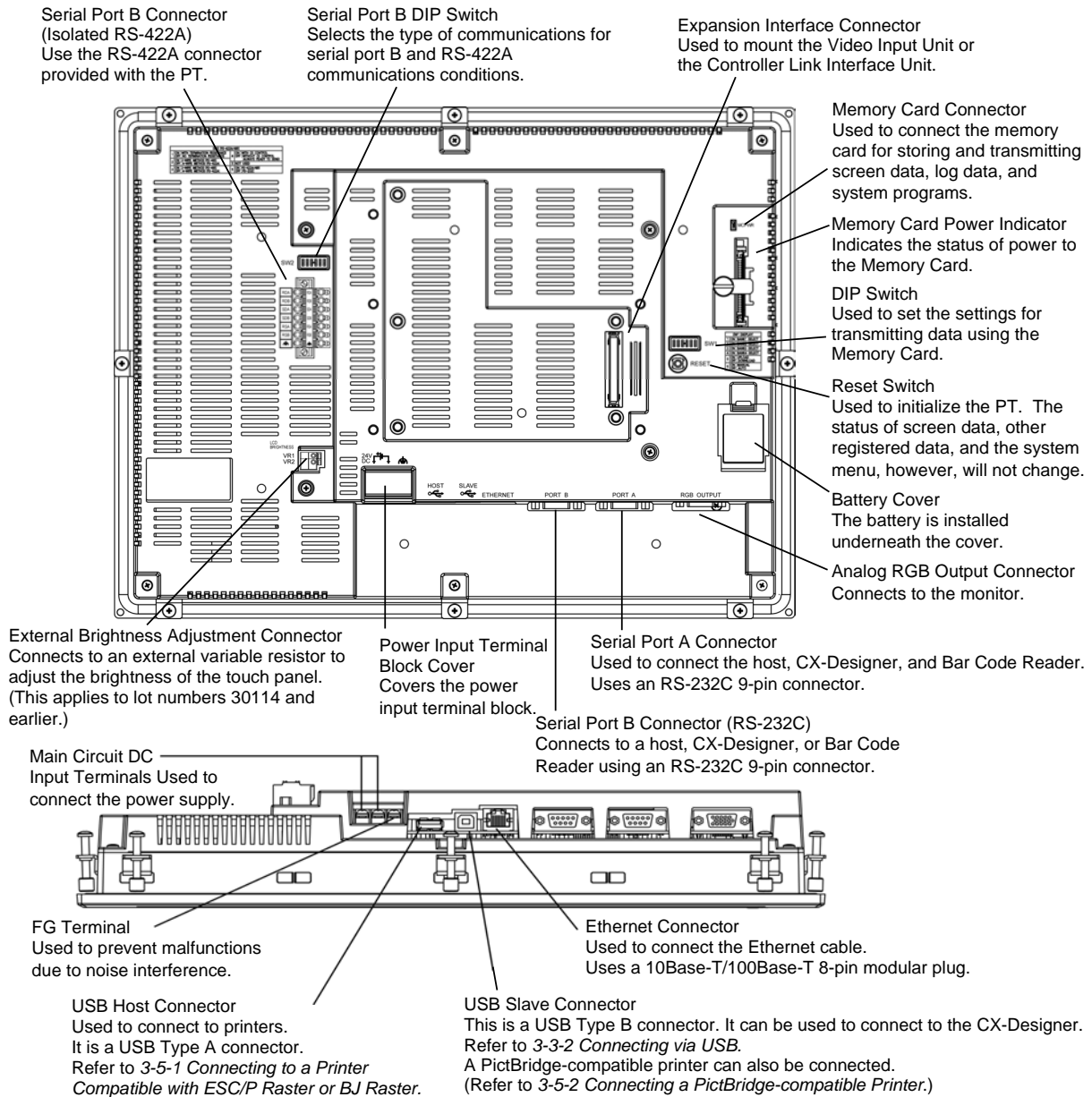

*: **The NS-CLK21 can be used.**
The NS-CA001 cannot be used.
The NS-CA002 can be used for analog RGB input, but not for video input.

Precautions for Safe Use

Confirm system safety before turning the power ON/OFF or restarting. Otherwise the system may operate unpredictably.

Precautions for Correct Use

- There are two connectors that can be used for serial port B, an isolated RS-422A connector and an RS-232C connector. They cannot be used at the same time. Set the DIP switch pins for the serial port B setting to specify the port that is to be used.
- When using RS-422A communications, use the RS-422A connector included with the PT for the isolated RS-422A serial port B connector.

NS12/NS10 Front Panel

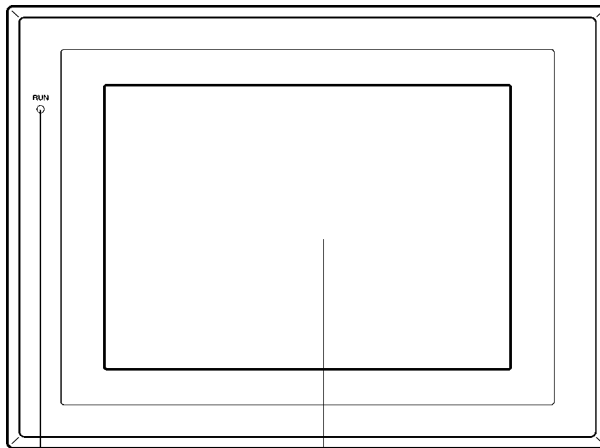

RUN indicator

Lights or flashes to indicate the status of the PT.

The brightness of the indicator will change according to the brightness setting of the backlight.

(The brightness cannot be changed on NS10 PTs with lot number 10Y1 or earlier and on NS12 PTs with lot number 13Z1 or earlier.)

Display

NS12: 12.1-inch TFT high-luminance LCD

NS10: 10.4-inch TFT high-luminance LCD

The entire display is a touch panel that serves as an input device.

RUN Indicator Status

Indicator	Green	Orange	Red
Lit	PT is operating normally.	<ul style="list-style-type: none"> The file system check that is performed immediately after the power is turned ON is in progress. The battery power is low, or the battery is not connected and the PT is operating normally. 	An error occurred at startup.
Flashing	Memory Card transfer ended normally. A backlight error occurred immediately after power was turned ON.	Memory Card transfer in progress.	Memory Card transfer ended abnormally.
Not lit	<ul style="list-style-type: none"> Power is not being supplied to the PT. The fuse is broken. The system program is damaged and the system cannot be booted. 		

NS12/NS10 Rear Panel Switches

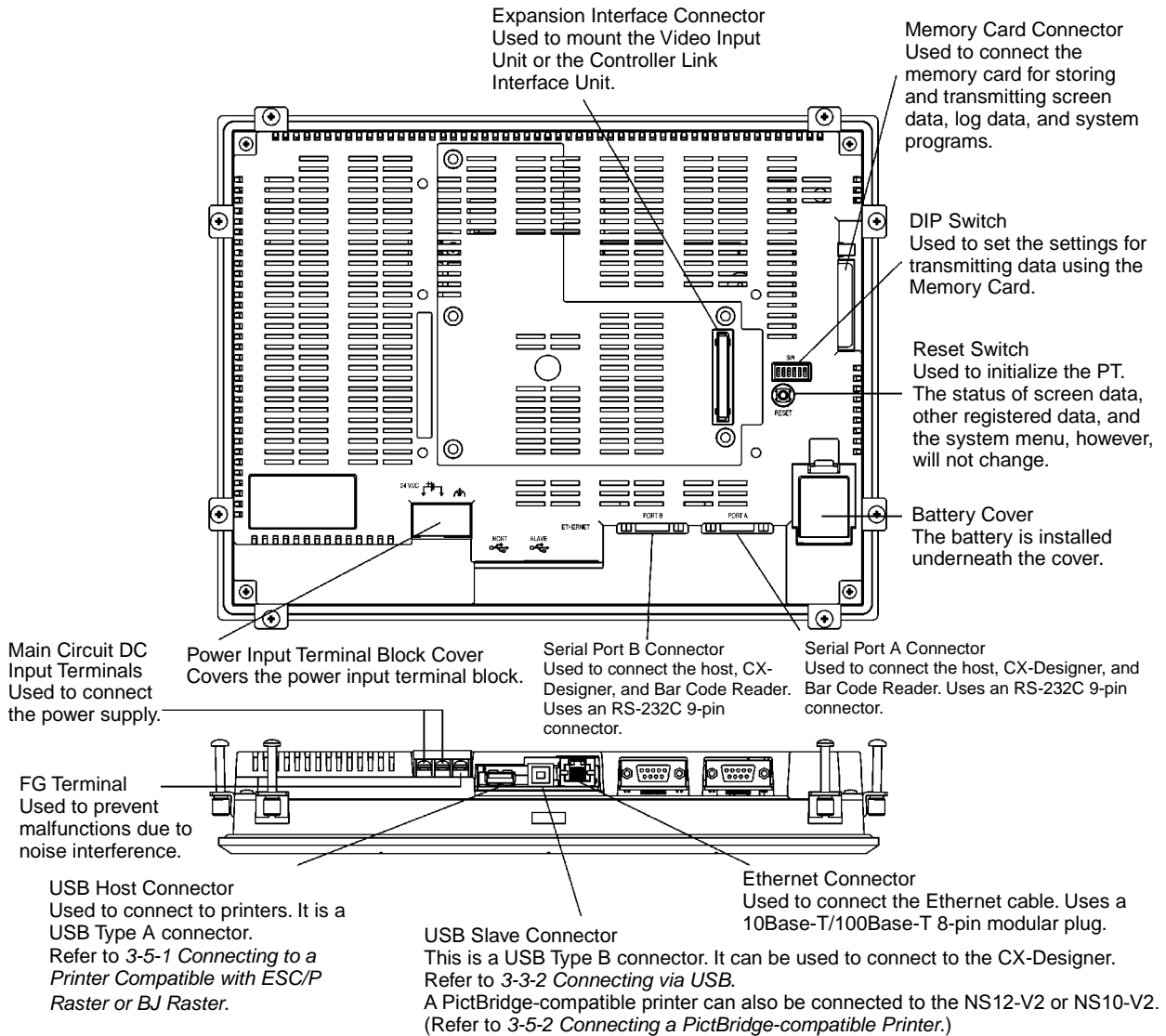

Precautions for Safe Use

Confirm system safety before turning the power ON/OFF or restarting. Otherwise the system may operate unpredictably.

NS8 Front Panel

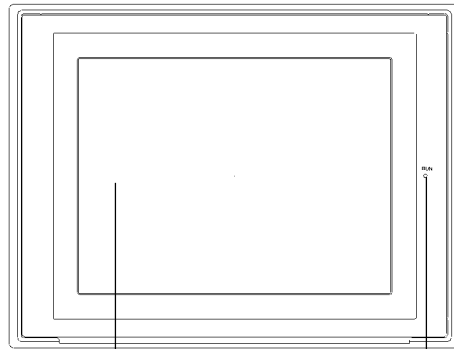

Display
 NS8-TV□□-V2: P8.4-inch TFT high-luminance color LCD
 NS8-TV□□-V1: P8.0-inch TFT high-luminance color LCD
 The entire display is a touch panel that serves as an input device.

RUN indicator
 Lights or flashes to indicate the status of the PT.
 The brightness of the indicator will change according to the brightness setting of the backlight.
 (The brightness will not change on PTs with lot number 27X1 or earlier.)

RUN Indicator Status

Indicator	Green	Orange	Red
Lit	PT is operating normally.	<ul style="list-style-type: none"> The file system check that is performed immediately after the power is turned ON is in progress. The battery power is low, or the battery is not connected and the PT is operating normally. 	An error occurred at startup.
Flashing	<ul style="list-style-type: none"> Memory Card transfer ended normally. A backlight error was detected when power was turned ON. 	Memory Card transfer in progress.	Memory Card transfer ended abnormally.
Not lit	<ul style="list-style-type: none"> Power is not being supplied to the PT. The fuse is broken. The system program is damaged and the system cannot be booted. 		

NS8 Rear Panel

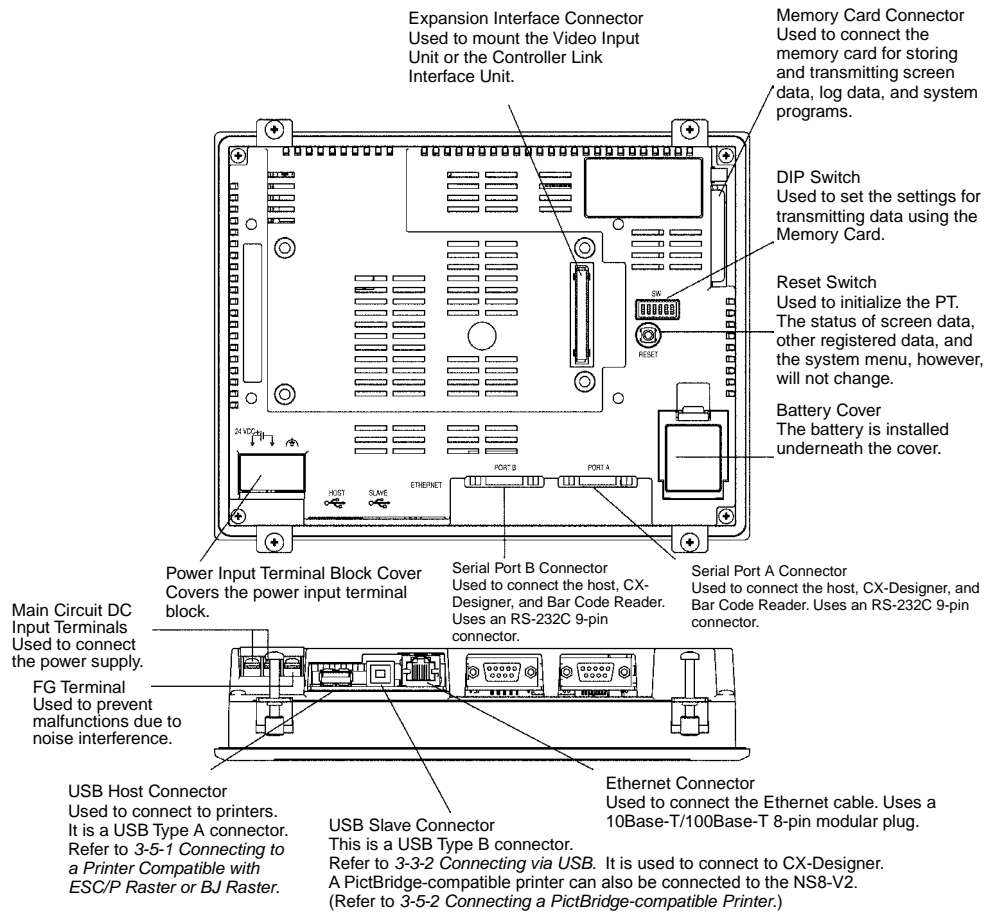

Precautions for Safe Use

Confirm system safety before turning the power ON/OFF or restarting. Otherwise the system may operate unpredictably.

NS5 Front Panel

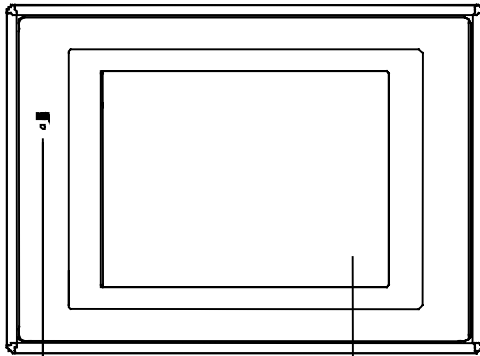

RUN indicator
 Lights or flashes to indicate the status of the PT. The brightness of the indicator will change according to the brightness setting of the backlight. (This applies only to the NS5-SQ1/-TQ1.) (The brightness of the indicator will not change for lot number 14Z0 or earlier.)

Display
 5.7-inch LCD
 The entire display is a touch panel that serves as an input device. The colors toward the edges may become lighter on the NS5-MQ. This is a characteristic of STN LCDs, and does not indicate a problem.

RUN Indicator Status

Indicator	Green	Orange	Red
Lit	PT is operating normally.	<ul style="list-style-type: none"> The file system check that is performed immediately after the power is turned ON is in progress. The battery power is low, or the battery is not connected and the PT is operating normally. 	An error occurred at startup.
Flashing	<ul style="list-style-type: none"> Memory Card transfer ended normally. A backlight error was detected when power was turned ON. 	Memory Card transfer in progress.	Memory Card transfer ended abnormally.
Not lit	<ul style="list-style-type: none"> Power is not being supplied to the PT. The fuse is broken. The system program is damaged and the system cannot be booted. 		

NS5 Rear Panel

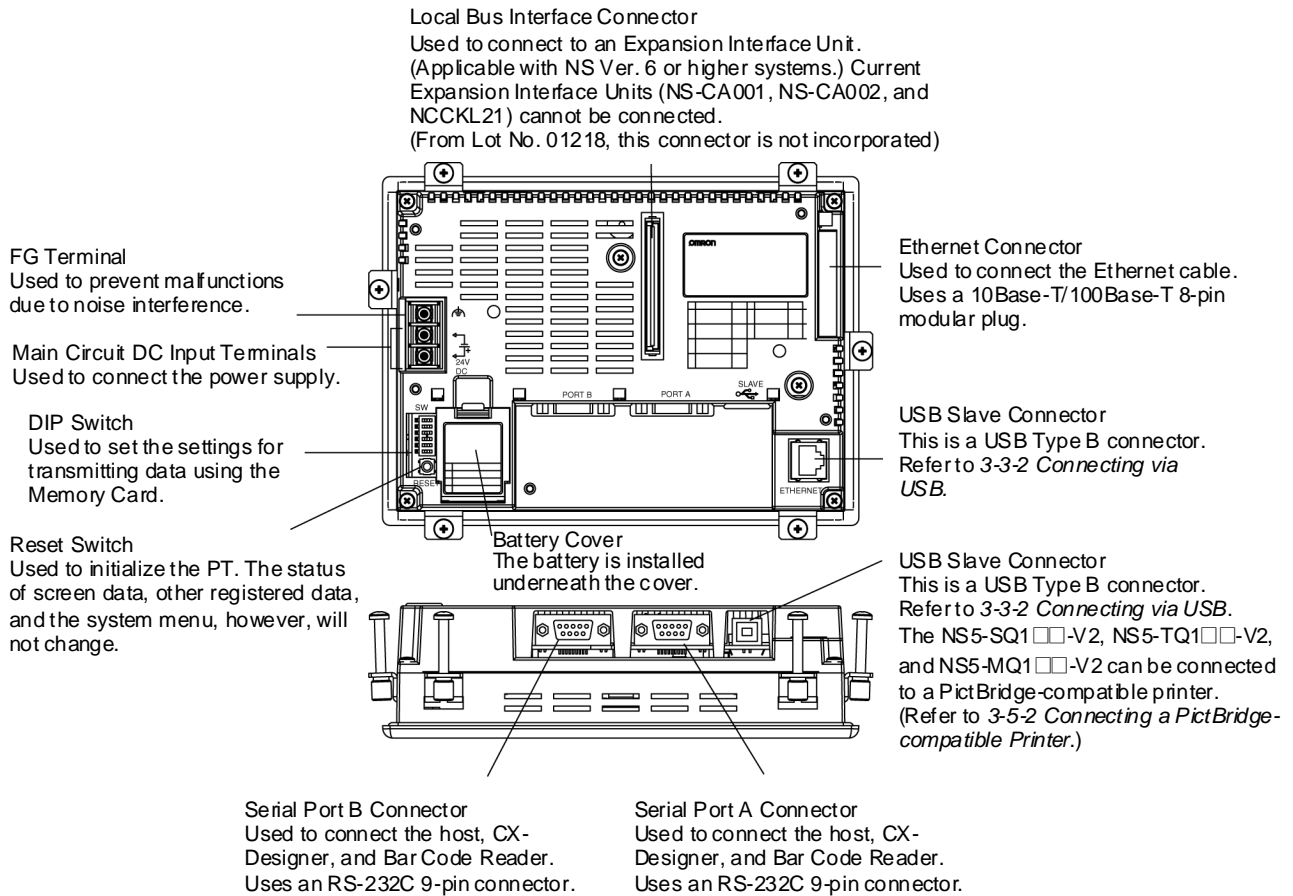

Precautions for Safe Use

Confirm system safety before turning the power ON/OFF or restarting. Otherwise the system may operate unpredictably.

Touch Panel (NS15)

The touch switches on the front panel of the PT are used to perform input operations. Press the touch switches to perform operations such as switching screens and sending bit status to the host.

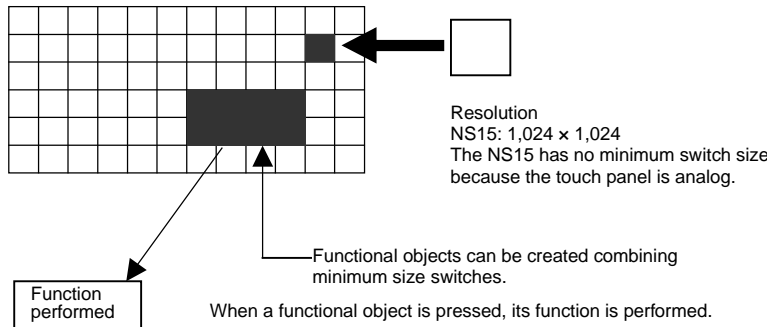

To ensure correct input operations, create touch switches so that they consist of at least 32 x 32 dots.

WARNING

The NS15-TX01□-V2 uses an analog touch panel. Never press more than two points on the panel at a time. Otherwise, it may activate a switch somewhere between the two points.

Precautions for Safe Use

- Press the touch switches with a pressure of 30 N max.
- Do not press the touch switches when the backlight is not lit or when there is no display.
- Check system safety before pressing the touch switches.
- Inputs may not be recognized if the touch switches are pressed in rapid succession. Check that one input operation has finished before performing the next one.
- A touch position detection error of up to 10 pixels may occur due to the precision of the NS15-TX01□-V2 touch panel. Always take this into account when positioning functional objects on the panel so adjoining objects will not be activated by mistake.

Precautions for Correct Use

- If you touch a point on the panel away from any object and then slide your finger on the panel until it rests on a functional object on the NS15-TX01□-V2, that functional object will not be activated. You must remove your finger completely from the panel and then touch the functional object directly to activate that object.

Reference

• Pressing Three Switches Simultaneously

When the positions of multiple touch switches are set as shown in the example and three switches are pressed simultaneously, the touch switches will malfunction due to structural characteristics.

Position the touch switches carefully. In the example shown below, switches have been created in positions A and B, and at points C and D, where the vertical and horizontal lines through A and B intersect.

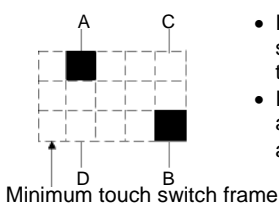

- If touch switches A, B, and C are turned ON simultaneously, switch D may also turn ON due to the structure of the touch panel.
- In the same way, if touch switches A, B, and D are turned ON simultaneously, switch C may also turn ON.

Touch Panel (NS12/10/8/5)

The touch switches on the front panel of the PT are used to perform input operations. Press the touch switches to perform operations such as switching screens and sending bit status to the host.

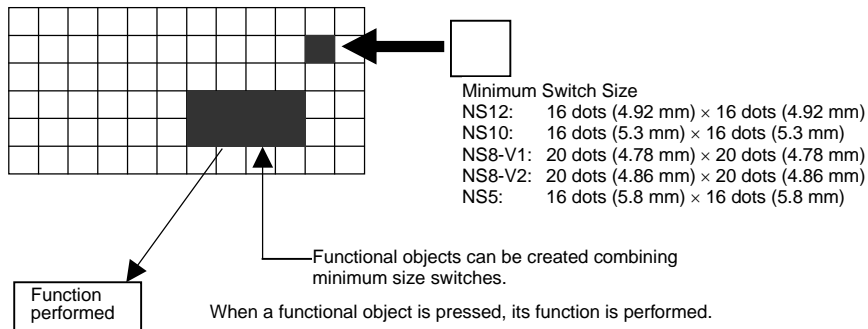

To ensure correct input operations, create touch switches so that they consist of at least two switches horizontally and vertically.

Precautions for Safe Use

- Press the touch switches with a pressure of 30 N max.
- Do not press the touch switches when the backlight is not lit or when there is no display.
- Check system safety before pressing the touch switches.

Precautions for Correct Use

- If you touch a point on the panel away from any object and then slide your finger on the panel until it rests on a functional object on the NS15-TX01□, that functional object will not be activated. You must remove your finger completely from the panel and then touch the functional object directly to activate that object.

Reference • Pressing Three Switches Simultaneously

When the positions of multiple touch switches are set as shown in the example and three switches are pressed simultaneously, the touch switches will malfunction due to structural characteristics.

Position the touch switches carefully. In the example shown below, switches have been created in positions A and B, and at points C and D, where the vertical and horizontal lines through A and B intersect.

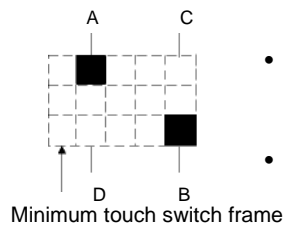

- If touch switches A, B, and C are turned ON simultaneously, switch D may also turn ON due to the structure of the touch panel.
- In the same way, if touch switches A, B, and D are turned ON simultaneously, switch C may also turn ON.

Connector Pin Arrangement of Serial Ports A and B

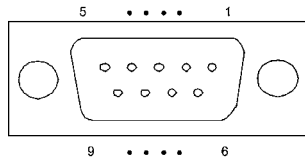

Pin number	Signal name	Name
1	NC	Not connected.
2	SD	Send data
3	RD	Receive data
4	RS	Request to send
5	CS	Clear to send
6	+5V	5-V output (250 mA max.)
7	NC	Not connected.
8	NC	Not connected.
9	SG	Signal ground

Precautions for Correct Use

Make sure that the total current capacity of devices being supplied power is 250 mA max. before using the 5-V power supply from pin 6. The capacity of the PT's 5-V output is 250 mA max. at 5 V ±5%.

Connector Pin Arrangement of Serial Port B (Isolated RS-422A) (NS15 Only)

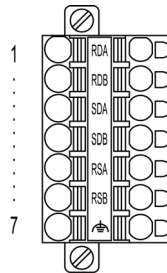

Pin number	Signal name	Name
1	RDA	Receive data (-)
2	RDB	Receive data (+)
3	SDA	Send data (-)
4	SDB	Send data (+)
5	RSA	Request to send (-)
6	RSB	Request to send (+)
7	⏏	Functional ground

Precautions for Correct Use

A screwdriver that is thin only at the tip will not fit all the way into the hole. Use a small flat-blade screwdriver with a consistent thickness. The tightening torque is 0.4 to 0.5 N·m.

Ethernet Connector Pin Arrangement

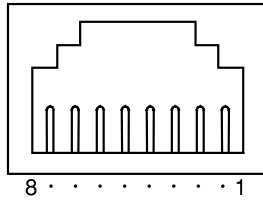

Pin number	Signal name	Name
1	TD+	Twisted-pair output (differential output)
2	TD-	Twisted-pair output (differential output)
3	RD+	Twisted-pair input (differential input)
4	BI_D+	Protection circuit
5	BI_D-	Protection circuit
6	RD-	Twisted-pair input (differential input)
7	BI_D+	Protection circuit
8	BI_D-	Protection circuit

When using a cable with a hood (or boot), make sure that the length for connection is at least 15 mm, as shown in the following diagram.

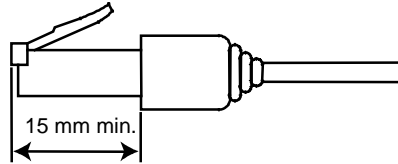

Analog GRGB output connector (NS15 Only)

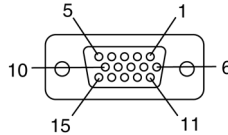

Pin No.	Signal name	
1	GND	GND
2	NC	Not used
3	BLUE	Blue video signal
4	GREEN	Green video signal
5	RED	Red video signal
6	GND	GND
7	NC	Not used
8	B_GND	Blue video signal GND
9	G_GND	Green video signal GND
10	R_GND	Red video signal GND
11	NC	Not used
12	VSYNC	Vertical sync signal
13	HSYNC	Horizontal sync signal
14	NC	Not used
15	NC	Not used

External Brightness Adjustment Connector (NS15 30114 or Earlier Only)

You can connect this connector to an external variable resistor to adjust the brightness of the backlight of the PT.

Section 3

Installing the PT and Connecting Peripheral Devices

This section describes the methods used to install the PT and connect peripheral devices.

For details on methods for connecting the host, refer to Section 4 Connecting the Host to Serial Port or Section 5 Connecting to Host via Ethernet or Controller Link.

3-1	Installing the PT.....	3-3
3-1-1	Installation Environment.....	3-3
3-1-2	Installing RS-232C/RS-422A Converters.....	3-3
3-1-3	Mounting the PT to the Control Panel.....	3-4
3-1-4	Connecting the Power Supply.....	3-7
3-1-5	Wiring the Ground Wire.....	3-8
3-1-6	Peripheral Device Connection Limitations.....	3-8
3-2	Starting the PT.....	3-10
3-2-1	Operation at Startup.....	3-10
3-2-2	Starting the PT for the First Time.....	3-12
3-3	Connecting the CX-Designer.....	3-14
3-3-1	Connecting via RS-232C or Ethernet.....	3-14
3-3-2	Connecting via USB.....	3-14
3-3-3	Connecting via a Modem.....	3-16
3-4	Connecting to Bar Code Readers.....	3-17
3-4-1	Connection Methods.....	3-17
3-4-2	Setting Bar Code Readers.....	3-18
3-4-3	Data Format.....	3-19
3-4-4	Bar Code Input.....	3-19
3-5	Connecting to Printers.....	3-20
3-5-1	Connecting to a Printer Compatible with ESC/P Raster and BJ Raster.....	3-20
3-5-2	Connecting a PictBridge-compatible Printer.....	3-21
3-6	Using Memory Cards.....	3-23
3-6-1	Installation.....	3-24
3-6-2	Replacing the System Program.....	3-25
3-6-3	Transferring Data with Memory Cards.....	3-26
3-7	Installing the Video Input Unit.....	3-32
3-7-1	Video Input Unit Components.....	3-32
3-7-2	Nomenclature and Functions.....	3-33
3-7-3	Installation Method for Video Input Unit.....	3-34

3-1 Installing the PT

3-7-4	Connecting to Video Input Connectors	3-39
3-8	Installing the Controller Link Interface Unit	3-44
3-8-1	Controller Link Interface Unit Components.....	3-44
3-8-2	Nomenclature and Functions.....	3-45
3-8-3	Installation Method for Controller Link Interface Unit.....	3-48
3-8-4	Wiring	3-55
3-9	Connecting a Monitor	3-61
3-10	External Brightness Adjustment	3-62
3-11	RS-232C/RS-422A Selector DIP Switch.....	3-63

3-1 Installing the PT

The methods used to mount the PT to the control panel and connect the power supply are described here.

3-1-1 Installation Environment

Always mount the PT to the control panel and perform other installation procedures according to the following precautions.

**Precautions
for Correct Use**

Do not install the PT in any of the following locations:

- Locations subject to extreme temperature changes.
- Locations subject to temperatures or humidity outside the ranges in the specifications.
- Locations subject to high humidity that may result in condensation.
- Locations that would subject the PT to chemicals.
- Locations that would subject the PT to oil.
- Locations subject to corrosive or flammable gases.
- Locations that would subject the PT to direct shock or vibration.
- Locations that would directly expose the PT to wind or rain.
- Locations subject to strong ultraviolet light.

Provide proper shielding measures when installing in the following locations:

- Locations subject to static electricity or other sources of noise.
 - Locations subject to strong electromagnetic fields.
 - Locations near to power supply lines.
 - Locations subject to possible exposure to radiation.
-

**Precautions
for Safe Use**

When unpacking the PT and peripheral devices, check for any external damage. Shake the product gently and check for any abnormal sounds.

3-1-2 Installing RS-232C/RS-422A Converters

When using RS-232C/RS-422A Converters, mount the PT to the control panel before installing these Units.

For details on installing and removing RS-232C/RS-422A Converters, refer to *Appendix 3 Using NS-AL002 Converters*.

3-1-3 Mounting the PT to the Control Panel

The PT is flush-mounted to the control panel.

The PT is mounted using the panel mounting brackets provided with the PT, and tools, such as a Phillips screwdriver.

Use the following procedure to mount the PT to the control panel.

1. Make a hole in the panel for flush mounting according to the following dimensions and insert the PT from the front of the panel.

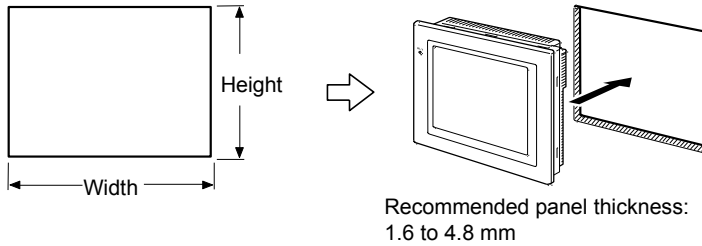

Model	Dimensions
NS15	Width 383.5 $^{+1}_0$ × Height 282.5 $^{+1}_0$ mm
NS12	Width 302 $^{+1}_0$ × Height 228 $^{+1}_0$ mm
NS10	Width 302 $^{+1}_0$ × Height 228 $^{+1}_0$ mm
NS8	Width 220.5 $^{+0.5}_0$ × Height 165.5 $^{+0.5}_0$ mm
NS5	Width 184 $^{+0.5}_0$ × Height 131 $^{+0.5}_0$ mm

Reference A NS-USBEXT-1M USB Relay Cable can be used to place a USB slave connector on the front of the control panel. To use a USB Relay Cable, mount the Cable connector in a panel cutout with the following dimensions.

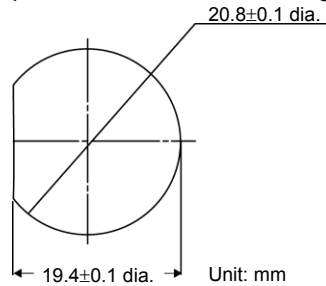

Secure the panel mounting brackets from the back of the panel, as shown in the following diagram.

Insert the catch on each bracket into the square hole on the PT, and secure the PT to the panel by pulling in the PT.

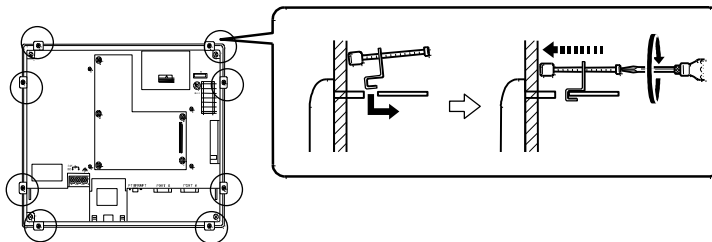

Precautions for Safe Use

- Do not allow metal particles to enter the PT while work is being performed on the panel.
- The allowable thickness of the panel for mounting is between 1.6 and 4.8 mm.

Secure the mounting bracket with a uniform tightening torque of between 0.5 and 0.6 N·m to keep the PT waterproof and dustproof.

The front sheet may become distorted if the tightening torque is more than the specified limit or not uniform. Always use a panel that is clean, undistorted, and strong enough to adequately withstand mounting the PT.

Precautions for Safe Use

This product conforms to shipbuilding standards. The shipbuilding standards have conditions that may make them unusable depending on the location in which the PT is installed. When using a PT on a ship, be sure to contact your OMRON sales representative.

Shipping Standards (NK, LR, ABS, BV, DNV, KR, GL)

The conditions for use in locations other than the bridge or deck are as follows:

- The NS-series PT must be installed in a control panel.
- The control panel must be equipped with an air conditioner.
- The entire surface of the NS-series PT must be covered with electromagnetic shielding (specified below) that is also grounded using conductive tape (e.g., copper tape).
- Gaps in the door of the control panel must be completely filled or covered with gaskets or other material.
- Gaps between the PT and the panel cutout must be completely covered with conductive tape, such as copper tape, and the PT must be secured using mounting brackets.

The conditions for use on a bridge (Class NK, LR, or DNV certification only) are as follows:

- The NS-series PT must be installed in a control panel.
- The control panel must be equipped with an air conditioner.
- The entire surface of the NS-series PT must be covered with electromagnetic shielding that is also grounded using conductive tape (e.g., copper tape).
- Gaps in the door of the control panel must be completely filled or covered with gaskets or other material.
- Gaps between the PT and the panel cutout must be completely covered with conductive tape, such as copper tape, and the PT must be secured using mounting brackets.
- The following noise filter must be connected to the 0 to 24 VDC power line.

Electromagnetic Shielding

Manufacturer	Zippertubing (Japan), Ltd.
Model	SWF132075

* Electromagnetic shielding reduces the permeability by approximately 50%.

Noise Filter

Manufacturer	Cosel
Model	TAH-06-683

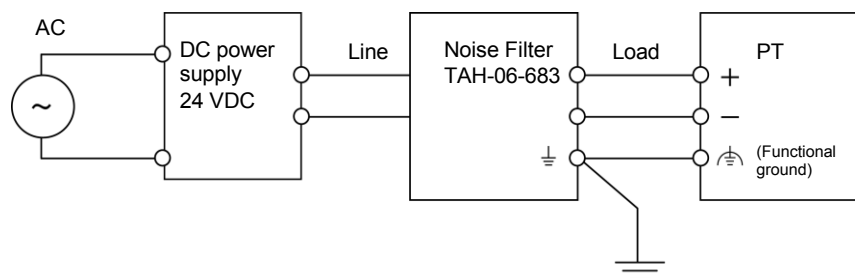

3-1 Installing the PT

Reference To obtain IP65 oil-proof when mounting an NS-series PT, secure it with the mounting brackets as shown in the following figures.

- **NS15**

Secure the PT using at least the following 8 mounting locations of the total of 16 mounting locations.

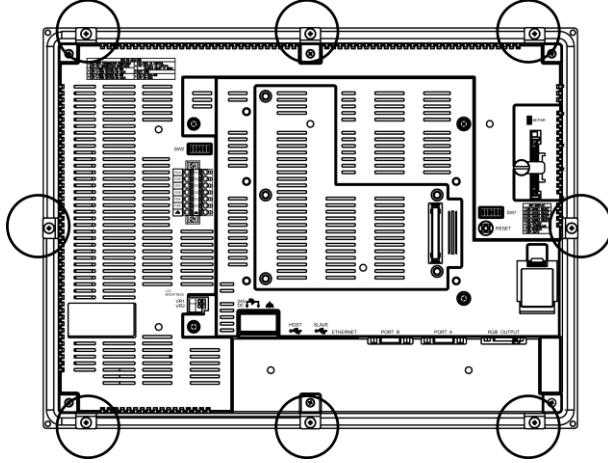

- **NS12/NS10**

Secure the PT using at least the following 8 mounting locations of the total of 14 mounting locations.

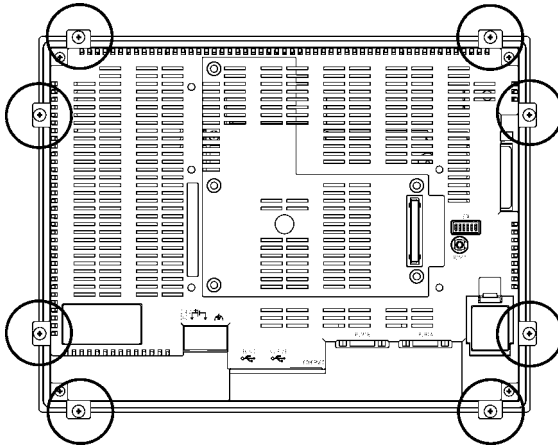

- **NS8**

Secure the PT using all 4 of the mounting locations.

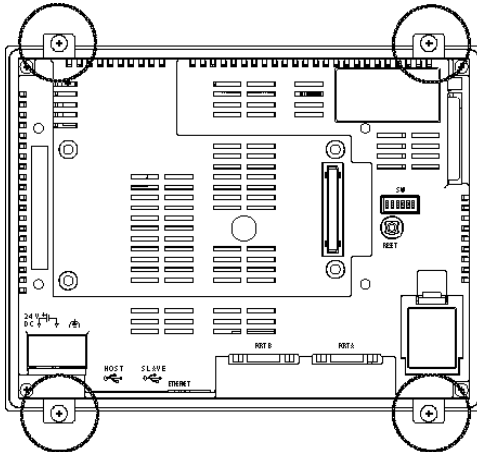

• **NS5**

Secure the PT using all 6 of the mounting locations.

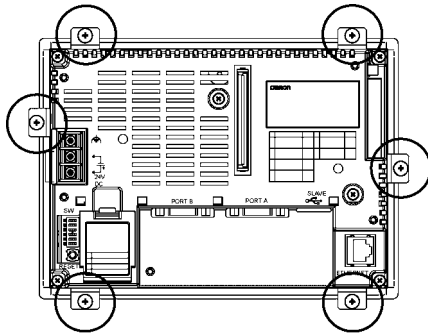

3-1-4 Connecting the Power Supply

Connect a 24-VDC power supply to the power input terminals.

Precautions for Safe Use

- Do not connect an AC power supply to the power terminals.
- Use a DC power supply with low voltage fluctuation.
- Do not perform a dielectric strength test.
- To conform to EC Directives, use a DC power supply that will provide a stable output even if the input is momentarily interrupted for 10 ms, and that has reinforced or double insulation.

• **Power Supply**

The following table shows the specifications for the power supply that can be connected. Determine power supply specifications that meet the power supply capacity requirements.

Item	Value
Power supply voltage	24 VDC
Allowable voltage range	20.4 to 27.6 VDC (24 VDC \pm 15%)
Power supply capacity	45 W min. (NS15) 25 W min. (NS12, NS10, NS8) 15 W min. (NS5)

NS15, 12, 10, 8

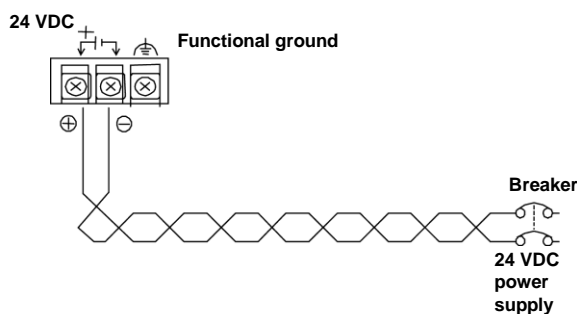

NS5

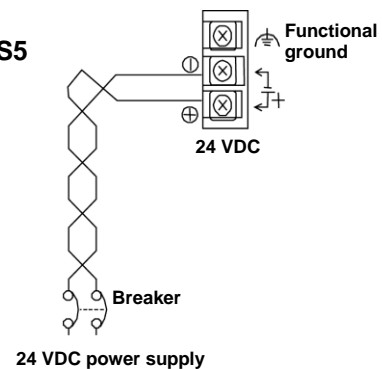

• **Parts Used to Connect the Power Supply**

Precautions for Safe Use

Connect power to the power terminal block using twisted-pair power lines with a AWG14 to 20 and always using M3.5 crimp terminals. The correct tightening torque for the terminal block is 0.8 N·m. Tighten terminal block screws properly.

3-1 Installing the PT



• Recommended Products

Manufacturer	Model number of forked terminals	Model number of round terminals	Applicable power lines (twisted-pair)
J.S.T. Mfg. Co., Ltd.	2-YS3A	2-3.5	2.0 to 2.63 mm ²
Fuji Terminal Industry Co., Ltd.	2-YAS3.5	V2-S3.5	
Nichifu Terminal Industries Co., Ltd.	2Y-3.5	2-3.5	

Precautions for Safe Use

When surge noise occurs in the DC power supply, connect a Transistor Voltage Suppressor (TVS) between the 24-V and 0-V DC terminals.
 Recommended TVS model: 1.5KE33CA
 Manufacturers: Vishay Intertechnology Inc, ST Microelectronics

3-1-5 Wiring the Ground Wire

The PT is provided with a functional ground (FG: ) terminal.

Wire the FG terminal according to the following conditions.

1. Ground according to *Figure* when there is difference in potential between the PT and host. Do not ground the functional ground of the PT if it is far from the host and one-point grounding is difficult.
2. Do not ground the functional ground (FG: ) of the PT if it is mounted to the same panel as devices that generate noise, such as motors and inverters.

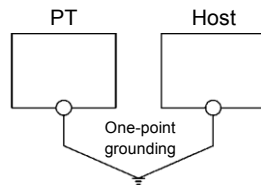

Precautions for Correct Use

Ground correctly to prevent malfunctions caused by noise.

3-1-6 Peripheral Device Connection Limitations

Select one of the following combinations when devices requiring power supply are connected to port A, port B, and an Expansion Interface Unit on the PT. Use a 5-V Bar Code Reader with a current consumption of 250 mA or the equivalent.

Port A and B connection combinations	Expansion Interface Unit (NS-CA001, NS-CA002, NS-CLK21)
When a Bar Code Reader and the NS-AL002 are connected to ports A and B at the same time	Cannot be used
When a Bar Code Reader and the CJ1W-CIF11 are connected to ports A and B at the same time	Cannot be used
When a Bar Code Reader and the NT-AL001 are connected to ports A and B at the same time	Cannot be used
When the CJ1W-CIF11 and CJ1W-CIF11 are connected to ports A and B at the same time	Can be used
When the CJ1W-CIF11 and NS-AL002 are connected to ports A and B at the same time	Can be used
When the CJ1W-CIF11 and NT-AL001 are connected to ports A and B at the same time	Cannot be used

Port A and B connection combinations	Expansion Interface Unit (NS-CA001, NS-CA002, NS-CLK21)
When two NT-AL001s are connected to ports A and B at the same time	Cannot be used
When a Bar Code Reader is connected to port A or B	Can be used
When the CJ1W-CIF11 is connected to port A or B	Can be used
When the NS-AL002 is connected to port A or B	Can be used
When the NT-AL001 is connected to port A or B	Can be used
When Bar Code Readers are connected to ports A and B at the same time	Cannot be used
When the NT-AL001 and NT-AL002 are connected to port A or B at the same time	Cannot be used

3-2 Starting the PT

Check that the hardware is connected properly, turn ON the power to the PT, and then start the PT.

Use the following procedure to start the PT.

3-2-1 Operation at Startup

When the power is ON or the PT is reset, the PT will operate as follows:

Indicator lights orange.

Immediately after the power is turned ON, the indicator will light orange.

The file system will be checked and the system recovered if the power was turned OFF while a file was being written in previous operation, or if the battery capacity was low and drive safety information from the system program area screen data area could not be saved.

↓

Indicator lights green.

When the system starts properly, the indicator will light green.

If the indicator does not light green, the system programs may be damaged. Contact your nearest OMRON representative.

↓

Startup message is displayed.

A message about the startup status will be displayed.

If an error occurs, the PT will stop startup procedures and display a message. (Refer to *Section 5 Troubleshooting* in the *Programming Manual*.)

If an error occurs that allows startup to continue, a warning will be displayed. When a warning is displayed, the PT will enter standby state and wait for touch input. Check the message and then touch the screen. The PT will continue with startup procedures.

```

Welcome to NS series!
Version: X.XX ■
Hardware Devices : OK
Now Loading System Program...
Now Loading Fonts...
  Load Complete

```



PT starts operating

The PT goes into RUN mode and starts operating according to the screen data in the PT. When the PT is connected using communications conditions other than the set conditions, a message "Connecting..." will be displayed at the bottom right of the screen, and the PT will be in standby status until normal connection is established. To change the communications settings, display the System Menu and change the settings.

**Precautions
for Safe Use**

Confirm the safety of the system before turning the power ON and OFF or pressing the reset switch.

Reference If tags are used in the screen data in the NS-series PT, tags will be verified before operation is started. Refer to 6-11 *Verifying Tags* for details.

3-2-2 Starting the PT for the First Time

Always perform the following operations when turning ON the PT for the first time after purchase.

1. Language selection.
2. Set the date and time.

Operate according to the following conditions.

- a) When the power is turned ON to the PT, the following error message will be displayed. Press the **OK** Button.



- b) The System Menu will be displayed. Press the **Initialize** Tab. The dialog boxes and System Menu are set for English-language displays at the factory. The language can be changed to Japanese at this point if desired. To change to Japanese, select it and then press the **Write** Button. The following message will be displayed. Press the **Yes** Button. Do not turn OFF the power supply until the language change process has been completed.

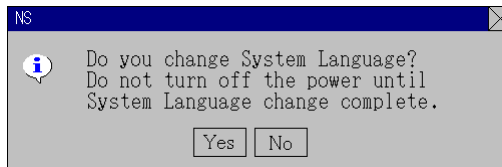

- c) Next, select the **PT Settings** Tab. Set the time and date.

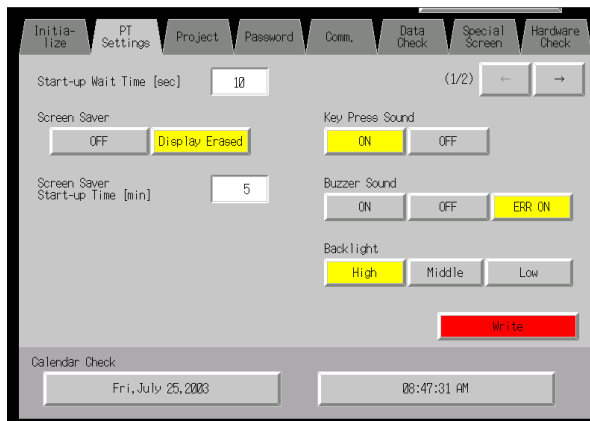

- d) Press the date display area under the heading *Calendar Check*. A dialog box will be displayed. Input the date in yyyy/mm/dd format.

Example: Input March 15, 2002 as **2002.3.15**.

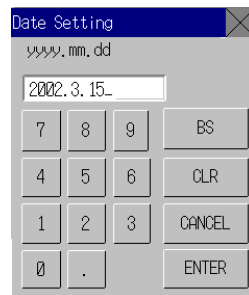

- e) Press the time display area under the heading *Calendar Check*. A dialog box will be displayed. Input the time using a 24-hour clock in hours/minutes/seconds format.
Example: Input 06:01:01 p.m. as **18.1.1**.
The **Write** Button will be displayed, but the time and date settings will be enabled immediately after they have been input in the dialog box.

This completes the procedure required to start the PT for the first time. Now transfer the project data. Refer to 3-6 *Using Memory Cards and Transferring Data to the PT* in the CX-Designer's Online Help.

3-3 Connecting the CX-Designer

Use an RS-232C, Ethernet, or USB cable to connect the PT and computer so that screen data that has been created with the CX-Designer can be transferred to the PT. A modem can also be used.

3-3-1 Connecting via RS-232C or Ethernet

Connect the RS-232C cable from the computer to serial port A or B. The cable can be connected to either serial port A or B, but cables cannot be connected to both ports at the same time. Use either serial port A or B.

To use Ethernet, connect the Ethernet port on the computer to the Ethernet port on the PT.

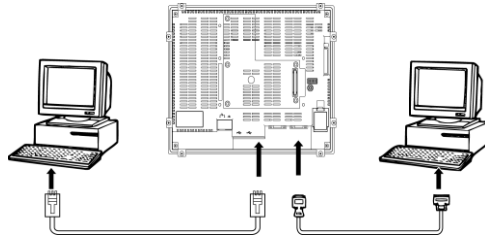

Reference In the following cases, you cannot connect to the CX-Designer using RS-232C.

- Connection is made to both serial ports A and B at the same time.
 - The serial port protocol is set to *Allen-Bradley DF1*.
-

• Communications Conditions

The communications conditions are set with the CX-Server. For details, refer to *Transferring Data to the PT* in the CX-Designer's Online Help.

• Recommended Connecting Cables

The following cables are recommended when connecting via RS-232C.

XW2Z-S002 (OMRON, cable length: 2 m)

(D-Sub male 9-pin and D-Sub female 9-pin, for IBM PC/AT or compatible computers and NX computers in the PC-9800 Series)

For details on preparing connecting cables, refer to *Appendix 5 Preparing Connecting Cables*.

3-3-2 Connecting via USB

Connect the USB port on the computer to the USB slave connector on the PT. Some preparations are required and some restrictions exist, as described below. Be sure to connect USB correctly.

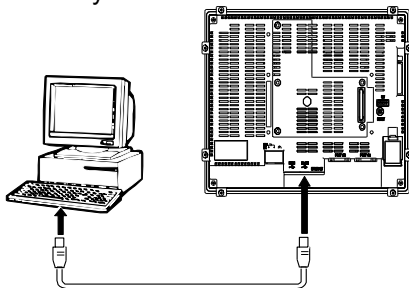

System Program Version

The system program version installed in the PT must be version 6.2 or higher. Update to version 6.2 or higher if the current version is 6.1 or lower.

USB Driver for PTs

To transfer screens using USB communications, a USB driver for the PT must be installed in the computer. For details on installing the USB drivers, refer to *2-2 Installing USB Drivers for NS-series PTs* in the *CX-Designer User's Manual*.

PT Hardware Restrictions

NS-V1 PTs with lot number 0325 (manufactured February 3, 2005) or later support USB data transfers. A commercially available USB cable can be used.

For stable communications, use a USB Cable with a ferrite core attached to it.

The manufacturing date can be checked using the 4-digit or 5-digit lot number given on the back of the PT.

Refer to *NS-series PT Lot Numbers* on page A-8 for information on lot numbers.

Use a USB cable that is 2 m or shorter. If a distance of longer than 2 m is required for a USB connection, use a commercially available USB Hub.

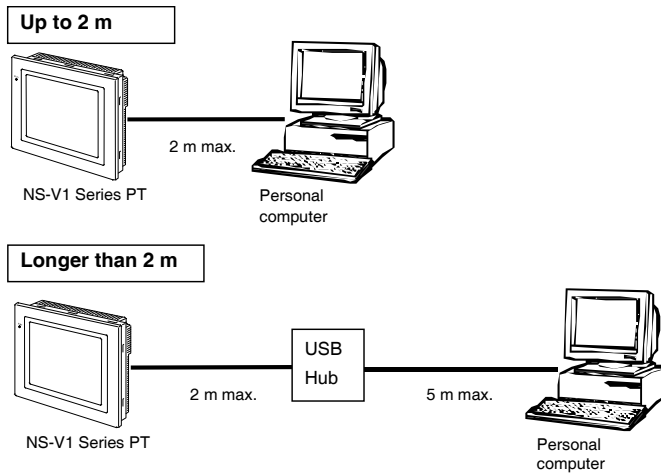

Recommended USB Hubs

Model	Manufacturer
USB-HUB203 (USB 2.0-compatible standard 4-port hub)	Sanwa Supply

Precautions for Safe Use

Commercially available and recommended USB Hubs do not have the same specifications as the NS-series PT. Normal operation may not be possible in environments subject to noise or static electricity. When using USB Hubs, be sure to provide sufficient measures to prevent noise and static electricity, or install in a location that is not subject to noise or static electricity.

Precautions for Correct Use

The USB slave connector on an NS-series PT is used to connect both a personal computer and a PictBridge-compatible printer. (A personal computer is connected to transfer screen data from the CX-Designer.) Do not try to print from the PT when the USB slave connector is connected to a personal computer (i.e., do not turn ON \$SB25, \$SB27, or \$SB29 in system bit memory). The PT or computer may malfunction.

All models in the NS-V2 Series support USB communications. Use a commercially available USB cable to connect the PT to the USB port.

For stable communications, use a USB Cable with a ferrite core attached to it.

Use a USB cable that is 5 m or shorter.

3-3-3 Connecting via a Modem

A modem can be used to connect the computer and a serial port on the PT. For details on connection methods and communications conditions, refer to *Transferring Data to the PT* in the CX-Designer's Online Help.

3-4 Connecting to Bar Code Readers

Connecting a Bar Code Reader to the PT allows bar code data to be read as character strings in the character string input areas.

For details on methods for inputting character strings from a Bar Code Reader, refer to 3-6 *Inputting Numeral and Character Strings in the Programming Manual*.

3-4-1 Connection Methods

Connect the Bar Code Reader to either serial port A or B of the PT as shown in the following diagram.

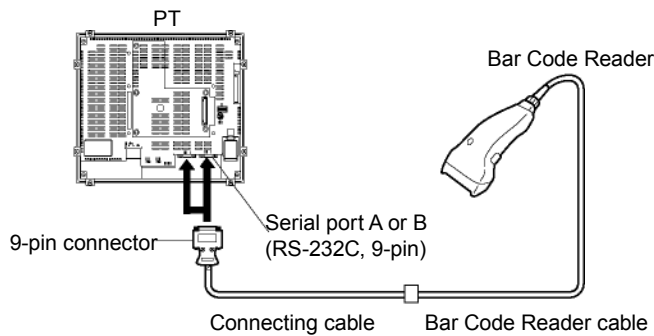

Precautions for Safe Use

Always turn OFF the power to the Bar Code Reader and the PT before connecting or disconnecting cables.

Prepare the connecting cables, referring to *Appendix 7 Preparing Connecting Cables for Bar Code Readers*.

Reference Bar Code Readers cannot be connected to both serial ports A and B at the same time.

3-4-2 Setting Bar Code Readers

The Bar Code Reader's communications conditions and other settings can be set from either the CX-Designer or the PT.

● Setting from the CX-Designer

Use the CX-Designer to set PT settings, such as the conditions for communications with the Bar Code Reader, according to the following table. Set the communications conditions supported by the Bar Code Reader to suit the application environment.

Item	Settings	Default
Data bits	7 or 8 bits	7 bits
Stop bits	1 or 2 bits	2 bits
Parity	None, odd, or even	Even
Communications Speed	4,800, 9,600, or 19,200 bps	9,600 bps
Input method	Manual or Auto	Auto

● Setting from the PT

Set the communications conditions from the System Menu.

For details on specific methods for operating the System Menu, refer to 6-6-6 *Setting Bar Code Readers*.

● Bar Code Reader Settings

Set the settings for the Bar Code Reader according to the following table. Make sure, however, that the communications conditions settings for the communications speed, parity, stop bits, and data bits, match those set for the PT. For details on setting methods, refer to the operation manual of the Bar Code Reader being used.

Item	Settings
Communications Speed	4,800, 9,600, or 19,200 bps
Parity	Even, odd, or none.
Stop bits	1 or 2 bits
Data bits	7 or 8 bits
Preamble	STX
Postamble	ETX
RS/CS control	Invalid
Communications protocol	No protocol mode
Bar code label digit transfer	Transfer prohibited.
ID character transfer	Transfer prohibited.
Bar code types	Multi-read (reads everything)
Trigger switch setting	Automatic read mode

3-4-3 Data Format

Use the following data format for communications using the PT's bar code input function.

STX (02H)	Data	Data		Data	ETX (03H)
--------------	------	------	--	------	--------------

The supported data characters are 20_H to 7F_H hexadecimal and the maximum data length is 254 bytes.

All data that does not follow the specified data format will be discarded as invalid.

3-4-4 Bar Code Input

Use the following procedure to input bar codes using the PT.

1. Touch a Numeral Display & Input or String Display & Input object.
2. The Numeral Display & Input or String Display & Input object will become highlighted.
3. Read the bar code data from the Bar Code Reader.
4. Touch the command button set to either RET (Return) or ENT (Enter) to confirm the input.

For details on the methods for setting Numeral Display & Input, String Display & Input, and Command Button objects, refer to 2-9 *Buttons* and 2-12 *Display and Input Objects* in the *Programming Manual*.

Reference To input bar codes for Numeral Display & Input and String Display & Input objects, select *Other Input Method (command buttons, etc.)* for the input method. When *Other Input Method (command button, etc.)* is selected, the input pad cannot be opened.

3-5 Connecting to Printers

Connecting a printer to the PT makes it possible to obtain hard copy of the contents displayed on the PT screen. Connect printers to the USB connector on the PT. For details on how to obtain hard copy of the PT display, refer to the *Programming Manual* (Cat. No. V073).

NS-series PTs support the following printer standards. The USB connector that is used depends on the printer standard.

Standard	USB connector
ESC/P raster	USB host connector
BJ raster	
PictBridge	USB slave connector

3-5-1 Connecting to a Printer Compatible with ESC/P Raster and BJ Raster

Connect the printer to the USB host connector on a NS15, NS12, NS10, or NS8 PT with a USB cable as shown in the following figure.

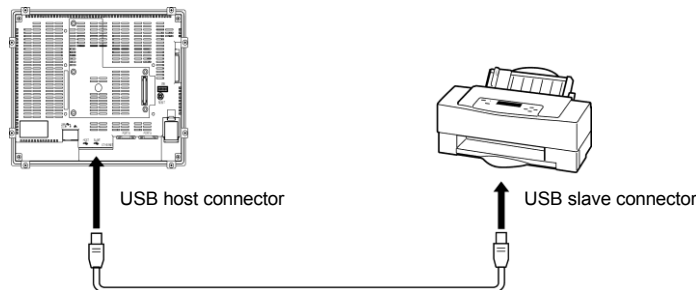

Precautions for Safe Use

- Connecting or disconnecting the cable with power to the printer or the PT turned ON may cause the PT to malfunction. Always turn OFF the power to the printer and the PT before connecting or disconnecting cables.
- Do not connect an USB connector to any device that is not applicable.
- Before connecting an USB connector to a device, make sure that the device is free of damage.
- Printing devices do not have the same general specifications as the PT. Printers may not operate normally in locations subject to noise. When using a printing device, either install it in a location that is not subject to noise or provide shielding.

- Reference**
- Connect the printer directly to the PT with a cable. Connection via a USB hub is not possible.
 - Operation has been verified only for A4-size paper.

Precautions for Correct Use

- Use the following OMRON cables to connect USB devices with an NS-series PT. Using non-OMRON cables may result in incorrect operation.

• Connecting Cables

Use one of the following cables.

NS-US22 (2 m, lock)

NS-US52 (5 m, lock)

• Recommended Printers

Operation checks have been performed for the following printers.

Manufacturer	Model
EPSON (ESC/P raster)	PM-2200C, PM-930C, PM-870C, PM-740C, PM-A970, PM-T990, PM-D870, PM-G720 PX-5500, PX-A720, PX-G5100, PX-G930
CANON (BJ raster)	BJ-M70 PIXUS 550i, 50i, 80i, iP2000, iP3100, iP4100, iP4100R, iP90, iP3300

3-5-2 Connecting a PictBridge-compatible Printer

The NS-series PTs with system version 8.1 or higher (except for NS12/10/8/5-V1 and NS5-□□0□-V2 PTs) support PictBridge-compatible printers. Connect the USB slave connector on the PT to the printer with a USB cable, as shown in the following figure.

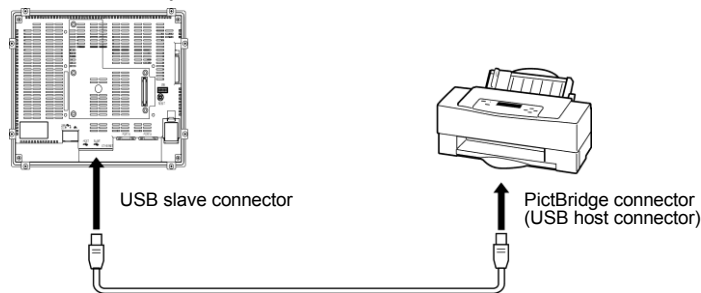

Precautions for Safe Use

- Printing devices do not have the same general specifications as the PT. Printers may not operate normally in locations subject to noise. When using a printing device, either install it in a location that is not subject to noise or provide shielding.
- Do not connect an USB connector to any device that is not applicable.
- Before connecting an USB connector to a device, make sure that the device is free of damage.
- The PT may malfunction if the connecting cable is connected or disconnected while the power supply to the PT is turned ON. Always turn OFF the power supply to the printer and PT before connecting or disconnecting the cable.

- Reference**
- Connect the printer directly to the PT with a cable. Connection via a USB hub is not possible.
 - When printing with PictBridge, noise may affect the quality of the printout due to processing characteristics.
 - Operation has been verified only for A4-size paper.

Precautions for Correct Use

The USB slave connector on an NS-series PT is used to connect both a personal computer and a PictBridge-compatible printer. (A personal computer is connected to transfer screen data from the CX-Designer.) Do not try to print from the PT when the USB slave connector is connected to a personal computer (i.e., do not turn ON \$SB25, \$SB27, or \$SB29 in system bit memory). The PT or computer may malfunction.

• Connecting Cables

Use a commercially available USB cable (2 m max.).

3-5 Connecting to Printers

- **Recommended Printers**

Operation checks have been performed for the following printers.

Manufacturer	Model
EPSON	PM-G4500, PX-G5300, PX-5600, PM-501A, PM-A8405, EP-801A, EP-901A, EP-901F
CANON	PIXUS MX7600 PIXUS MP980, MP630, MP620, MP540, MP480 PIXUS iP4600, iP3600, iP100 PIXUS iP5000 PIXUS Pro9500, Pro9000
HP	Photosmart 8753
KONICA MINOLTA	magicolor 2530DL

Reference An NS-series PT will switch to PictBridge mode when \$B25, \$B27, or \$B29 is turned ON in system bit memory. Depending on the printer, an error message saying that an unsupported digital camera is connected may be displayed. Even if this display appears, you can still print properly by using the bits in system bit memory (\$B25, 27, and 29).

3-6 Using Memory Cards

1. Memory Cards can be used with the PT. History files can be stored in Memory Cards as CSV files. There are four different types of history file, as follows:

Alarm/event history:	Stores alarm/event history data that has been registered by CX-Designer.
Data log:	Stores trend data.
Operation log:	Stores screen operation log data.
Error log:	Stores error history data for when macros are executed.

The history data is normally saved in internal memory that is backed up in the PT, but can also be saved in CSV file format. When history data is saved as a CSV file, it is stored in the Memory Card.

The CSV files containing history data are saved in a user-specified folder in the log folder created in the Memory Card.

2. The following data can be transferred to the Memory Card.
 - System programs (the programs required to operate the PT, such as for communications and fonts)
 - Screen data (data used in the PT display)

There are three methods for transferring data, as follows:

- Automatic download (Transfers data from the Memory Card to the PT.)
- Automatic upload (Transfers data from the PT to the Memory Card.)
- Manual transfer (Direction for data transfer is selected manually.)

Precautions for Correct Use

- Use a Memory Card recommended by OMRON. Incorrect operation may occur if a non-recommended memory card is used.
-

Reference Recommended Memory Card

Model	Memory capacity	Memory type
HMC-EF183	128 Mbytes	Flash memory
HMC-EF283	256 Mbytes	Flash memory
HMC-EF583	512 Mbytes	Flash memory

The Memory Card can be overwritten approximately 100,000 times.
When using the PC card socket in devices such as laptop computers, use the HMC-AP001 Memory Card Adapter.

For details on transferring data with the computer (CX-Designer), refer to *Transferring Data to the PT* in the CX-Designer's Online Help.

3. The data created in Data Block Tables can be saved as CSV files in DBLK folder on a Memory Card.
4. The contents of the PT's internal memory can be saved to Memory Cards using macros. The contents of Memory Cards can also be written to the PT's internal memory.

3-6-1 Installation

NS15

1. Loosen the Memory Card bracket screw shown in the figure below and push the Memory Card firmly into the back of the slot. If inserted in the wrong orientation, the Memory Board will not go all the way in. Do not try to force it in.

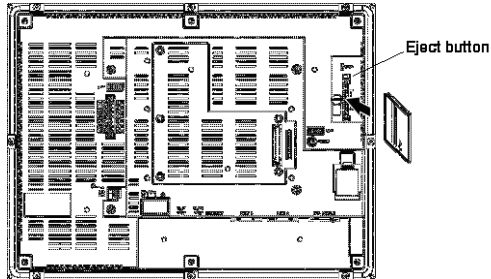

2. Tighten the Memory Card bracket screw.
The tightening torque is 0.6 N·m.

NS12/10/8/5

1. The Memory Card is installed in the memory card interface on the side of the PT.

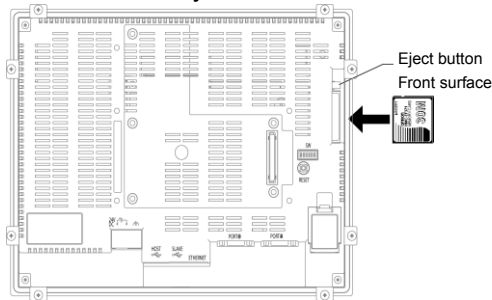

2. Push the Memory Card firmly into the back of the slot. (The eject button will be pushed out when the Memory Card is installed properly.)

• Removing the Memory Card

NS15

Make sure the Memory Card power indicator is OFF. Loosen the Memory Card bracket screw and then press the eject button.

NS12/10/8/5

Press the eject button.

To stop the Memory Card from springing out and falling, place your middle finger on the eject button, and hold the Memory Card with your index finger.

3-6-2 Replacing the System Program

The system program in the PT can be replaced or upgraded to a higher version. There are two methods that can be used to replace the system program.

- Using a recovery/upgrade program
- Transferring system program data

Using a Recovery/Upgrade Program

For details on the recovery/update program, select **Start - Program - OMRON - CX-One - CX-Designer NS Most Recent NS-series PT Update/Recovery Procedure**.

Transferring System Program Data

When System Program Ver. □.□ is selected and loaded with the CX-Designer, it is stored under the CX-Designer's install folder (default location is C:\Program Files\Omron\CX-One\CX-Designer) in folders that are created for each type and version, as follows:

\SystemBackup\NS15\V□_□\bank1:	Ver. □.□ for NS15
\NS12_V1_V2\V□_□\bank1:	Ver. □.□ for NS12
\NS10_V1_V2\V□_□\bank1:	Ver. □.□ for NS10
\NS8_V1_V2\V□_□\bank1:	Ver. □.□ for NS8
\NS5_V1_V2\V□_□\bank1:	Ver. □.□ for NS5

To replace a system program, use Windows Explorer or another method to copy each of the folders for the required system program under \bank1 to the route directory of the Memory Card.

For details on methods for transferring data from the Memory Card to the PT, refer to 3-6-3 *Transferring Data with Memory Cards*.

The system backup folder can be created only if CX-Designer is installed from the stand-alone CD-ROM. If the CX-Designer is installed from CX-One, reinstall the system program by following the procedure for using a recovery/update program described above.

Restrictions on System Program Replacement

Starting the PT may become impossible if the system program replacement procedure is not performed correctly. Observe the following precautions.

- When upgrading the system program (or replacing it with a previous version), use the recovery/update program at least the first time.
- System program version 6.2 or higher must be used to replace the system program in the NS5-SQ0□-V2, NS5-TQ0□-V2, or NS5-MQ0□-V2. If an earlier system program version is used, screens may not be displayed properly. If an earlier version is installed by mistake, use the recovery/update program and upgrade to system program version 6.2 or higher.
- System program version 8.0 or higher must be used to replace the system program in the NS5-SQ1□-V2, NS5-TQ1□-V2, or NS5-MQ1□-V2. Earlier versions cannot be used.
- System program version 8.1 or higher must be used to replace the system program in the NS15-TX01□-V2. You cannot replace the system program with a system program of a lower version.

3-6-3 Transferring Data with Memory Cards

Using a Memory Card with the PT allows system programs (programs that are required to operate the PT, such as those for communications and fonts) and screen data to be transferred to and from the PT.

There are two ways to transfer the data. The data can be transferred using the system menu or by setting the DIP Switch on the back of the NS-series PT.

When screen data is transferred and modified frequently, it is convenient to transfer the data from the System Menu. Use the DIP Switch on the back of the PT instead of the screen operation to save screen data when the display screen is damaged. For details on the System Menu's *Memory Card Transfer* operation, refer to 6-8-9 *Memory Card Transfers*.

This manual focuses on the PT's rear-panel DIP switch settings. Three data-transfer operations can be set on the DIP switch: automatic download (transfers data from the Memory Card to the PT), automatic upload (transfers data from the PT to the Memory Card), or manual transfer (user selects whether to download or upload).

Precautions for Safe Use

- Before transferring data, check that the system programs and screen data types match those in the PT.
- Always reset the PT or turn ON the power again after changing the DIP switch setting.
- Do not perform the following operations while accessing the Memory Card. The data may be damaged and the Memory Card may need to be formatted.
 - Turn OFF the power to the PT.
 - Press the PT reset switch.
 - Remove the Memory Card.
- Do not remove the Memory Card while power is being supplied to it.

If the PT system is damaged due to the power being turned OFF while a file is being written, or other reason, using normal downloading to replace the system programs may not be possible. For details on troubleshooting, refer to page 3-27.

● Data Transfer Security

With NS-series PTs with system program version 6.6 or higher, verification of a security password can be required to transfer data. This password can be used to prevent the project data from being stolen from the PT or overwritten in the PT.

The security password is set from the CX-Designer. Refer to information on transferring the project to the PT in the online help of the CX-Designer for the setting procedure.

● DIP Switch

The Memory Card can be divided into up to four areas, which are called banks. The DIP switch on the rear panel of the PT has six pins. The ON/OFF combination of these pins specifies which transfer method is used.

Precautions for Correct Use

There are two DIP switches on the NS15-TX01□-V2, one for transferring data to and from the Memory Card and one to set RS-232C or RS-422A for serial port B. Refer to 3-11 *SR-232C/RS-422A Selector DIP Switch* for details on setting the serial port B.

Pin No.	Function
1	Specifies bank 1 when transferring. (ON: Specifies bank 1.)
2	Specifies bank 2 when transferring. (ON: Specifies bank 2.)
3	Specifies bank 3 when transferring. (ON: Specifies bank 3.)
4	Specifies bank 4 when transferring. (ON: Specifies bank 4.)
5	Specifies upload or download. (ON: Upload, OFF: Download)
6	Specifies manual or automatic transfer. (ON: Manual, OFF: Automatic)

Banks are automatically created under the following conditions.

- When data is transferred to the Memory Card using the CX-Designer.
- When data is transferred (uploaded) from the PT.

-
- Reference**
- When transferring data, only one bank can be specified. Set only one of pins 1 to 4 to ON.
 - The PT will operate normally when the DIP switch is set to a combination other than one specifying automatic upload, download, or manual transfer.
 - When data has already been stored in the banks of the Memory Card and uploading is executed, the previous data in the specified bank will be deleted. Always check the data stored in the banks before uploading.
 - If the \BANK□\DATA and \BANK□\SYSTEM are created manually in the Memory Card, and used for purposes other than transferring data, when uploading is performed, the data in the folders will be deleted, and the data in the PT will be copied to the folders. Therefore, do not use \BANK□\DATA or \BANK□\SYSTEM when creating folders in the Memory Card.
 - Set all pins to OFF when using the PT for normal operations.
-

Precautions for Safe Use

Use the following technique when changing DIP-switch settings.

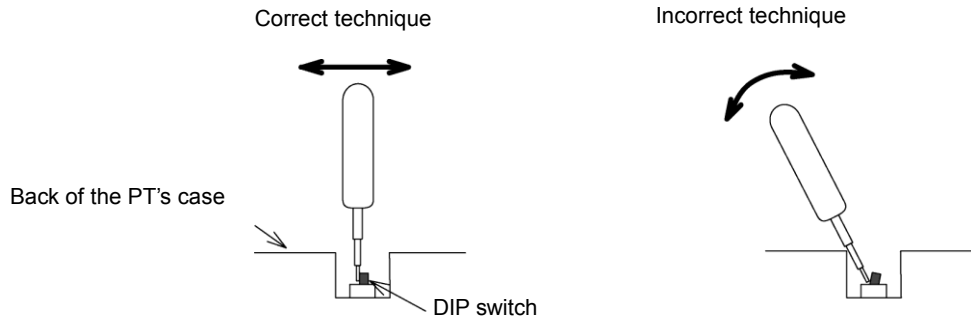

The DIP switch may bend or break if the tool is incorrectly levered against the PT's case as shown in the diagram.

● **Automatic Download**

An automatic download transfers system programs and screen data from the Memory Card to the PT.

Set the DIP switch for automatic download, as shown below.

The Memory Card cannot be used to transfer data when the DIP switch pins are set to combinations other than those specified here.

DIP switch pin and status						Operation
1	2	3	4	5	6	
ON						Automatically downloads bank 1 system programs and screen data.
	OFF	OFF	OFF	OFF	OFF	
	ON					Automatically downloads bank 2 system programs and screen data.
OFF		OFF	OFF	OFF	OFF	
		ON				Automatically downloads bank 3 system programs and screen data.
OFF	OFF		OFF	OFF	OFF	
			ON			Automatically downloads bank 4 system programs and screen data.
OFF	OFF	OFF		OFF	OFF	

3-6 Using Memory Cards

Use the following procedure to automatically download data.

1. Turn OFF the power to the PT.
2. Set the DIP switch.
3. Insert the Memory Card with the specified banks stored in it into the PT.
4. Turn ON the power to the PT.
The system programs and screen data will be written to the PT.
5. The status of the PT indicators during data transfer is as shown below.
Do not remove the Memory Card during data transfer.
Transferring data: Indicator flashes orange.
Transferring completed: Indicator flashes green.
Error occurred: Indicator flashes red.
Refer to page 3-27 if an error occurs.
6. Turn OFF the power.
7. Remove the Memory Card.
8. Turn OFF all the DIP switch pins.
9. Turn ON the power.

A warning message will not be displayed when automatic download is executed even if the PT model, version, and language for the system programs and screen data that are stored in the PT are different from those that are stored in the Memory Card.

Always check carefully that the PT model and Memory Card details match before transferring data automatically.

When data transfer security has been set for the project data stored in the PT to protect the project data from unauthorized data transfers, an automatic download will not be performed. To download the data, use the manual transfer procedure described in *Manual Transfer*, below.

- Automatic Upload

An automatic upload transfers system programs and screen data from the PT to the Memory Card.

Set the DIP switch for automatic upload, as shown below.

The Memory Card cannot be used to transfer data when the DIP switch pins are set to combinations other than those specified here.

DIP switch pin and status						Operation
1	2	3	4	5	6	
ON				ON		Automatically uploads system programs and screen data to bank 1.
	OFF	OFF	OFF		OFF	
	ON			ON		Automatically uploads system programs and screen data to bank 2.
OFF		OFF	OFF		OFF	
		ON		ON		Automatically uploads system programs and screen data to bank 3.
OFF	OFF		OFF		OFF	
			ON	ON		Automatically uploads system programs and screen data to bank 4.
OFF	OFF	OFF			OFF	

Use the following procedure to automatically upload data.

1. Turn OFF the power to the PT.
2. Set the DIP switch.
3. Insert the Memory Card into the PT.
4. Turn ON the power to the PT.
The system programs and screen data will be written to the Memory Card.

5. The status of the PT indicator during data transfer is as shown below.
Do not remove the Memory Card during data transfer.
Transferring data: Indicator flashes orange.
Transferring completed: Indicator flashes green.
Error occurred: Indicator flashes red.
Refer to page 3-27 if an error occurs.
6. Turn OFF the power.
7. Remove the Memory Card.
8. Turn OFF all the DIP switch pins.
9. Turn ON the power.

A warning message will not be displayed when automatic upload is executed even if the PT model, version, and language for the system programs and screen data that are stored in the PT are different from those that are stored in the Memory Card.

Always check carefully that the PT model and Memory Card details match before transferring data automatically.

When data transfer security has been set for the project data stored in the PT to protect the project data from unauthorized data transfers, an automatic upload will not be performed. To upload the data, use the manual transfer procedure described in *Manual Transfer*, below.

• **Manual Transfer**

Use screen operations to select the direction (download or upload), contents (Project, Project & System, or System), and banks.

Use one of the following procedures to manually transfer data.

1. Turn OFF the power to the PT, turn ON pin 6 of the DIP switch, and turn ON the power to the PT.

DIP switch pin and status						Operation
1	2	3	4	5	6	
					ON	Enables manually downloading or uploading the system program and screen data.
OFF	OFF	OFF	OFF	OFF		

2. Execute *Memory Card Transfer* from the *Special Screen Tab Page* of the System Menu. Refer to 6-8-9 *Memory Card Transfers* for details.

Use the following procedure to manually transfer data mentioned above in step 1.

1. Turn OFF the power to the PT.
2. Turn ON pin 6 of the DIP switch.
3. Insert the Memory Card into the PT.
4. Turn ON the power.
5. The following screen will be displayed on the PT.

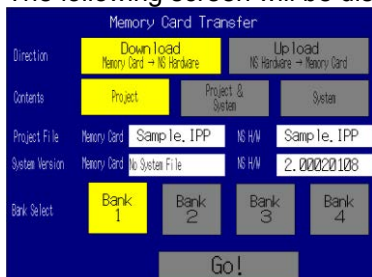

6. Specify the direction of the transfer (download or upload), the transfer contents (project, project and system program, or system program), and bank. The IPP file name and system version that are stored in both the specified bank of the Memory Card and the PT will be displayed in the Project File and System Version fields. After confirming the details, press the **Go** Button.

3-6 Using Memory Cards

- When data transfer security has been set for the project data stored in the PT to protect the project data from unauthorized data transfers, the following password-entry screen will be displayed. Input the password and press the **ENTER** Button.



- A message confirming the transfer will be displayed. Press the **OK** Button to execute the specified data transfer operation. When downloading, the screen data previously stored in the PT will be deleted. Also, specify whether or not to delete the log data.

**Precautions
for Correct Use**

Always clear the log data for the following.

- When changing settings related to alarms, events, or the data logs.
 - When transferring a different project to the PT.
-

- A warning message will be displayed if the PT model, system program/screen data versions, or language stored in the PT do not match the corresponding data stored in the Memory Card. Press the **Yes** Button to continue transferring the data.
- The uploading/downloading screen will be displayed while data is being transferred. A screen indicating that the transfer has completed will be displayed when the transfer has finished. (If an error occurs, a transfer error screen will be displayed. Refer to *Errors* on page 3-28 if an error occurs.)
- The indicator will flash green when transferring has finished.
- Turn OFF pin 6 of the DIP switch and reset the PT.

A warning message is not displayed at the PT when the PT model, version, and language are different if the system programs used are version 1.0□.

Therefore, if the wrong data is downloaded, execute the transfer operation again using automatic download.

The system settings cannot be changed for the upload operation.

• Errors

- During Automatic Transfer
The indicator on the front panel will flash red if an error occurs during data transfer. Check the following items if an error occurs.
 - Is the Memory Card inserted into the PT?
 - Do the banks set with the DIP switch exist in the Memory Card?
(During Download)
 - Is the size of the transfer data greater than the free space in the PT or Memory Card?

Check these items before transferring data again.

Reference An error message will not be displayed if an error occurs.

• During Manual Transfer

If an error occurs during data transfer, a transfer error screen will be displayed.

Check the following items for each message displayed.

Error Messages Requiring Checking

Error message	Check item
Memory Card Error Could not recognize a Memory Card. Check the Memory Card and reset the NS Hardware.	<ul style="list-style-type: none"> • Is the Memory Card inserted into the PT? • Is the Memory Card damaged?
Project Transmission Error Transmission Failed. Check the Memory Card and reset the NS Hardware.	<ul style="list-style-type: none"> • Was the Memory Card removed during data transfer? • Is the free space on the Memory Card insufficient? • Is the Memory Card damaged?
System Transmission Error Transmission Failed. Check the Memory Card and reset the NS Hardware.	<ul style="list-style-type: none"> • Does the screen data volume exceed the memory capacity of the PT?
Cannot find source data. Are you sure to continue Downloading/Uploading?	<ul style="list-style-type: none"> • Does the transfer source directory or file exist? (Note: If the Yes Button is pressed and data is transferred, the previous data at the transfer destination will be deleted.)
The password is incorrect. Check the password. Reset the PT.	<ul style="list-style-type: none"> • Check whether the password is correct.

After checking the message, reset the PT, and transfer the data again.

• System Program Recovery/Update

It may not be possible to replace the system program using a normal download if the PT system has been damaged, e.g., if the power was turned OFF while a file was being written. Use the following procedure to operate the PT if system program replacement is not possible or the system program is damaged and the PT does not start.

Select **Programs – Omron - CX-One - CX-Designer - Most Recent NS-series PT Update/Recovery Program** from the Windows Start Menu.

3-7 Installing the Video Input Unit

A Video Input Unit (NS-CA001 or NS-CA002) can be mounted to an NS-series PT. Mounting a Video Input Unit allows images from a video camera or vision sensor to be displayed on the PT screen. This section explains how to connect a Video Input Unit to the PT with a cable using the NS-CA001 as an example.

A Video Input Unit can be connected to the NS8, NS10, NS12 or NS15 (except that the NS-CA001 cannot be connected to the NS15. Also, the NS15 does not support video input from the NS-CA002, but it does support analog RGB input from the NS-CA002). A Video Input Unit cannot be connected to the NS5.

Reference Refer to the *NS Series RGB and Video Input Unit Operation Manual* (Cat. No. V086) for information on NS-CA002 installation methods.

3-7-1 Video Input Unit Components

The following table shows the Video Input Unit's product configuration.

Model	Components	
	Name	Contents
NS-CA001 Video Input Unit	Video Board (1)	Allows video input.
	Cover (1)	Protects Video Board.
	Cable (1)	Connects the PT's functional ground terminal and the cover to prevent noise.
	Screw (M3) (9)	These screws are used for the following: <ul style="list-style-type: none"> • Securing the Video Board to the back of the PT. • Securing the cover to the back of the PT. • Attaching the cable to the cover.
	Instruction sheet	Instruction sheet for NS-CA001.

Precautions for Safe Use

To comply with EC Directives when mounting the Video Input Unit on the PT, attach the PT to a control panel that has been cut to fit the size. (Refer to 3-1-3 *Mounting the PT to the Control Panel* for panel cutout dimensions.)

3-7-2 Nomenclature and Functions

Familiarize yourself with the nomenclature and functions of the Video Board before using the Video Input Unit.

Video Board: Front View

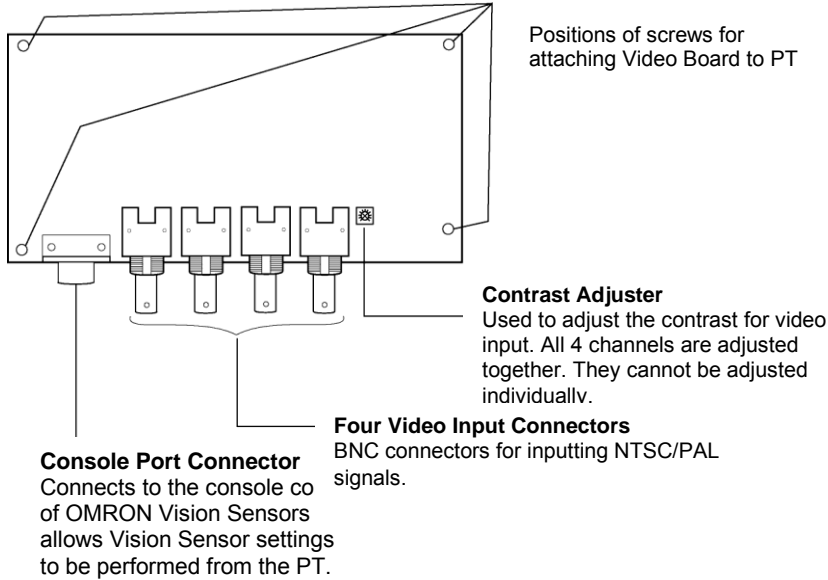

Video Board: Rear View

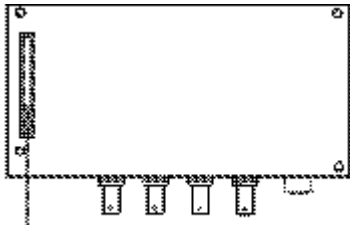

Expansion Interface Connector
Connects to the PT's expansion interface connector when mounting the Video Board.

Precautions for Correct Use

The NS-series PTs support video input for standard NTSC and PAL signals. Display may not be possible, however, if the input signal deviates from the standard signal. Before operation, be sure to check the output signal of the camera to be used. If display cannot be made, take measures so that the input signal is a standard signal.

Video Input Specifications

Item	Specifications
Input system	NTSC (RS-170A compliant) or PAL
Scanning system (See note.)	Interlaced
Input signal	1.0 V p-p 75 Ω
Signal input connector	BNC connector

Note: The NS-series PTs do not support progressive scanning (i.e., non-interlaced scanning).

3-7-3 Installation Method for Video Input Unit

This section describes the method for mounting the Video Input Unit to the PT.

A Video Input Unit can be connected to the NS8, NS10, NS12 or NS15 (except that the NS-CA001 cannot be connected to the NS15. Also, the NS15 does not support video input from the NS-CA002, but it does support analog RGB input from the NS-CA002). A Video Input Unit cannot be connected to the NS5.

Precautions for Safe Use

- Do not touch the surface of the substrate or mounted devices with your bare hands. Also, discharge static electricity from your body in advance.
- After mounting the Video Input Unit to the PT, all fittings must be tightened with the provided screws. Tighten the screws to a torque of 0.6 N·m.
- Always turn OFF the power to PT before mounting or removing the Unit. Follow the procedures and install the Unit correctly.
- When the Video Input Unit is installed, the depth of the PT will increase by 24 mm.
To install the Video Input Unit, secure sufficient space inside the control panel beforehand.

● Installing the Video Input Unit

1. Mount the Video Board onto the back of the PT so that its expansion interface connector is inserted into the expansion interface connector on the back of the PT and the respective screw holes are aligned. Hold the Video Board by the corners keeping it parallel to back of the PT.

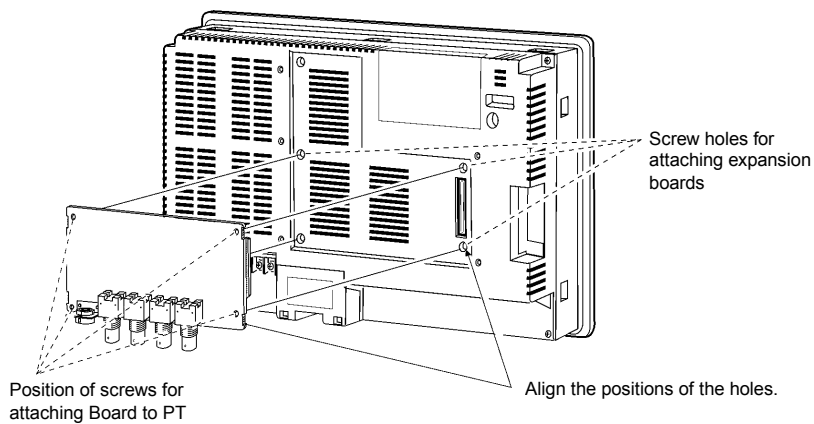

Push firmly on the connector end of the board to ensure that it is inserted sufficiently.

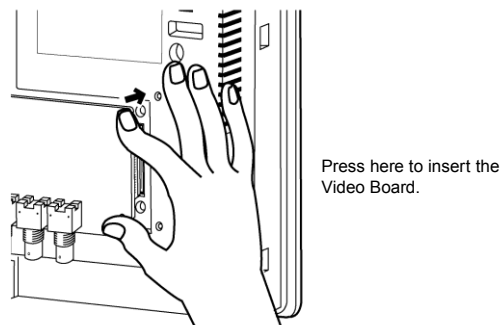

2. Secure the four corners of the Video Board with screws.

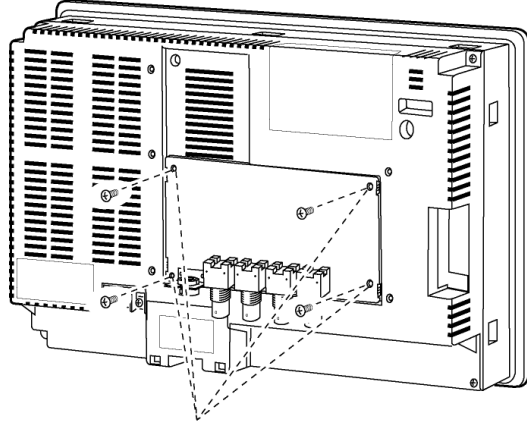

Secure these four places with screws.

3. Insert screws in the screw holes for attaching the cover and tighten them slightly.

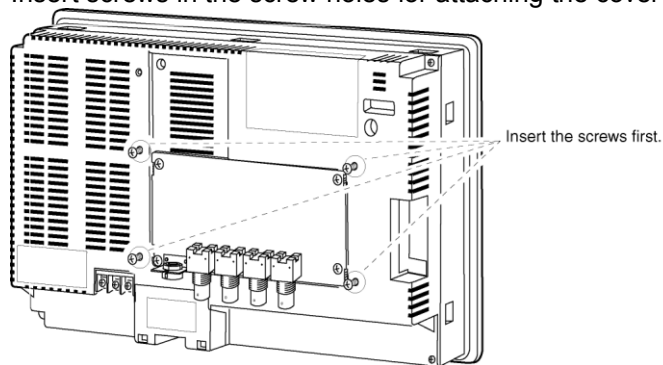

Align the cover's screw holes with the screws and mount the cover.

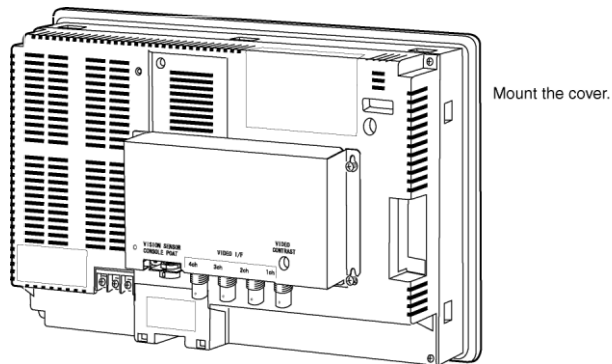

3-7 Installing the Video Input Unit

Slide the cover downward and tighten the screws.

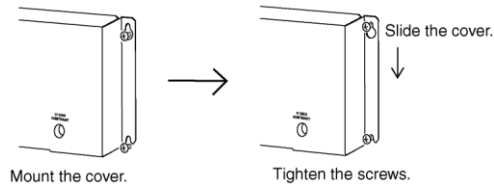

● Connecting the Cable

Connect the functional ground terminal of the PT and the cover with the cable to prevent malfunction due to noise.

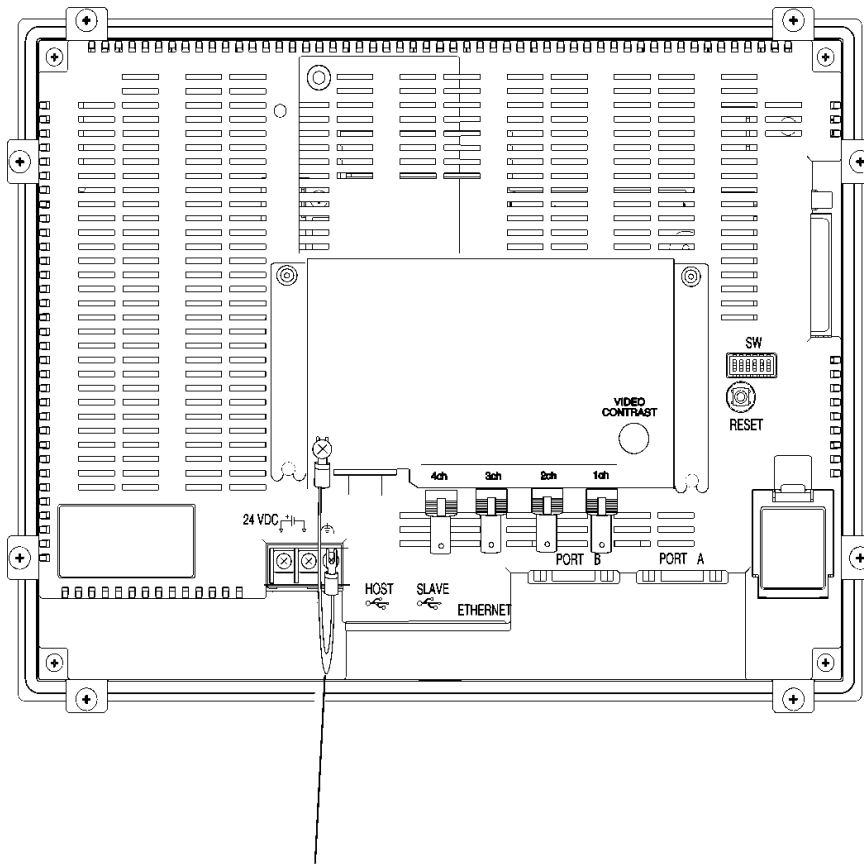

Connect with the cable provided.

● **Removing the Video Input Unit**

1. Remove the cover from the PT as follows:
Loosen the screws.

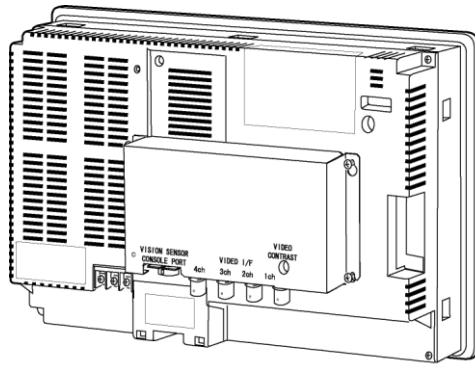

Lift up on the cover and remove it.

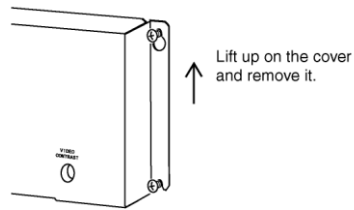

2. Remove the screws from the four corners.

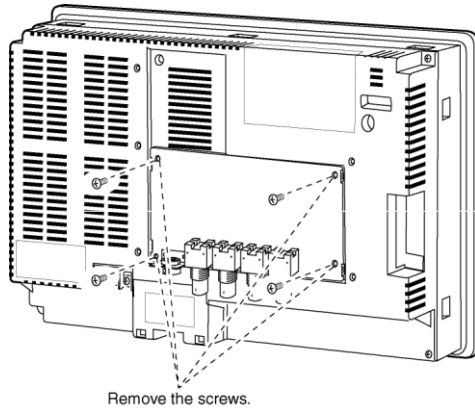

3-7 Installing the Video Input Unit

3. Remove the Video Board from the expansion interface connector of PT. Follow the procedure shown below.

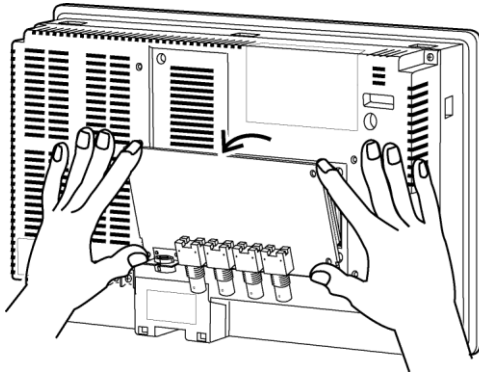

Remove the upper side of the Video Board first, holding the four corners.

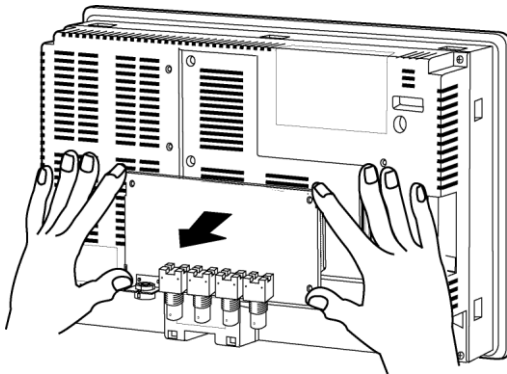

Then, pull out the entire Video Board.

3-7-4 Connecting to Video Input Connectors

Use the following method to connect cameras to the Video Input Unit mounted to the PT.

**Precautions
for Safe Use**

Do not pull on the cables or bend the cables beyond their natural limit.
Do not place heavy objects on top of the cables or other wiring lines. Doing so may break the cables.

● Connecting to Video Input Connectors

1. Insert the BNC socket on the camera's video output cable into a video input connector.

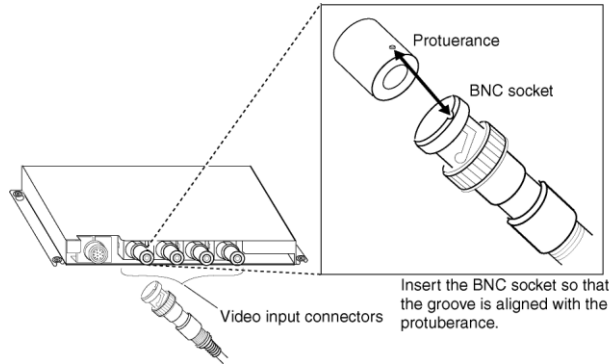

2. After inserting the BNC socket, twist it clockwise until it locks into place.

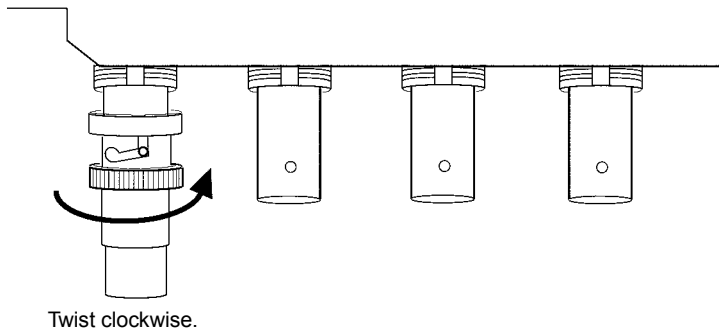

● Removing the Video Input Connector

1. Unlock the BNC socket on the camera's video output cable by twisting it counterclockwise while pushing it.

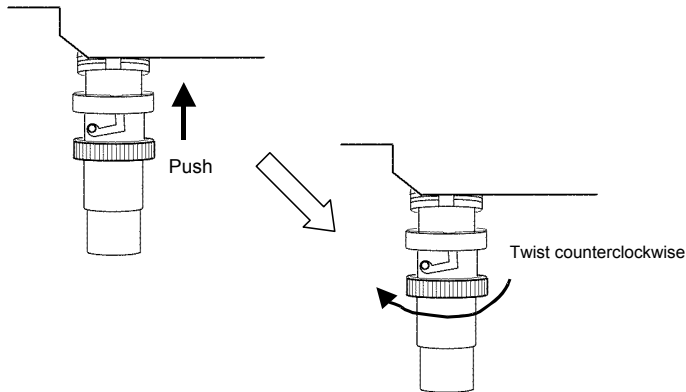

2. After unlocking the BNC socket, pull it out.

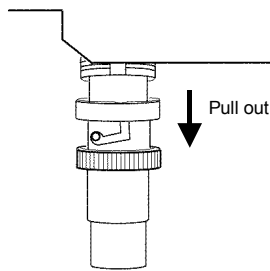

If the camera's video output cable uses an RCA plug, connect it to the video input connector using a BNC-RCA connector in the way shown below.

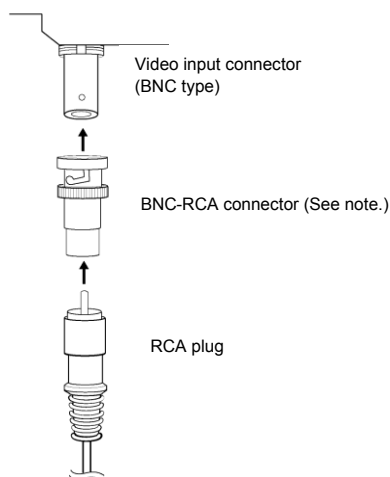

Note A BNC-RCA connector is provided with the Monitor Cable (F150-VM) for OMRON Vision Sensors. It is not provided with the Video Input Unit (NS-CA001).

● **Connecting to the Console Port Connector**

Use the following method to connect the Video Board's console port connector to the console connector of an OMRON Vision Sensor (F150-C10V3, F160-C10, F180-C10, F400-C10V2, F250-C10, V530-R150V2).

1. Insert the socket of the Relay Cable (F150-VKP; see note) into the Video Board's console port connector.

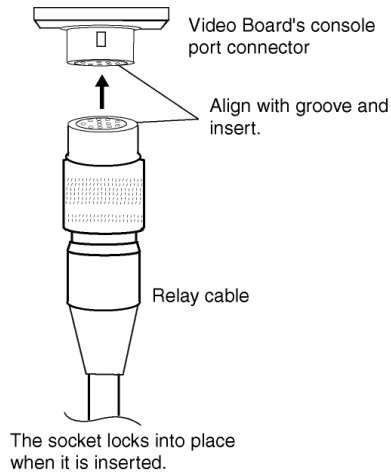

Note The Relay Cable (F150-VKP) is the cable used to connect the Video Board's console connector to the console connector of an OMRON Vision Sensor.

● **Removing the Console Port Connector**

Use the following method to remove the Relay Cable from the Video Board's console port connector.

1. Remove the Relay Cable by pulling on the connector as shown below.

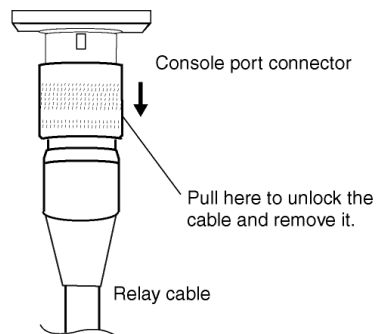

3-7 Installing the Video Input Unit

● Setting the Contrast

If the picture displayed on the PT screen is too bright or dark, contrast adjustment is required. Contrast adjustment is usually performed using one of the following procedures.

- Select *Video Configuration* from the Special Screen Tab Page in the System Menu. (Refer to *Video Configuration* under 2-20 *Special Functions* in the *NS-series Programmable Terminals Programming Manual*.)
- Select the *Contrast Adjustment* function for Command Buttons. (Refer to *Command Buttons* under 2-9 *Buttons* in the *NS-series Programmable Terminals Programming Manual*.)

If the contrast is not improved using the above methods, change the contrast with the Video Board's contrast adjuster using the following method.

Turn the contrast adjuster gradually using a small screwdriver while checking the picture displayed on the PT screen.

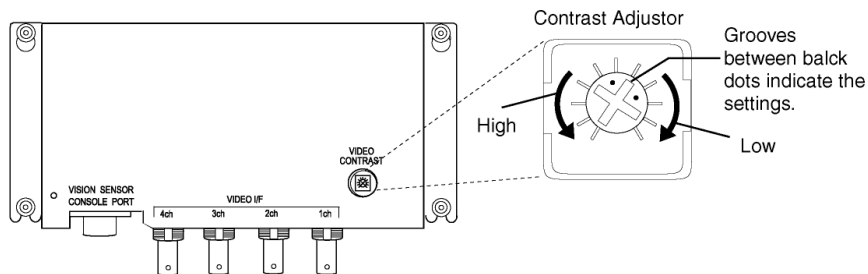

If turning the contrast adjuster too much, the image may be distorted. Turn the contrast adjuster in the opposite direction to remove the noise.

● **Grounding Precaution**

Either ground the Camera, PT, and PLC at only one point, or connect the grounds for each with a special line. Some computers internally connect the SG terminal to the RS-232C and USB connector hoods. If such a computer is connected to the PT or PLC and there is a ground potential difference between the Camera and the PT/PLC, an overcurrent may flow through the electronic components inside the NS-CA001 or NS-CA002 as shown in the following figure, possibly damaging the NS-CA001 or NS-CA002.

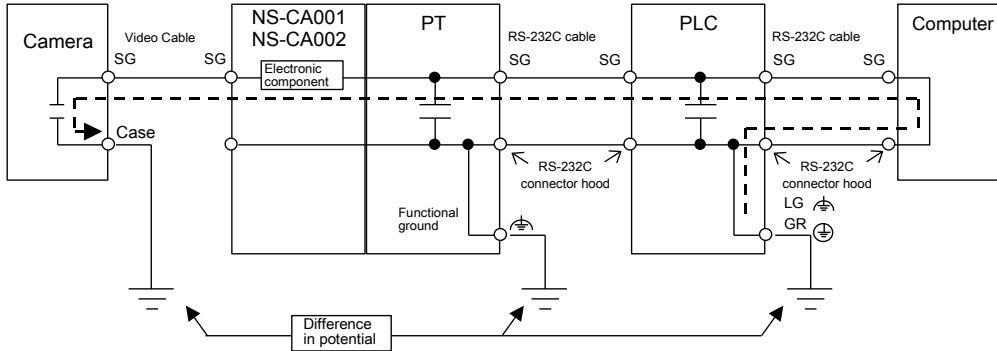

*The example in the above figure shows a computer connected to an RS-232C connector on the PLC.

● **Recommended Connections**

Ground to only one point as shown in the following figure or use equivalent wiring so that there is no difference in ground potential.

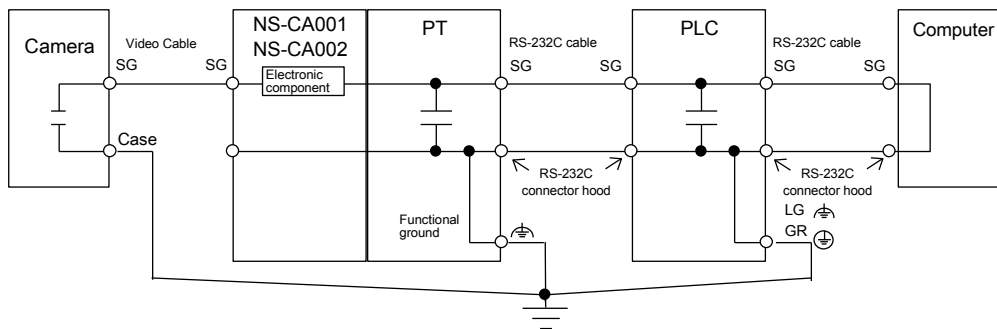

3-8 Installing the Controller Link Interface Unit

This section describes the method for installing and wiring the Controller Link Interface Unit, which can be mounted to an NS10, NS12, or NS15 PT. The Controller Link Interface Unit cannot be mounted to an NS8 or NS5 PT.

3-8-1 Controller Link Interface Unit Components

The following table shows the Controller Link Interface Unit's product configuration.

Model	Components	
	Name	Contents
NS-CLK21 Controller Link Interface Unit	NS-CLK001 Connector Conversion Board (1)	Used for mounting the Controller Link Support Board to the PT.
	NS-CLK01 Controller Link Support Board (1)	Connects the PT to the Controller Link Network.
	Connector (1)	Connects the communications cable and Controller Link Support Board.
	Cover (1)	Protects the connector and the Controller Link Support Board.
	Cable (1)	Connects the cover and the PT's functional ground terminal to prevent noise.
	Screw (M3) (10)	These screws are used for: <ul style="list-style-type: none"> • Securing the Connector Conversion Board to the back of the PT. • Securing the cover to the back of the PT. • Attaching the cable to the cover.
	Instruction sheet	Instruction sheet for NS-CLK21

Reference NS-CLK21 Units with lot number 12Y2 or later (manufactured on November 12, 2002 or later) comply with EC Directives.

Precautions for Safe Use

To comply with EC Directives when mounting the Controller Link Interface Unit on the PT, attach the PT to a control panel that has been cut to fit to size. (Refer to 3-1-3 *Mounting the PT to the Control Panel* for cutout dimensions.)

3-8-2 Nomenclature and Functions

Familiarize yourself with the nomenclature and functions of the Controller Link Support Board before operation.

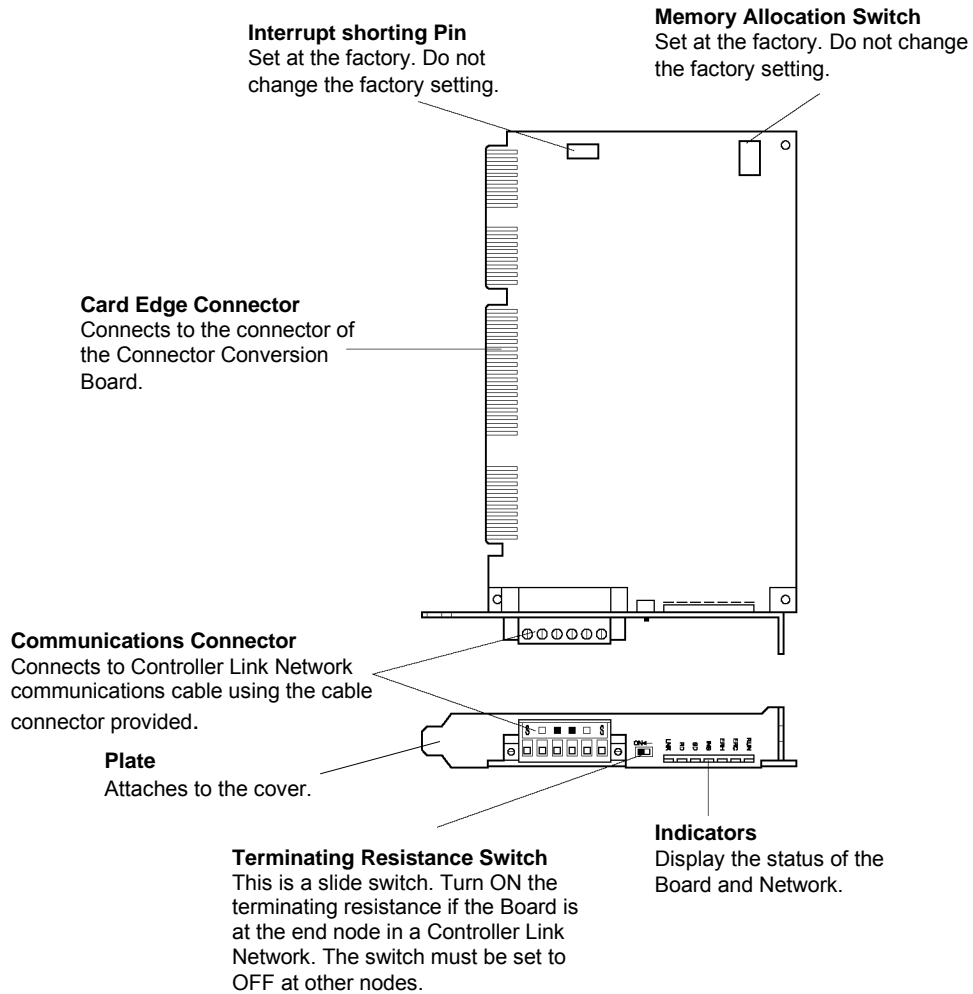

Reference	To identify nonconforming Controller Link Boards, check the Model printed on the Plate. This will tell you whether it conforms with EC Directives. Model 3G8F5-CLK21: Does not conform with EC Directives Model NS-CLK01: Conforms with EC Directives
------------------	---

● Indicators

Indicator	Name	Color	status	Meaning
RUN	Operating	Green	Lit	Normal operation.
			Not lit	A Board operating error (watchdog timer error) occurred.
ERC	Communications error	Red	Lit	One of the following errors occurred. <ul style="list-style-type: none"> • Communications error • Same node address used twice (i.e., address duplication error) • Hardware error
			Not lit	Normal operation
ERH	EEPROM error	Red	Lit	One of the following errors occurred. <ul style="list-style-type: none"> • EEPROM error • EEPROM data link table error • EEPROM routing table error • EEPROM network parameter error
			Not lit	No EEPROM error.
INS	Network participation	Yellow	Lit	The Board is participating in the network.
			Not lit	The Board is not participating in the network.
SD	Send	Yellow	Lit	Sending data.
			Not lit	Not sending data.
RD	Receive	Yellow	Lit	Receiving data.
			Not lit	Not receiving data.
LNK	Data link	Yellow	Lit	Participating in data link.
			Flash-ing	Error in data link table setting.
			Not lit	Not participating in data link or data link inactive.

● **Switch Settings**

The following settings are made at the factory. Do not change these settings.

Item	Switch	Setting
Memory address	Memory allocation switch	SW1: ON SW2: ON SW3: OFF SW4: ON
Interrupt level	Interrupt shorting pin	Set to IRQ10.

● **Setting Terminating Resistance**

Turn the built-in terminating resistance ON or OFF using the terminating resistance switch (slide switch). Terminating resistance is required at the both ends of a wired network to absorb unnecessary signals and reduce the noise. The Controller Link Support Board has built-in terminating resistance, which can be connected simply by setting the slide switch to ON.

Set the switch to ON to connect the terminating resistance at both end nodes in wired networks and set the switch to OFF at all other nodes.



Setting	Terminating resistance
OFF (factory setting)	Not connected
ON	Connected

Precautions for Safe Use

This switch can be set after the Controller Link Interface Unit is installed on the PT.
Turn OFF the power of the PT before changing the setting.

Reference This switch is set to OFF by default (terminating resistance disconnected).

3-8-3 Installation Method for Controller Link Interface Unit

This section explains the method for mounting a Controller Link Interface Unit to the PT. The Controller Link Interface Unit can be mounted to NS15, NS12 and NS10 PTs only. It cannot be mounted to an NS8 or NS5 PT.

**Precautions
for Safe Use**

- Do not touch the surface of the substrate or mounted devices with your bare hands. Also, discharge static electricity from your body in advance.
 - After mounting the Controller Link Interface Unit to the PT, all fittings must be tightened with the provided screws. Tighten the screws to a torque of 0.6 N·m.
 - Always turn OFF the power to PT before mounting or removing the Unit. Follow the procedures and install the Unit correctly.
 - When the Controller Link Interface Unit is installed, the depth of the PT will increase by 35 mm.
 - To install the Controller Link Interface Unit, secure sufficient space inside the control panel beforehand.
-

● Connecting and Disconnecting

1. Mount the Connector Conversion Board onto the back of the PT so that its expansion interface connector is inserted into the expansion interface connector on the back of the PT and the respective screw holes are aligned. Hold the Board by the corners keeping it parallel to back of the PT.

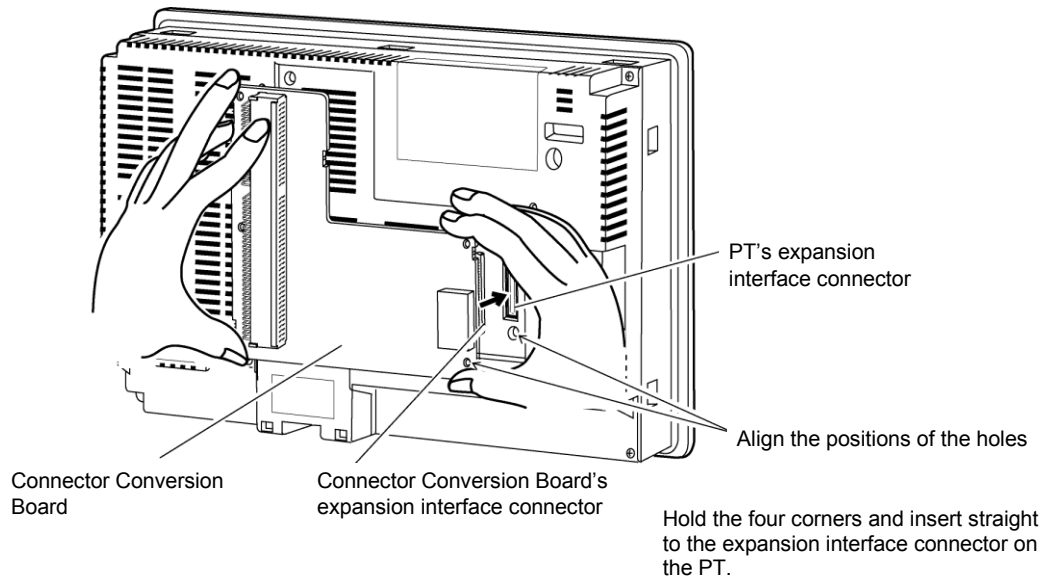

2. Secure the four corners of the Connector Conversion Board with screws.

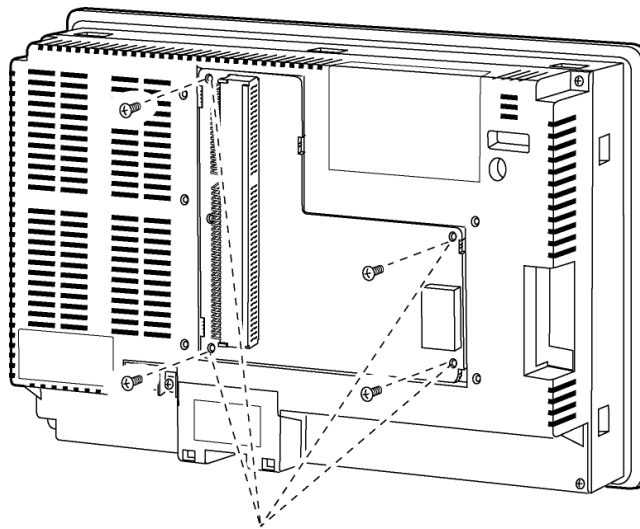

3-8 Installing the Controller Link Interface Unit

3. Insert the Controller Link Support Board's card edge connector into the Connector Conversion Board's connector.

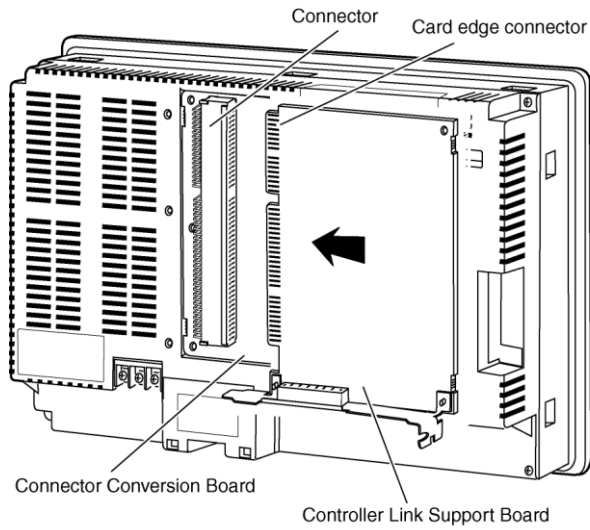

Reference Follow the steps given below if it is hard to insert the card edge connector to the connector on the connector conversion board.

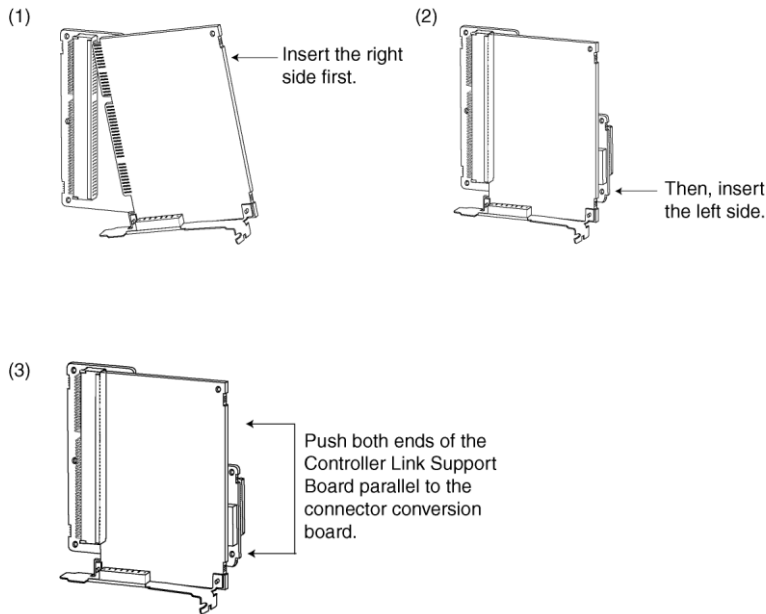

4. Mount the cover to the PT.

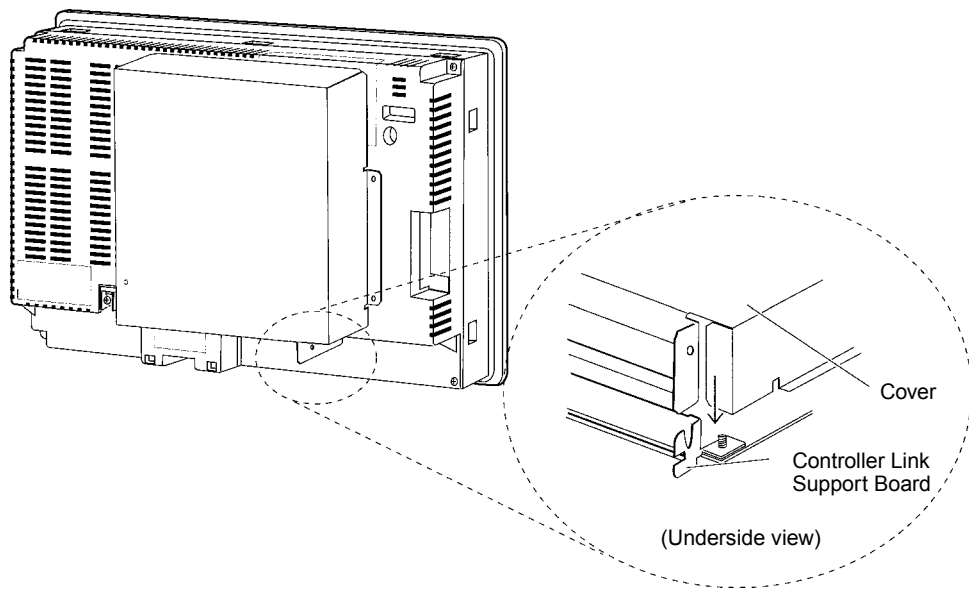

5. Secure the five places shown below with screws.

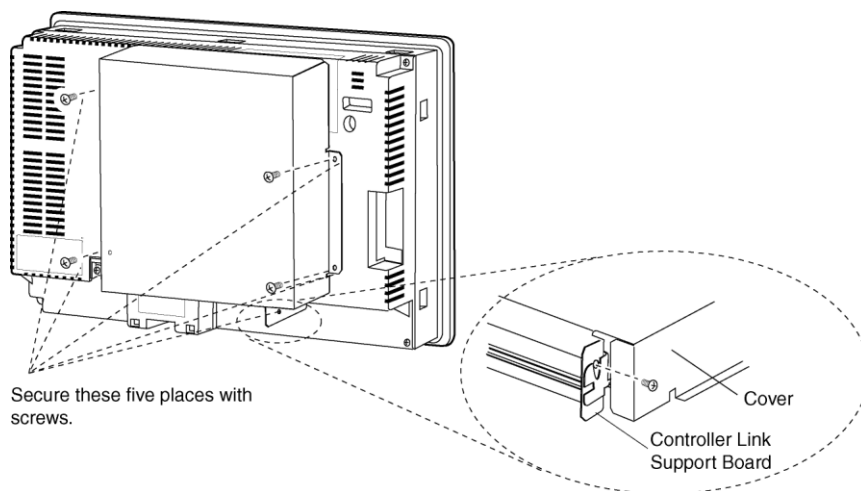

3-8 Installing the Controller Link Interface Unit

● Connecting the Cable

Connect the functional ground terminal of the PT and the cover with the cable to prevent malfunction due to noise.

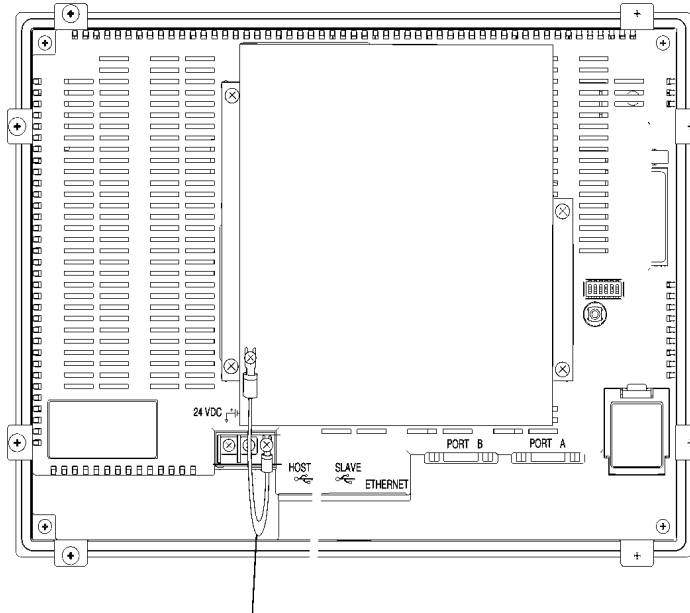

Connect with the cable provided.

● Removing Controller Link Interface Unit

1. Remove the cover.

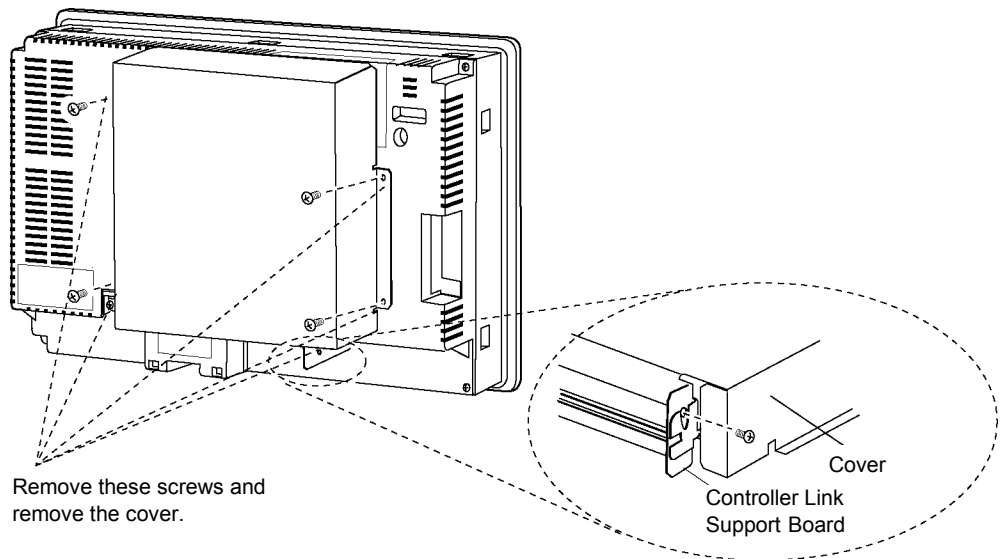

Remove these screws and remove the cover.

3-8 Installing the Controller Link Interface Unit

2. Disconnect the Controller Link Support Board from the connector conversion board. Hold both ends of the Controller Link Support Board and pull out straight.

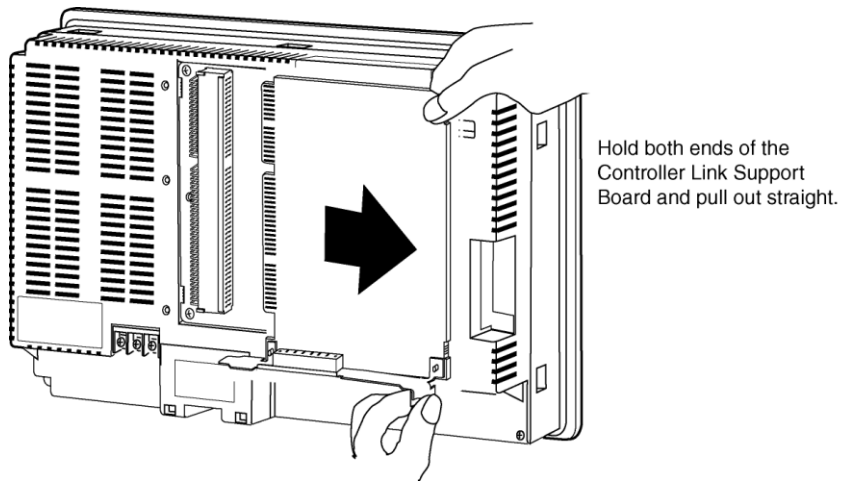

3. Remove the screws from the Connector Conversion Board.

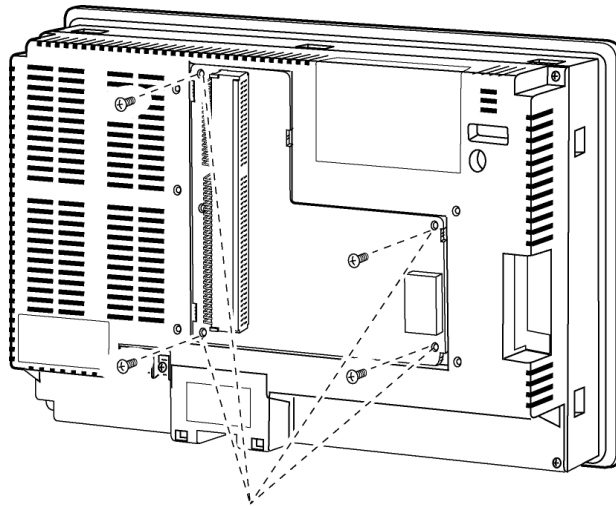

3-8 Installing the Controller Link Interface Unit

4. Disconnect the Connector Conversion Board from the PT. To do this, follow the steps given below.

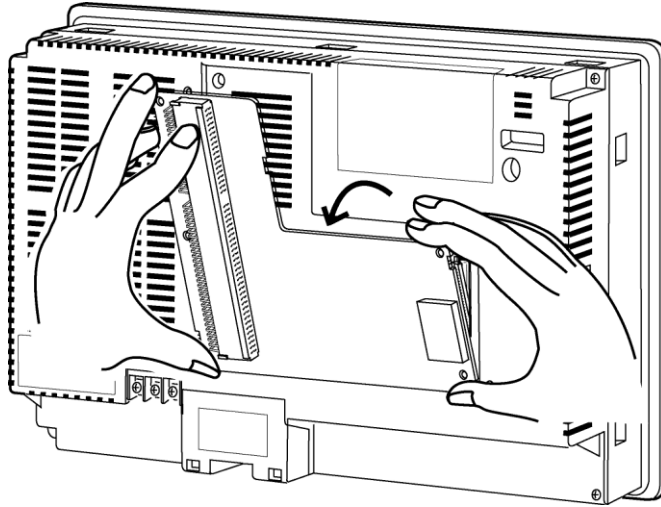

Hold the four corners of the Board and detach upper side first.

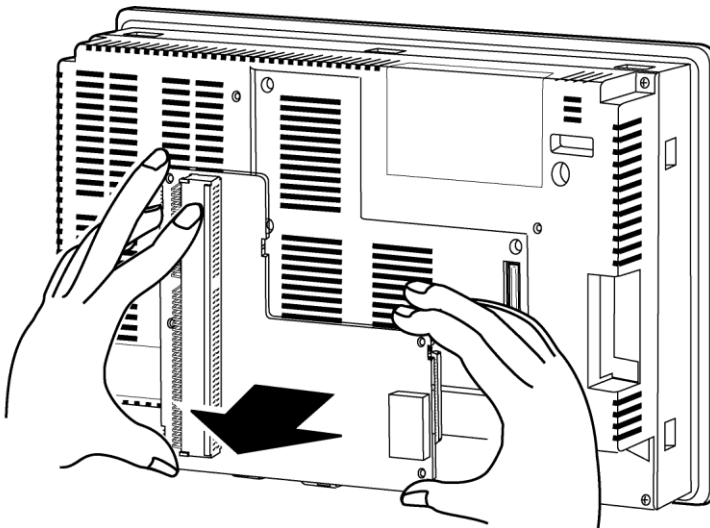

Then, pull out the Board completely.

3-8-4 Wiring

This section describes the method for wiring the network communications cable to the Controller Link Support Board.

● Wiring the Communications Cable

Wire the communications cable to connect identical signals.

Precautions for Safe Use

- Use the cable specified for the communications cable.
- Keep communications cables separated from power lines or high-tension lines to prevent influences from electronic noise.
- Ground the shield of the communications cable at one end of the network. Do not ground the shield at both ends.
- Do not connect the shield cable of the communications cable to a ground that is also being used for power-system devices, such as inverters.
- Do not run wiring outdoors. If outdoor wiring is necessary, take protective measures against lightening, such as underground wiring or wiring inside pipes.
- Always turn OFF the power to PT before connecting the communications cable or installing/removing the connector.
- Use the connector attached to the Controller Link Support Board.

Connecting the Communications Cable

Connect the communications cable to the Controller Link Support Board after first connecting it to the cable connector provided.

Use one of the twisted-pair cables listed below as the communications cable.

Model	Manufacturer	Remarks
Li2Y-FCY2x0.56qmm	KROMBERG & SHUBERT, Department KOMTEC	German company
1x2xAWG-20PE+Tr. CUSN+PVC	DRAKA CABLES INDUSTRIAL	Spanish company
#9207	BELDEN	American company
ESVC0.5x2C	Bando Densen Co.	Japanese company
ESNC0.5x2C-99-087B	Nihon Electric Wire & Cable Co.	Japanese company

Precautions for Safe Use

- Use the cables listed above.
- Normal communications may not be possible if a communications cable other than those listed above is used.

Reference • Terminals for the same signal on the Controller Link Support Board's connector are connected internally.

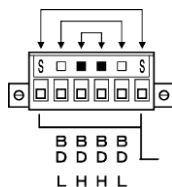

- The thickness of the ground wire connected to the Controller Link Support Board's connector must be less than 2.5 mm².
- Connect to the network using the special connector provided with the Controller Link Interface Unit.

3-8 Installing the Controller Link Interface Unit

Precautions for Safe Use

- The minimum length of the communications cable between nodes is 1 m. Prepare the communications cables at a length of 1 m or longer.
- Use the multidrop method for connecting nodes. Normal communications will not be possible with T branches.

Ground all of the shield lines (including the shield line for the node at only one end of the network) in the way shown below.

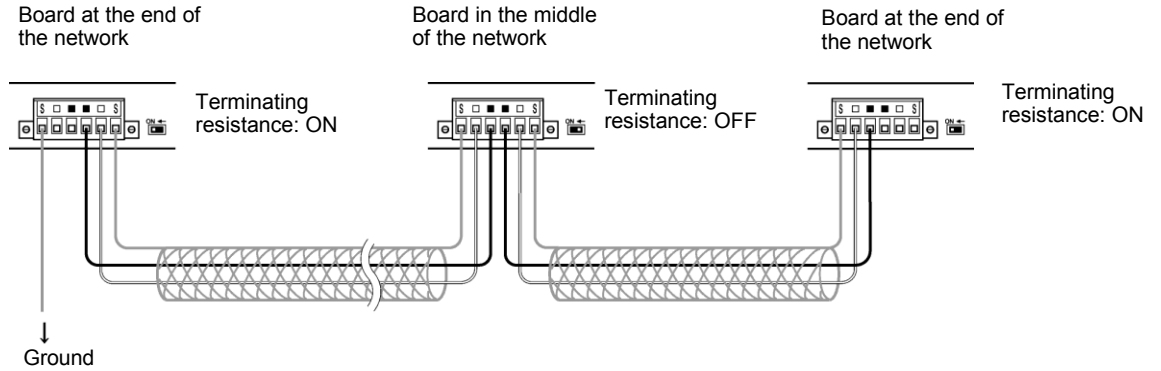

Reference • Terminals of the same type are connected internally. They can thus be connected to either the right or left half of the end Boards.

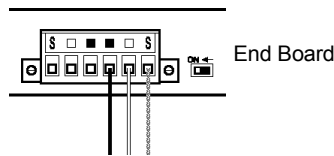

● Connecting Cables to Communications Connectors

When connecting a communications cable to a Controller Link Support Board, connect the cable to the attached connector first and then attach to the connector to the Board.

Connect the communications cable to the connector using the following procedure.

1. Taking care not to damage the mesh of the shield, strip about 50 mm off the end of the cable. Do not strip the cable too far because it may cause a short-circuit.

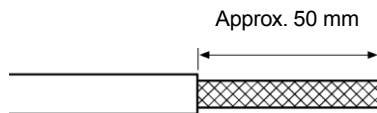

- At the end connected to the node, twist the mesh of the shield into a single wire. Leave sufficient length at the tip of the twisted shield to be connected to a crimp terminal and cover the remaining section with heat-shrink tubing. Cut all the shield mesh off at the end not connected to the node.

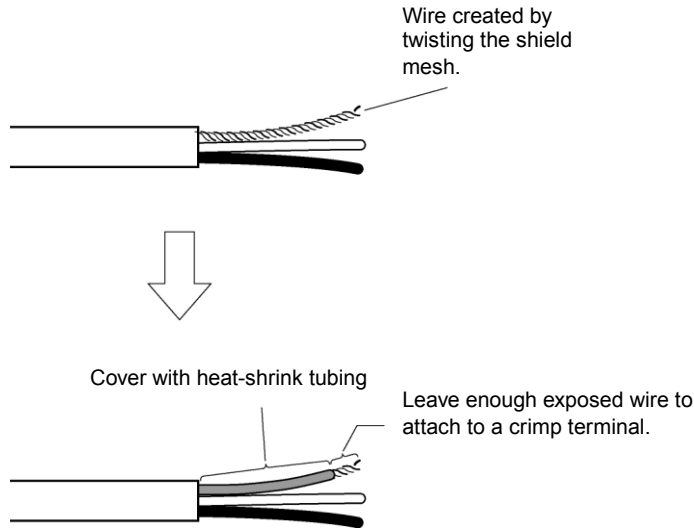

- Strip the ends of the signal wires far enough to attach to the crimp terminals. Twist the wire strands together.



- Cover the end of the cable at the point it was stripped to in step 1 with vinyl tape or heat-shrink tubing.

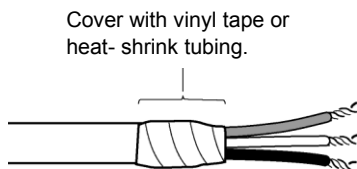

- Attach crimp terminals to the shield wire and signal wires. Cover the connections with vinyl tape or heat-shrink tubing.

Reference • We recommend the Phoenix AI-series crimp terminals shown in the following diagram. Phoenix's ZA3 crimping tool can be used to attach these terminals.



Insert the wire and crimp the terminal to the wire.

3-8 Installing the Controller Link Interface Unit

- Carefully insert the signal and shield lines into the respective holes of the connector (identified with the markings). Ensure that the connector is oriented correctly. The following example is for connection to a Board in the middle of the network.

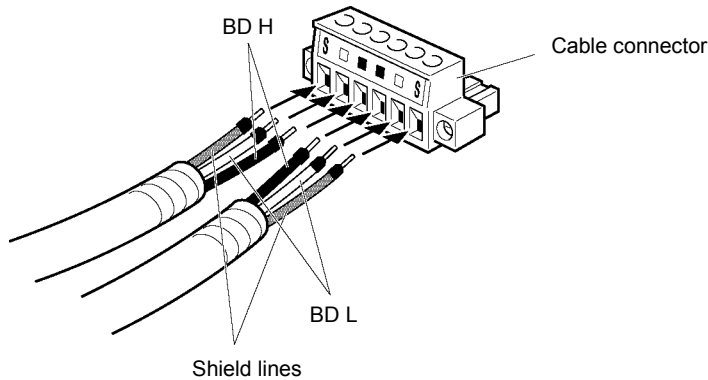

Precautions for Safe Use

- Loosen the screws in the connector enough to allow the terminal to pass before inserting the signal line. If the screw is not loosened, the signal line will go completely into the connector and you will not be able to secure the line.
- Attach crimp terminals to the wires. Never connect bare power supply wires directly to the connector.

- Reference**
- Marks are provided on the connector for the signal lines. Connect the signal lines according to the marks.

Marking	Signal name	Line color
■	BD H (communications data high)	Black
□	BD L (communication data low)	White
S	SHLD (shield)	—

- Marks indicate signals as listed above.
- The lines can be connected to either the right or left half of the connector at the node on either end of the network.
- If grounding by node, the connection method for the shield is different.

Refer to *Wiring Communications Cable* and *Connecting the Shield Line to the Connector* under 3-8-4 *Wiring*, for details on connecting the shield to the connector.

- Firmly secure each signal line with the signal line screws in the connector. An ordinary flat-blade screwdriver with a tip that tapers at the end is not suitable because it cannot be inserted far enough. Use a small flat-blade screwdriver with a uniform width. The applicable tightening torque is 0.2 N·m.

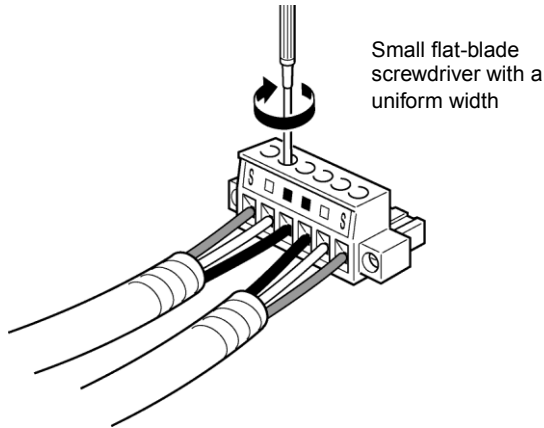

Reference The following screwdriver is available from OMRON.
Model XW4Z-00C

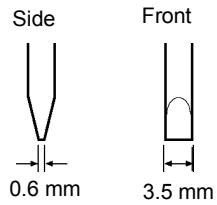

● Connecting the Connector to the Board

Connect the connector on the communications cable to the connector on the Board using the following procedure.

1. Insert the connector on the communications cable into the connector on the Board as shown below.

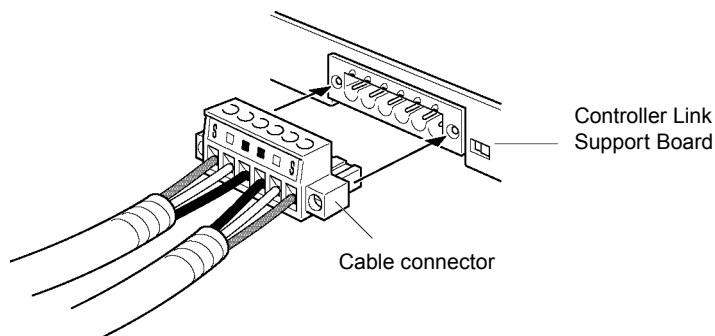

2. Secure the connector to the Board by tightening the screws on the connector. The applicable tightening torque is 0.2 N·m.

**Precautions
for Safe Use**

- If the connector becomes disconnected, not only will the Board be unable to perform communications with other nodes in the network, the network will be split into two at the point of disconnection. Take the utmost care to ensure that the connector does not become disconnected during communications.

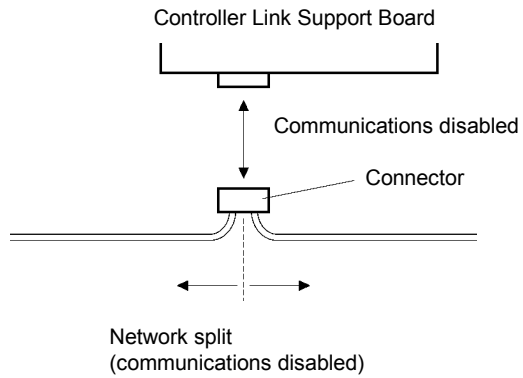

- Do not pull on the communications cable.
- When bending the communications cable, allow 60 mm or more for the bending radius (R).

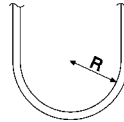

- Do not place heavy objects on the communications cable.
- Supply power only after checking the wiring thoroughly.
- Always tighten the screws of connector after connecting the communications cable.

3-9 Connecting a Monitor

To display images from the PT on a monitor, connect a VGA cable from the monitor to the analog RGB output connector on the NS-series PT. Only the NS15 can output images to an external monitor.

Item	Specification
Monitor resolution	XGA: 1024×768
Monitor response frequency	Horizontal: 48.4 kHz Vertical: 60 Hz
VGA cable length	10 m or shorter

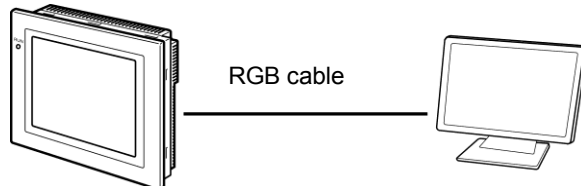

Precautions for Correct Use

- The monitor does not have the same specifications as the PT. The monitor may not operate correctly environments where there is noise, depending on the monitor installation conditions, the length of the VGA cable, and the wiring conditions. When installing a monitor, take sufficient measures to shield against noise or install it where noise is not generated.
- The image may be offset or distorted depending on the specific monitor that you use.
- If the monitor is installed more than 10 m from the PT or if the image is distorted by the wiring conditions, use an analog RGB booster or an analog RGB signal extender.
- If the quality of the pictures displayed on the computer monitor is poor, adjust the picture quality at the monitor, either automatically or manually.

3-10 External Brightness Adjustment

Connect a variable resistor to the external brightness adjustment connector on an NS15 PT with a lot number of 30114 or earlier to externally adjust the brightness of the backlight in the touch panel. This allows the brightness to be set lower than the *Low* selection in the backlight brightness settings (*High, Medium, and Low*) under the operating settings for NS-series PTs. Brightness can be adjusted externally only with the NS15.

Item	Specification
Recommended re-sistance range	0 kΩ to 50 kΩ
Recommended resistive load power	0.1 W
Recommended cable	AWG (10 to 26); 2 m max.

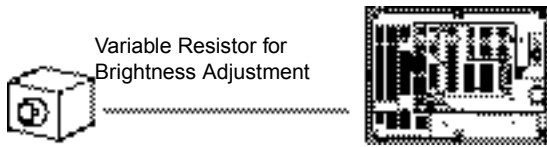

Reference The brightness of models with lot number 1020 (February 10, 2010) or later can be set to a wider range including lower values than previous lots.

Resistance of variable resistor (kΩ)	Brightness (cd/m ²)	
	Lot No. 1020 or earlier	Lot No. 1020 or later
0	400	400
5	380	380
10	330	330
15	290	290
20	200	200
25	110	170
30	60	130
35	20	60
40	15	20
45	15	5
50	15	5

Refer to *NS-series PT Lot Numbers* on page A-8 for information on lot numbers.

3-11 RS-232C/RS-422A Selector DIP Switch

A DIP switch on the NS15 can be used to select RS-232C or RS-422A for serial port B communications. Use the software program to see which cable is selected and use the System Menu to display the status of the connection.

Pin	Specification
1	OFF: Terminating resistance disconnected, ON: Terminating resistance connected
2	OFF: RS-422A (Four-wire), ON: RS-485 (Two-wire)
3	OFF: RS-422A (Four-wire), ON: RS-485 (Two-wire)
4	OFF: Normal transmission, ON: CS control
5	Not used.
6	OFF: RS-232C, ON: RS-422A/RS-485

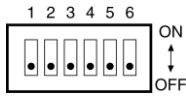

Note: All pins are set to OFF in the factory settings.

Precautions for Correct Use

- There are two connectors that can be used for serial port B, an isolated RS-422A connector and an RS-232C connector. They cannot be used at the same time. Set the DIP switch pins for the serial port B setting to specify the port that is to be used.
- When using RS-422A communications, use the RS-422A connector included with the PT for the isolated RS-422A serial port B connector.

3-11 RS-232C/RS-422A Selector DIP Switch

Section 4

Connecting the Host to Serial Port

This section describes the methods for connecting the host to the serial port of the PT.

For details on connecting through host link communications, refer to the *Host Connection Manual (Host Link)*. For details on Temperature Controller connections and Memory Link communications, refer to the *Host Connection Manual (Temp. Control, MemLink)*. For details on connecting to another company's PLC, refer to the *Host Connection Manual (Multivendor Connection)*.

4-1	1:1 Host Connection	4-2
4-1-1	Connection Methods.....	4-2
4-1-2	Unit Setting Methods.....	4-4
4-2	1:N Host Connection	4-7
4-2-1	Connection Methods.....	4-7
4-2-2	Unit Setting Methods.....	4-7
4-3	High-speed 1:N NT Link	4-18
4-3-1	Unit Setting Methods.....	4-19
4-4	Recommended Connector Cables	4-27

4-1 1:1 Host Connection

4-1-1 Connection Methods

This section describes the methods for connecting the host to serial port A or B of the PT using RS-232C or RS-422A communications. The connection methods are as follows:

- **Direct Connection using RS-232C**
This is the easiest connection method. OMRON cables with connectors can be used, depending on the host being connected.

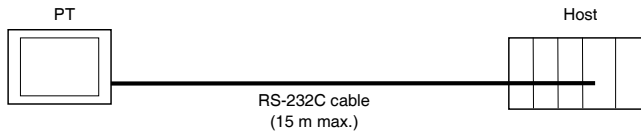

- **A 1:1 Connection using RS-422A and an NS-AL002 or NT-AL001 RS-232C/RS-422A Converter**
This connection method allows an extended communications distance of up to 500 m. *1

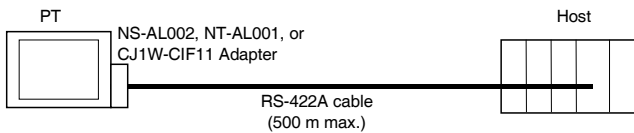

*1: The maximum transmission distance is 50 m when using the CJ1W-CIF11.

The NS-series PTs have two serial ports that can be used simultaneously. Therefore, two hosts can be connected at the same time. Any combination of devices can be connected to the PT.

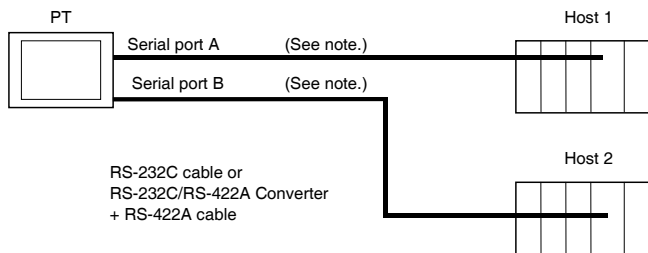

Note: Each port allows 1:N connection. NS-AL002 connects either serial A or serial B, but not both due to structural restrictions.

- **RS-422A Connection (NS15 Only)**

If the RS-232C/RS-422A selector is used to select RS-422A, RS-422A communications can be performed on serial port B.

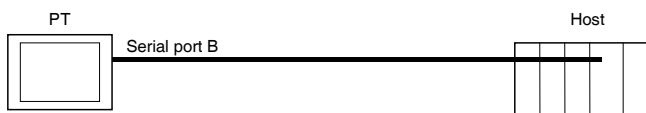

Precautions for Safe Use

- Always tighten the connector screws after connecting communications cables.
- Do not pull on the cables or bend the cables beyond their natural limit. Do not place heavy objects on top of the cables or other wiring lines. Doing so may break the cables.

• Supported RS-232C Host Units

Some models and series of OMRON PLCs have a built-in 1:1 NT Link function. Some PLCs can also be connected in a 1:1 NT Link by adding a Serial Communications Board or Communications Board.

When connecting the PT to a PLC, check the series and model of the PLC and the model of the Board mounted to the PLC.

Refer to *Appendix 8 Standard Models* for details on the Units that can be connected to NS-series PTs as hosts using RS-232C or RS-422A communications in a 1:1 NT Link.

Reference CS/CJ series CPU Units cannot be connected in a 1:1 NT Link. Use a 1:1 connection through 1:N NT Links (normal or high speed). For details, refer to *1:N NT Links* or *High-speed 1:N NT Links* in *Section 4-2 1:N Host Connection*.

• Supported RS-422A Host Units

Units for RS-422A communications with a built-in 1:1 NT Link function vary according to the type and series of OMRON PLC used.

- C200HX/HG/HE(-Z) PLCs can be connected in a 1:1 NT Link for RS-422A by adding a Communications Board.
- CQM1H PLCs can be connected in a 1:1 NT Link for RS-422A by adding a Serial Communications Board.

Check the series and type of the PLC and the model of the Board that is mounted to the PLC when connecting the PT to the host.

Refer to *Appendix 8 Standard Models* for details on the Units that can be connected to NS-series PTs as hosts and support a 1:1 NT Link using RS-422A.

Reference The 1:1 NT Link is not supported for RS-485 (two-wire) communications. Always use RS-422A (four-wire). NS-series RS-485 (two-wire) communications are used to connect to an OMRON Temperature Controller. The NS-AL002 cannot be used with the NT-series PTs or PLCs.

• Connecting to CPM2C PLCs

The CPM2C has a single connector that is the same shape as a CS-series peripheral port. Internally, the connector has signal lines that are for use with the CPU's built-in RS-232C port and the peripheral port. Therefore, when using the CPM2C, use the settings for the CPU's built-in RS-232C port or for the peripheral port according to the converter cable and port used. When using a CPM2C1-CIF21 Simplified Communications Unit, connect it to the RS-232C port. Use CS1W-CN118 Connecting Cable to connect the CPM2C to the NS-series PT using the built-in RS-232C port of the CPM2C. The peripheral port cannot be used to connect the PT.

Refer to the *CPM2C Operation Manual* (Cat. No. W356) for details.

Port for connecting PT	PLC Setup
CS1W-CN118 port (D-Sub 9-pin)	Set for built-in RS-232C.

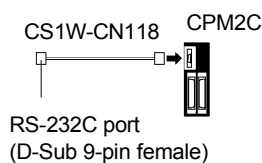

4-1 1:1 Host Connection

- **Connecting to Simplified Communications Units**

When using a CPM2C1-CIF21 Simplified Communications Unit, connect it to the RS-232C port.

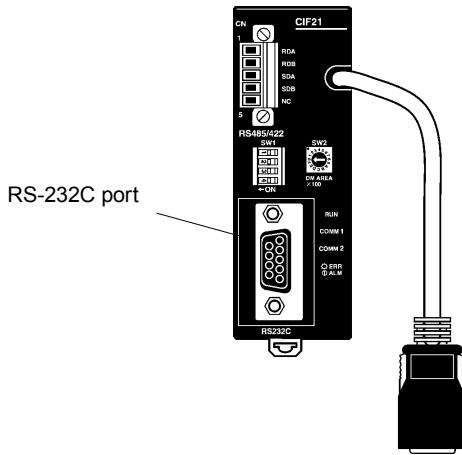

4-1-2 Unit Setting Methods

- **Host Settings**

The methods for setting each Unit are as follows:

Connecting C Series, C200HS, C200HX/HG/HE(-Z), CQM1, CPM2A, CPM2C, CQM1H PLCs, or CVM1/CV Series(-V□)

- **PLC Setup Area**

Write the settings directly from the Programming Device (CX-Programmer, etc.) to the PLC Setup Area (in DM Area) according to the host type and port used.

Using RS-232C

Host type	Address	Write value	Settings
Built-in RS-232C port of C200HS, C200HX/HG/HE(-Z), CPM1A, CPM2A, CPM2C, CQM1, or CQM1H	DM 6645	4000	Uses 1:1 NT Link
Port A of C200HX/HG/HE(-Z) (See note 1.) Port 1 of CQM1H (See note 2.)	DM 6555		
Port B of C200HX/HG/HE(-Z) (See note 1.)	DM 6550		

- Note 1. RS-232C port of Communications Board.
2. RS-232C port of Serial Communications Board.

Using RS-422A

Host type	Address	Write value	Settings
Port A of C200HX/HG/HE(-Z) (See note 1.)	DM 6555	4000	Uses 1:1 NT Link
Port 2 of CQM1H (See note 2.)	DM 6550		

- Note 1. RS-422A port of Communications Board.
2. RS-422A port of Serial Communications Board.

Refer to the manuals of the PLC being used for details on using the PLC Setup Area.

• **Setting the Front Panel DIP Switch**

Using RS-232C

When using C200HX/HG/HE(-Z), CQM1, or CQM1H PLCs, set the DIP switch on the front panel to enable the PLC Setup Area (Data Memory) settings, as follows:

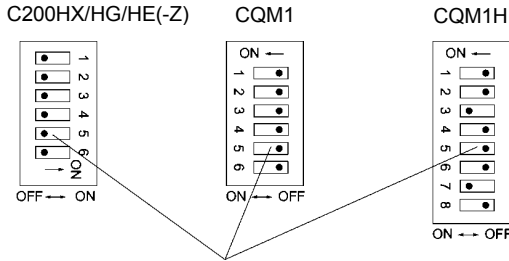

RS-232C Communications Conditions Setting
Set pin 5 of the DIP switch to OFF to enable the PLC Setup Area settings.

• **Setting the CPM2A Front Panel DIP Switch**

When using a CPM2A, set the DIP switch on the front panel to enable the PLC Setup Area (Data Memory) settings, as follows:

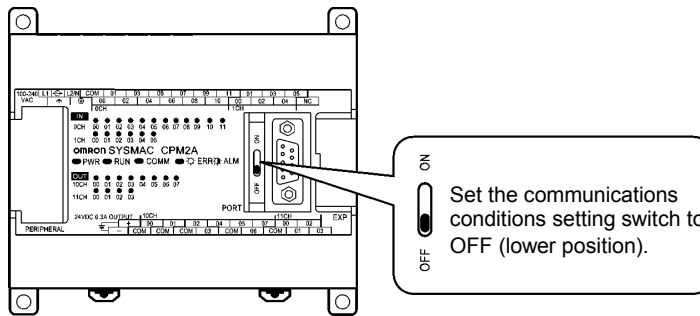

• **Setting the CPM2C Front Panel DIP Switches**

When using a CPM2C, set the switches on the front panel to enable the PLC Setup Area (Data Memory) settings, as follows:

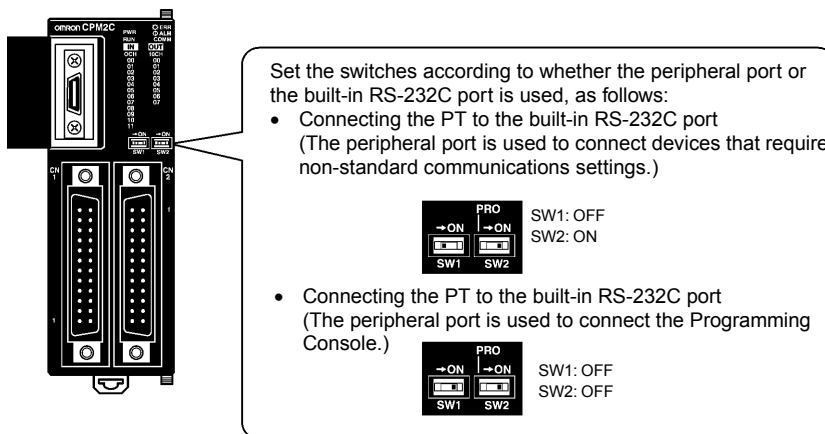

4-1 1:1 Host Connection

• **Setting the Communications Board Switches (Using RS-422A)**

Set the switches of the C200HX/HG/HE(-Z) Communications Board as follows:

Switch 1: 4 (Four-wire method = RS-422A)

Switch 2: ON (terminator ON = terminating resistance used)

Set the switches of the CQM1H Serial Communications Board as follows:

Two-wire/four-wire switch (WIRE): 4 (Four-wire method = RS-422A)

Terminating resistance switch (TERM): ON (terminator ON = terminating resistance used)

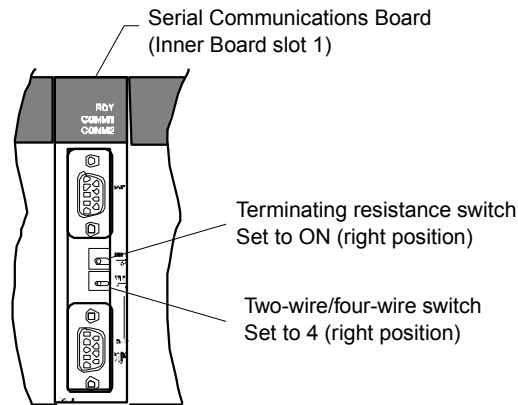

• **Connecting to CVM1/CV Series (-V□) PLCs (Using RS-232C/RS-422A)**

PLC Setup

When using CVM1/CV-series PLCs, always set the Execute Process (Execute Control 2) in the PLC Setup to **synchronous** execution.

Setting the Front Panel DIP Switch

Set the DIP switch on the front panel, as shown in the following diagram.

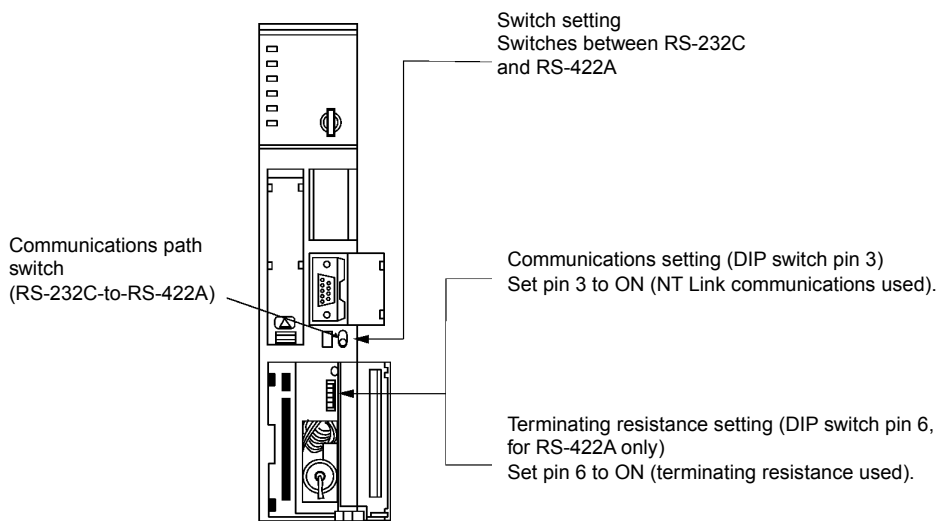

4-2 1:N Host Connection

4-2-1 Connection Methods

This section describes the methods used to connect multiple PTs to a single host in a 1:N connection and provides information on the relationship between the connection methods and the communications methods.

The Host and PTs are connected in a 1:N configuration using RS-422A with an RS-232C/RS-422A Converter.

This connection method can be used for 1:N NT Link connections (normal, high-speed).

The NS15 does not require an adapter if RS-422A is set for serial port B.

The total transmission distance is 500 m when using the NT-AL001, NS-AL002, or the RS-422A port on a NS15 PT. The total transmission distance is 50 m when using the CJ1W-CIF11, even if other adapters are used on the same transmission path.

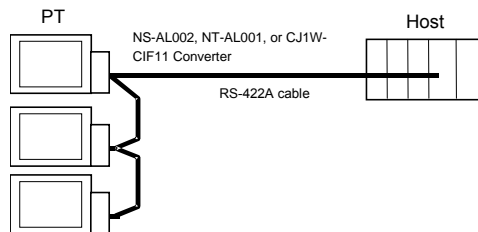

• Supported Host Units

The OMRON PLCs that can be connected in 1:N NT Links are limited to the CS-series, CJ-series, NJ-Series, and C-series PLCs. CS-series PLCs can also be connected in 1:N NT Links by using a Serial Communications Unit. CJ-series PLCs can also be connected in 1:N NT Links by using a Serial Communications Unit. NJ-series PLCs can be connected in 1:N NT Links by using a Serial Communications Unit.

Check the series and model of the PLC and the model of the Board or Unit that is mounted to the PLC when connecting the PTs to the host.

For details on the Units used as hosts that can be connected in 1:N NT Links, refer to *Appendix 8 Standard Models*.

-
- Reference**
- NS-series RS-485 (two-wire) communications are used to connect to an OMRON Temperature Controller. The NS-AL002 cannot be used with the NT-series PTs or PLCs. Always use RS-422A (four-wire).
 - CS-series PLCs with -V1 suffix support high-speed 1:N NT Links as well as normal 1:N NT Links. CS-series PLCs without the -V1 suffix can also be connected to high-speed 1:N NT Links if the latest Serial Communications Board/Unit is used. Refer to *High-speed 1:N NT Link* for details. (page 4-18).
-

4-2-2 Unit Setting Methods

Host Settings

The methods for setting each Unit are as follows:

Connecting C-series C200HX/HG/HE(-Z), and CQM1H PLCs

4-2 1:N Host Connection

PLC Setup Area

Write the settings directly from the Programming Device or Support Software (CX-Programmer, etc.) to the PLC Setup Area (Data Memory) according to the host type and port used.

• Using RS-232C

Host type	Address	Write value	Settings
Built-in RS-232C port of C200HX/HG/HE(-Z)	DM 6645	5□00	Uses 1:N NT Link <input type="checkbox"/> : Largest unit number (1 to 7) of connected PTs. (See note 3.)
Port A of C200HX/HG/HE(-Z) (See note 1.) Port 1 of CQM1H (See note 2.)	DM 6555		
Port B of C200HX/HG/HE(-Z) (See note 1.)	DM 6550		

- Note
1. RS-232C port of Communications Board.
 2. RS-232C port of Serial Communications Board.
 3. The PT unit numbers for the C200HE(-Z) are 1 to 3.

• Using RS-422A

Host type	Address	Write value	Settings
Port A of C200HX/HG/HE(-Z) (See note 1.)	DM 6555	5□00	Uses 1:N NT Link <input type="checkbox"/> : Largest unit number (1 to 7) of the connected PTs. (See note 3.)
Port 2 of CQM1H (See note 2.)	DM 6550	5□00	

- Note
1. RS-422A port of Communications Board.
 2. RS-422A port of Serial Communications Board.
 3. The PT unit numbers for the C200HE(-Z) are 1 to 3.

Refer to the manuals of the PLC being used for details on using the PLC Setup Area.

-
- Reference**
- There is no Communications Board for use with C200HX/HG/HE(-Z) where port B is an RS-422A port.
 - There is no Communications Board for use with CQM1H where Port 1 is an RS-422A port.
 - When setting a 1:N NT Link in the CX-Programmer, set the baud rate to 38,400 bps.
-

Setting the Front Panel DIP Switch

• Using RS-232C

When using C200HX/HG/HE(-Z), set the DIP switch on the front panel to enable the PLC Setup Area (Data Memory) settings, as follows:

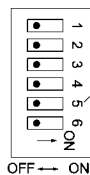

Sets the RS-232C port communications conditions. Set DIP switch pin 5 to OFF to enable the PLC Setup settings.

Setting the Communications Board Switches

• Using RS-422A

Set the switches of the C200HX/HG/HE(-Z) Communications Board, as follows:

Switch 1: 4 (Four-wire method = RS-422A)

Switch 2: ON (terminator ON = terminating resistance used)

Set the switches of the CQM1H Serial Communications Board as follows:

Two-wire/four-wire switch (WIRE): 4 (Four-wire method = RS-422A)

Terminating resistance switch (TERM): ON (terminator ON = terminating resistance used)

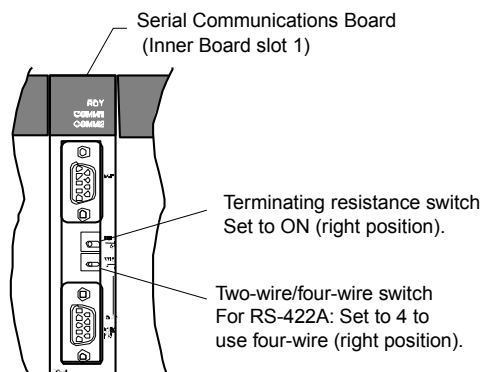

Connecting a CS-series CPU Unit

When a CS-series CPU Unit is connected, settings are required in the PLC Setup and on the front-panel switches of the CPU Unit.

PLC Setup

There are two methods that can be used to change the parameters in the PLC Setup.

- CX-Programmer
- Programming Console

Using the CX-Programmer

Precautions for Safe Use

If one or more parameters in the PLC Setup in the CPU Unit has been previously changed, always upload the PLC Setup from the CPU Unit and make any new changes in the uploaded copy so that you do not overwrite the previous changes.

1. Open the project file in the CX-Programmer and select **PLC - PLC Information - PLC Settings** from the menus.
2. The PLC Settings Dialog Box will be displayed. Click the tab for the port to which the PT is connected and change the following three parameters. (The following screen capture is provided as an example. The parameters that are actually displayed will depend on the model of the CPU Unit and the port.)

4-2 1:N Host Connection

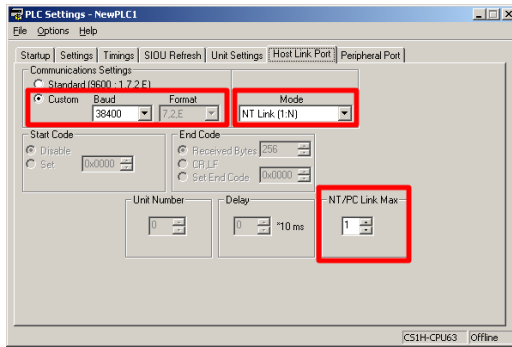

Item	Description
Baud	Select the Custom Option and set the baud rate to 38,400 bps (Standard 1:N NT Link Mode). The format does not need to be changed.
Mode	Set the mode to the 1:N NT Link Mode.
NT/PLC Link Max.	If only one PT is connected to the port and it has a unit number of 0, set this parameter to 1. Otherwise, set the highest unit number of all the PTs that are connected.

Using a Programming Console

If the PT is connected to the Host Link port (RS-232C port), connect the Programming Console to the CPU Unit and set the following values at the specified addresses of the PLC Set-up.

PLC Set-up address	Setting to write	Description
160	8200 hex	Specifies using the Host Link port in 1:N NT Link Mode.
161	0000 to 0009 hex	Specifies the standard communications speed (38,400 bps). It does not matter what value between 0000 and 0009 is set.
166	000□ hex	If only one PT is connected to the port and it has a unit number of 0, replace the box at the left with 1. Otherwise, replace the box with the highest unit number of all the PTs that are connected.

Reference If the PT is connected to the peripheral port make the above settings in words 144, 145, and 150 of the PLC Setup instead of 160, 161, 166.

Setting the Front Panel Switches

• Using RS-232C

Set DIP switch pin 4 or 5 of the CPU Unit according to the port to which the PT is connected, as follows:

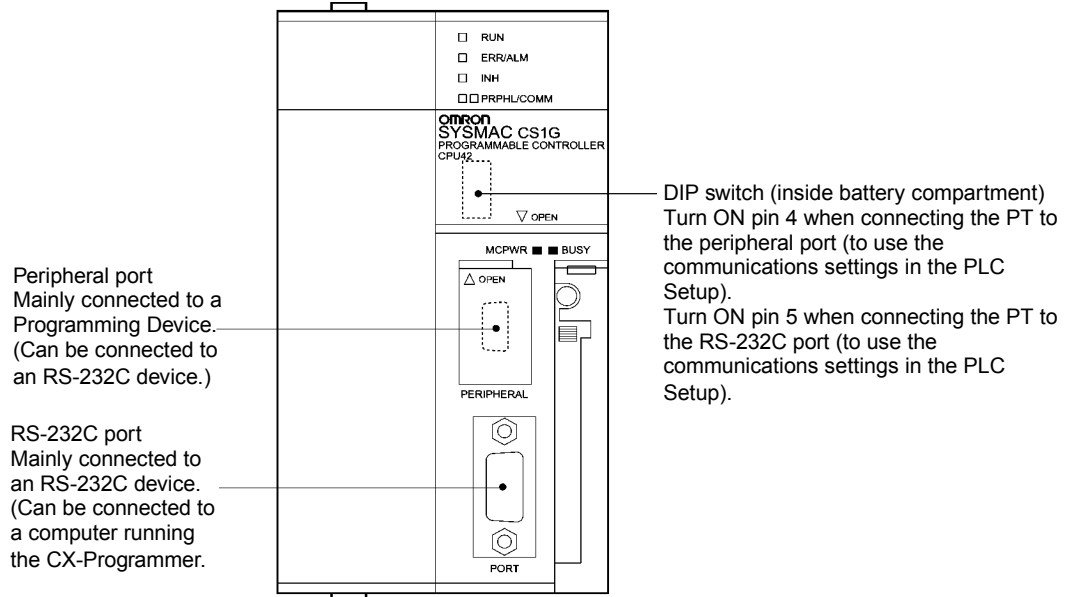

Connecting a CJ-series CPU Unit

When a CJ-series CPU Unit is connected, settings are required in the PLC Setup and on the front-panel switches of the CPU Unit.

PLC Setup

There are two methods that can be used to change the parameters in the PLC Setup.

- CX-Programmer
- Programming Console (CJ1 CPU Units only)

Using the CX-Programmer

Precautions for Safe Use

If one or more parameters in the PLC Setup in the CPU Unit has been previously changed, always upload the PLC Setup from the CPU Unit and make any new changes in the uploaded copy so that you do not overwrite the previous changes.

3. Open the project file in the CX-Programmer and select **PLC - PLC Information - PLC Settings** from the menus.
4. The PLC Settings Dialog Box will be displayed. Click the tab for the port to which the PT is connected and change the following three parameters. (The following screen capture is provided as an example. The parameters that are actually displayed will depend on the model of the CPU Unit and the port.)

4-2 1:N Host Connection

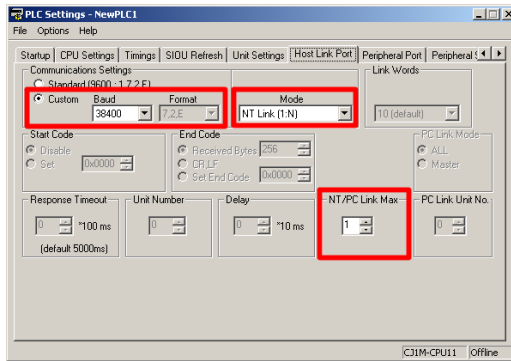

Item	Description
Baud	Select the Custom Option and set the baud rate to 38,400 bps (Standard 1:N NT Link Mode). The format does not need to be changed.
Mode	Set the mode to the 1:N NT Link Mode.
NT/PLC Link Max.	If only one PT is connected to the port and it has a unit number of 0, set this parameter to 1. Otherwise, set the highest unit number of all the PTs that are connected.

Using a Programming Console (CJ1 CPU Units Only)

If the PT is connected to the Host Link port (RS-232C port), connect the Programming Console to the CPU Unit and set the following values at the specified addresses of the PLC Set-up.

PLC Set-up address	Setting to write	Description
160	8200 hex	Specifies using the Host Link port in 1:N NT Link Mode.
161	0000 to 0009 hex	Specifies the standard communications speed (38,400 bps). It does not matter what value between 0000 and 0009 is set.
166	000□ hex	If only one PT is connected to the port and it has a unit number of 0, replace the box at the left with 1. Otherwise, replace the box with the highest unit number of all the PTs that are connected.

Reference If the PT is connected to the peripheral port of the CPU Unit, make the above settings in words 144, 145, and 150 of the PLC Setup instead of 160, 161, 166.

Setting the Front Panel Switches

• Using RS-232C

Set DIP switch pin 4 or 5 of the CPU Unit according to the port to which the PT is connected, as shown below. (The following figure shows a CJ1G CPU Unit. The arrangement depends on the CPU Unit, but the DIP switch settings are the same.)

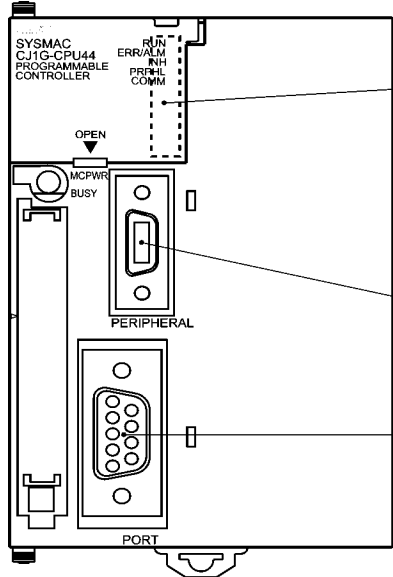

DIP switch (inside battery compartment)
 Turn ON pin 4 when connecting the PT to the peripheral port (to use the communications settings in the PLC Setup).
 Turn ON pin 5 when connecting the PT to the RS-232C port (to use the communications settings in the PLC Setup).

Peripheral port
 Connected to a Programming Console or other device.

RS-232C port
 Connected to a Programming Console or other device.

Connecting to CS-series Serial Communications Boards

Serial Communications Boards with RS-232C and RS-422A Ports for Use with CS-series CPU Units:

CS1W-SCB21 (Both ports 1 and 2 are RS-232C ports.)

CS1W-SCB41 (Port 1 is an RS-232C port and Port 2 is an RS-422A port.)

Setting DM Area Allocations in CPU Unit

Write the settings directly from the Programming Device or Support Software (Programming Console or CX-Programmer) to the DM Area (Parameter Area) in the CPU Unit. After writing the settings, enable the settings by turning ON the power again, restarting the Unit, restarting the communications port, or executing the CHANGE SERIAL PORT SETUP (STUP) instruction.

The following table shows the allocated DM Area words and settings.

The allocations and settings are the same for RS-232C and RS-422A (CS1W-SCB41 Port 2).

Allocated DM Area words		Write value	Settings
Port 1	Port 2		
DM32000	DM32010	8200	1:N NT Link Mode
DM32001	DM32011	0000 to 0009 (See note 1.)	Baud rate (normal)
DM32006	DM32016	000□	□: Largest unit number (1 to 7) of the connected PTs. (See note 2.)

Note 1. Set the baud rate to a numeric value between 0000 to 0009 Hex. (The setting is the same for any value between 0000 and 0009 Hex.)

2. When using a 1:N connection, set the value for □ to 1 or higher.

For example, to connect PTs with unit numbers 3 to 6 to Port 1 in 1:N NT Links, set DM32000 to 8200 Hex, DM32001 to 0000 Hex, and DM32006 to 0006 Hex.

Reference When setting a 1:N NT Link in the CX-Programmer, set the baud rate to 38,400 bps.

Setting the Front Panel Switches

• Using RS-422A

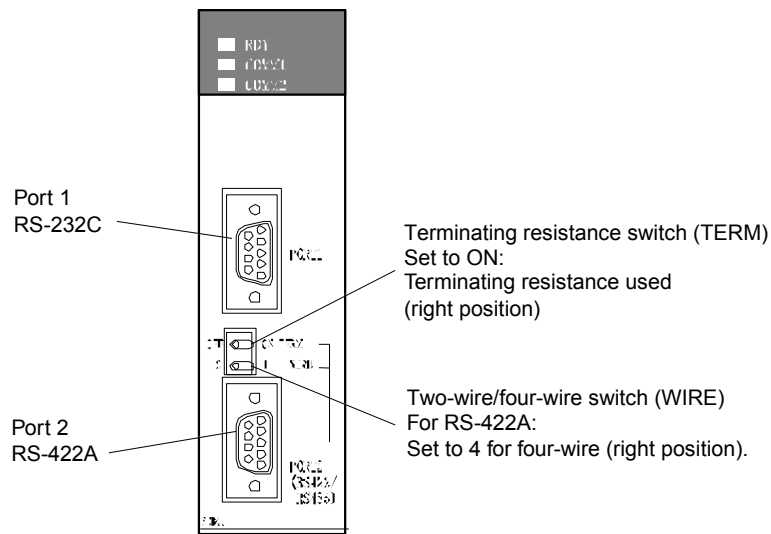

Connecting to CS-series Serial Communications Units

CS-series Rack-mounted Type:

- CS1W-SCU21 (Both ports 1 and 2 are RS-232C ports.)
- CS1W-SCU31 (Both ports 1 and 2 are RS-422A ports.)

CPU Unit DM Area Settings

• Using RS-232C

Write the settings directly from the Programming Device or Support Software (Programming Console or CX-Programmer) to the DM Area (Parameter Area) in the CPU Unit. After writing the settings, enable the settings by turning ON the power again, restarting the Unit, restarting the communications port, or executing the CHANGE SERIAL PORT SETUP (STUP) instruction.

The following table shows the allocated DM Area words and settings.

$m = 30000 + 100 \times \text{unit number}$

Allocated DM Area words		Write value	Settings
Port 1	Port 2		
DM m	DM m + 10	8200	1:N NT Link Mode
DM m + 1	DM m + 11	0000 to 0009 (See note 1.)	Baud rate (normal)
DM m + 6	DM m + 16	000□	□: Largest unit number (1 to 7) of the connected PTs. (See note 2.)

- Note 1. Set the baud rate to a numeric value between 0000 to 0009 Hex. (The setting is the same for any value between 0000 and 0009 Hex.)
2. When using a 1:N connection, set the value for □ to 1 or higher.

Reference When setting a 1:N NT Link in the CX-Programmer, set the baud rate to 38,400 bps.

Setting the Front Panel Switches

• **Using RS-232C**

Set the unit number of the Serial Communications Unit with the rotary switches on the front of the Unit. Use a flat-blade screwdriver to set the numerals and symbols in the switches setting display window, as follows:

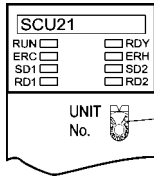

Unit number setting
Set a value between 0 and F that is not the same as that of other Units in the system.

Connecting to CJ-series Serial Communications Units

CJ-series Units:

- CJ1W-SCU41/42 (Port 1 is an RS-422A port and Port 2 is an RS-232C port.)
- CJ1W-SCU31/32 (Both ports 1 and 2 are RS-422A ports.)

CPU Unit DM Area Settings

Write the settings directly from the Programming Device or Support Software (Programming Console or CX-Programmer) to the DM Area (Parameter Area) in the CPU Unit. After writing the settings, enable the settings by turning ON the power again, restarting the Unit, restarting the communications port, or executing the CHANGE SERIAL PORT SETUP (STUP) instruction.

The following table shows the allocated DM Area words and settings.

The allocations and settings are the same for RS-232C and RS-422A.

$$m = 30000 + 100 \times \text{unit number}$$

Allocated DM Area words		Write value	Settings
Port 1	Port 2		
DM m	DM m + 10	8200	1:N NT Link Mode
DM m + 1	DM m + 11	0000 to 0009 (See note 1.)	Baud rate (normal)
DM m + 6	DM m + 16	000□	□: Largest unit number (1 to 7) of the connected PTs. (See note 2.)

Note 1. Set the baud rate to a numeric value between 0000 to 0009 Hex. (The setting is the same for any value between 0000 and 0009 Hex.)

2. When using a 1:N connection, set the value for □ to 1 or higher.

Reference When setting a 1:N NT Link in the CX-Programmer, set the baud rate to 38,400 bps.

Setting the Front Panel Switches

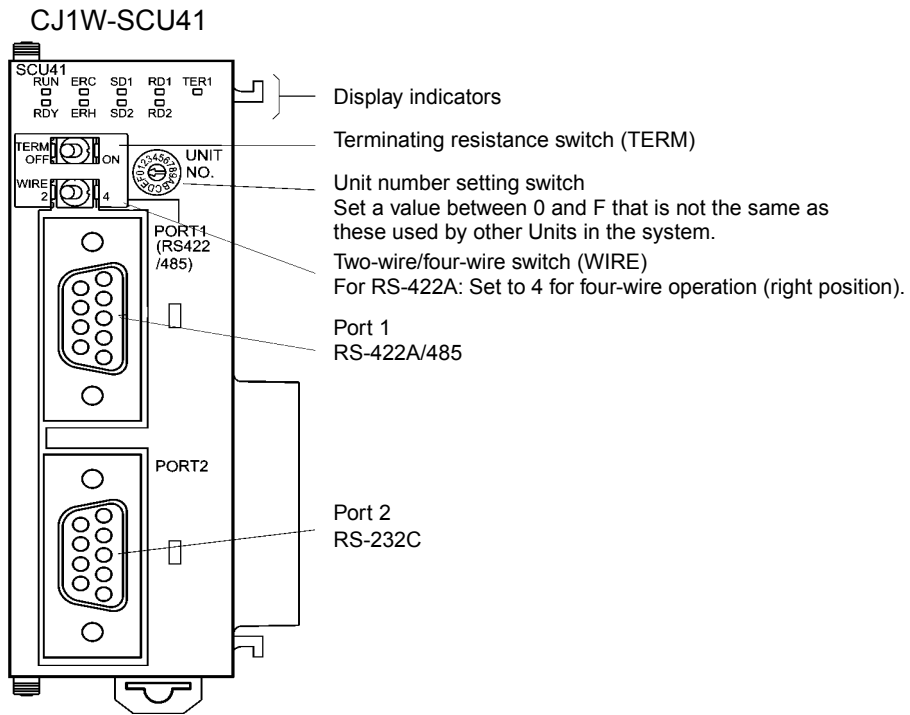

4-3 High-speed 1:N NT Link

- **Supported Host Units**

The OMRON PLCs that can be connected to high-speed 1:N NT Links using RS-232C are as follows:

CS-series PLCs: CS1G/H-V1 and CS1G/H-H

CJ-series PLCs: CJ1G, CJ1G/H-H, CJ1M, CJ2H, and CJ2M

NJ-series PLCs: NJ501, NJ301, and NJ101

CS-series PLCs can also be connected in high-speed 1:N NT Links by using a Serial Communications Unit or Serial Communications Board. (CS-series PLCs without a -V1 suffix can also be connected in high-speed 1:N NT Links if a Serial Communications Board/Unit is used.) CJ-series PLCs can also be connected in high-speed 1:N NT Links by using a Serial Communications Unit. NJ-series PLCs can be connected in high-speed 1:N NT Links by using a Serial Communications Unit.

The OMRON PLCs that can be connected in high-speed 1:N NT Links using RS-422A are as follows:

CS-series PLCs: CS1G/H and CS1G/H-H

CJ-series PLCs: CJ1G/H-H, CJ1G, CJ1M, CJ2H, and CJ2M

NJ-series PLCs: NJ501, NJ301, and NJ101

CS-series PLCs can also be connected in high-speed 1:N NT Links by using a Serial Communications Unit or Serial Communications Board. (CS-series PLCs without -V1 suffix can also be connected in high-speed 1:N NT Links if a Serial Communications Board/Unit is used.) CJ-series PLCs can also be connected in high-speed 1:N NT Links by using a Serial Communications Unit. NJ-series PLCs can be connected in high-speed 1:N NT Links by using a Serial Communications Unit.

Check the series and model of the PLC and the model of the Board or Unit that are mounted to the PLC when connecting the PT to the host. For details on the PLCs that can be connected, refer to *Appendix 8 Standard Models*.

4-3-1 Unit Setting Methods

The methods for setting each Unit are as follows:

Connecting a CS-series CPU Unit

When a CS-series CPU Unit is connected, settings are required in the PLC Setup and on the front-panel switches of the CPU Unit.

PLC Setup

There are two methods that can be used to change the parameters in the PLC Setup.

- CX-Programmer
- Programming Console

Using the CX-Programmer

Precautions for Safe Use

If one or more parameters in the PLC Setup in the CPU Unit has been previously changed, always upload the PLC Setup from the CPU Unit and make any new changes in the uploaded copy so that you do not overwrite the previous changes.

1. Open the project file in the CX-Programmer and select **PLC - PLC Information - PLC Settings** from the menus.
2. The PLC Settings Dialog Box will be displayed. Click the tab for the port to which the PT is connected and change the following three parameters. (The following screen capture is provided as an example. The parameters that are actually displayed will depend on the model of the CPU Unit and the port.)

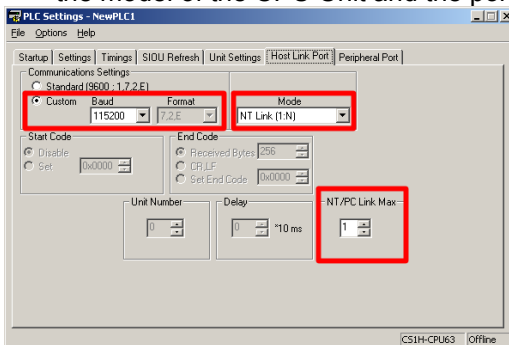

Item	Description
Baud	Select the Custom Option and set the baud rate to 115,200 bps (High-speed 1:N NT Link Mode). The format does not need to be changed.
Mode	Set the mode to the 1:N NT Link Mode.
NT/PLC Link Max.	If only one PT is connected to the port and it has a unit number of 0, set this parameter to 1. Otherwise, set the highest unit number of all the PTs that are connected.

4-3 High-speed 1:N NT Link

Using a Programming Console

If the PT is connected to the Host Link port (RS-232C port), connect the Programming Console to the CPU Unit and set the following values at the specified addresses of the PLC Set-up.

PLC Set-up address	Setting to write	Description
160	8200 hex	Specifies using the Host Link port in 1:N NT Link Mode.
161	000A hex	Baud rate: High-speed (115,200 bps)
166	000□ hex	If only one PT is connected to the port and it has a unit number of 0, replace the box at the left with 1. Otherwise, replace the box with the highest unit number of all the PTs that are connected.

Reference If the PT is connected to the peripheral port make the above settings in words 144, 145, and 150 of the PLC Setup instead of 160, 161, 166.

Setting the Front Panel Switches

Using RS-232C

Set DIP switch pin 4 or 5 of the CPU Unit according to the port to which the PT is connected, as follows:

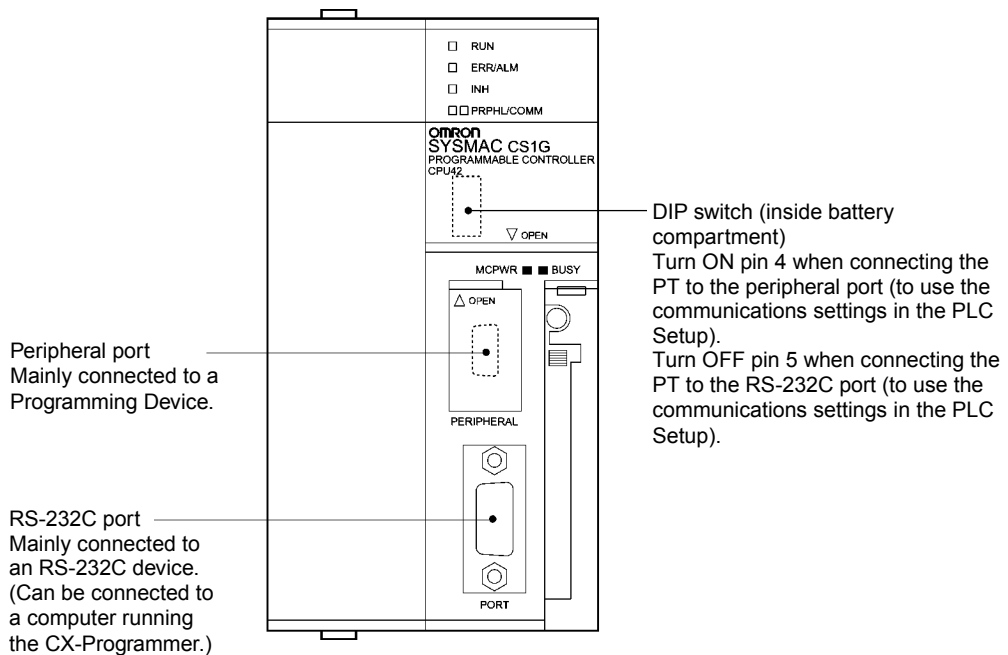

Connecting a CJ-series CPU Unit

When a CJ-series CPU Unit is connected, settings are required in the PLC Setup and on the front-panel switches of the CPU Unit.

PLC Setup

There are two methods that can be used to change the parameters in the PLC Setup.

- CX-Programmer
- Programming Console (CJ1 CPU Units only)

Using the CX-Programmer

Precautions for Safe Use

If one or more parameters in the PLC Setup in the CPU Unit has been previously changed, always upload the PLC Setup from the CPU Unit and make any new changes in the uploaded copy so that you do not overwrite the previous changes.

3. Open the project file in the CX-Programmer and select **PLC - PLC Information - PLC Settings** from the menus.
4. The PLC Settings Dialog Box will be displayed. Click the tab for the port to which the PT is connected and change the following three parameters. (The following screen capture is provided as an example. The parameters that are actually displayed will depend on the model of the CPU Unit and the port.)

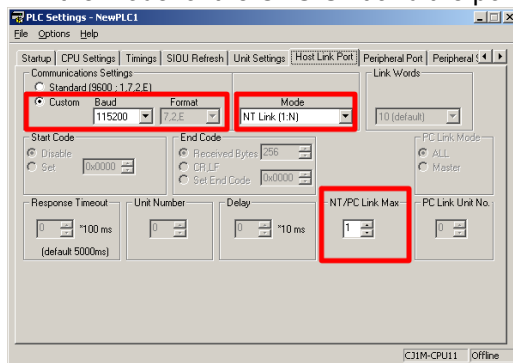

Item	Description
Baud	Select the Custom Option and set the baud rate to 115,200 bps (High-speed 1:N NT Link Mode). The format does not need to be changed.
Mode	Set the mode to the 1:N NT Link Mode.
NT/PLC Link Max.	If only one PT is connected to the port and it has a unit number of 0, set this parameter to 1. Otherwise, set the highest unit number of all the PTs that are connected.

4-3 High-speed 1:N NT Link

Using a Programming Console (CJ1 CPU Units Only)

If the PT is connected to the Host Link port (RS-232C port), connect the Programming Console to the CPU Unit and set the following values at the specified addresses of the PLC Set-up.

PLC Set-up address	Setting to write	Description
160	8200 hex	Specifies using the Host Link port in 1:N NT Link Mode.
161	000A hex	Baud rate: High-speed (115,200 bps)
166	000□ hex	If only one PT is connected to the port and it has a unit number of 0, replace the box at the left with 1. Otherwise, replace the box with the highest unit number of all the PTs that are connected.

Reference If the PT is connected to the peripheral port of the CPU Unit, make the above settings in words 144, 145, and 150 of the PLC Setup instead of 160, 161, 166.

Setting the Front Panel Switches

• Using RS-232C

Set DIP switch pin 4 or 5 of the CPU Unit according to the port to which the PT is connected, as shown below. (The following figure shows a CJ1G CPU Unit. The arrangement depends on the CPU Unit, but the DIP switch settings are the same.)

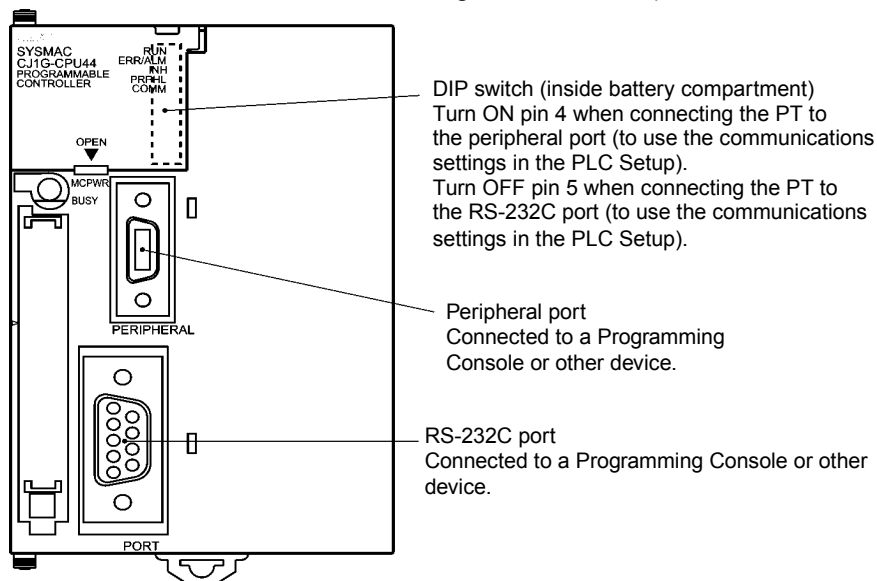

Connecting to CS-series Serial Communications Boards

Serial Communications Boards with RS-232C Port for Use with CS-series CPU Units:

CS1W-SCB21 (Both ports 1 and 2 are RS-232C ports.)

CS1W-SCB41 (Port 1 is an RS-232C port and Port 2 is an RS-422A port.)

Reference High-speed 1:N NT Links can be used with Serial Communications Boards and Serial Communications Units from lot numbers 991220 (December 20, 1999) or later. Boards and Units with earlier lot numbers cannot be used, so confirm that the lot number is supported.

CPU Unit DM Area Settings

Write the settings directly from the Programming Device (Programming Console) or Support Software (CX-Programmer) to the DM Area (Parameter Area) in the CPU Unit. After writing the settings, enable the settings by turning ON the power again, restarting the Unit, restarting the communications port, or executing the CHANGE SERIAL PORT SETUP (STUP) instruction.

The following table shows the allocated DM Area words and settings. The settings are the same for RS-232C and RS-422A (CS1W-SCB41 Port 2).

Allocated DM Area words		Write value	Settings
Port 1	Port 2		
DM32000	DM32010	8200	1:N NT Link Mode
DM32001	DM32011	000A	Baud rate (high-speed)
DM32006	DM32016	000□	□: Largest unit number (1 to 7) of the connected PTs. (See note.)

Note: When connecting a single Unit in a 1:N connection, set the value of □ to 1 or higher.

For example, to connect PTs with unit numbers 3 to 6 to Port 1 in 1:N NT Links, set DM32000 to 8200 Hex, DM32001 to 000A Hex, and DM32006 to 0006 Hex.

Serial Communications Boards with RS-422A Port for Use with CS-series CPU Units:

CS1W-SCB41 (Port 2 is an RS-422A port.)

Reference To set high-speed 1:N NT Link communications from the CX-Programmer, set the baud rate to 115,200 bps.

Setting the Front Panel Switches

• **Using RS-422A**

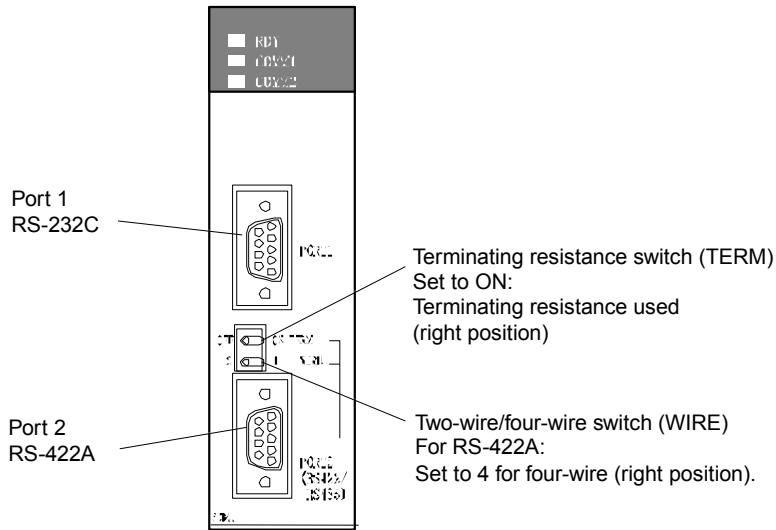

Connecting to CS-series Serial Communications Units

CS-series Rack-mounted Type:

- CS1W-SCU21
- CS1W-SCU31

Reference High-speed 1:N NT Links can be used with Serial Communications Boards and Serial Communications Units from lot numbers 991220 (December 20, 1999) or later. Boards and Units with earlier lot numbers cannot be used, so confirm that the lot number is supported.

CPU Unit DM Area Settings

Write the settings directly from the Programming Device (Programming Console) or Support Software (CX-Programmer) to the DM Area (Parameter Area) in the CPU Unit. After writing the settings, enable the settings by turning ON the power again, restarting the Unit, restarting the communications port, or executing the CHANGE SERIAL PORT SETUP (STUP) instruction.

The following table shows the allocated DM Area words and settings.

Using RS-232C

$$m = 30000 + 100 \times \text{unit number}$$

Allocated DM Area words		Write value	Settings
Port 1	Port 2		
DM m	DM m + 10	8200	1:N NT Link Mode
DM m + 1	DM m + 11	000A	Baud rate (high-speed)
DM m + 6	DM m + 16	000□	□: Largest unit number (1 to 7) of the connected PTs. (See note.)

Note: When connecting a single Unit in a 1:N connection, set the value of □ to 1 or higher.

Reference To set high-speed 1:N NT Link communications from the CX-Programmer, set the baud rate to 115,200 bps.

Setting the Front Panel Switches

Set the unit number of the Serial Communications Unit with the rotary switches on the front of the Unit. Use a flat-blade screwdriver to set the numerals and symbols of the switch's setting display window, as follows:

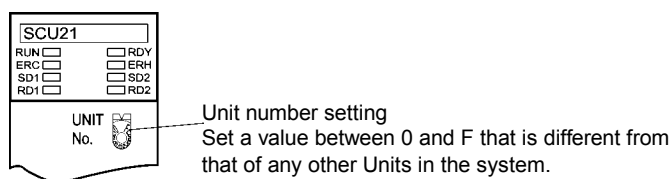

Connecting to CJ-series Serial Communications Units

CJ-series Units:

- CJ1W-SCU21/22 (Both ports 1 and 2 are RS-232C ports.)
- CJ1W-SCU31/32 (Both ports 1 and 2 are RS-422A ports.)
- CJ1W-SCU41/42 (Port 1 is an RS-422A port and Port 2 is an RS-232C port.)

CPU Unit DM Area Settings

Write the settings directly from the Programming Device (Programming Console or CX-Programmer) to the DM Area (Parameter Area) in the CPU Unit. After writing the settings, enable the settings by turning ON the power again, restarting the Unit, restarting the communications port, or executing the CHANGE SERIAL PORT SETUP (STUP) instruction.

The following table shows the allocated DM Area words and settings.

The allocations and settings are the same for RS-232C and RS-422A.

$$m = 30000 + 100 \times \text{unit number}$$

Allocated DM Area words		Write value	Settings
Port 1	Port 2		
DM m	DM m + 10	8200	1:N NT Link Mode
DM m + 1	DM m + 11	000A	Baud rate (high-speed)
DM m + 6	DM m + 16	000□	□: Largest unit number (1 to 7) of the connected PTs. (See note.)

Note: When connecting a single Unit in a 1:N connection, set the value of □ to 1 or higher.

Reference To set high-speed 1:N NT Link communications from the CX-Programmer, set the baud rate to 115,200 bps.

Setting the Front Panel Switches

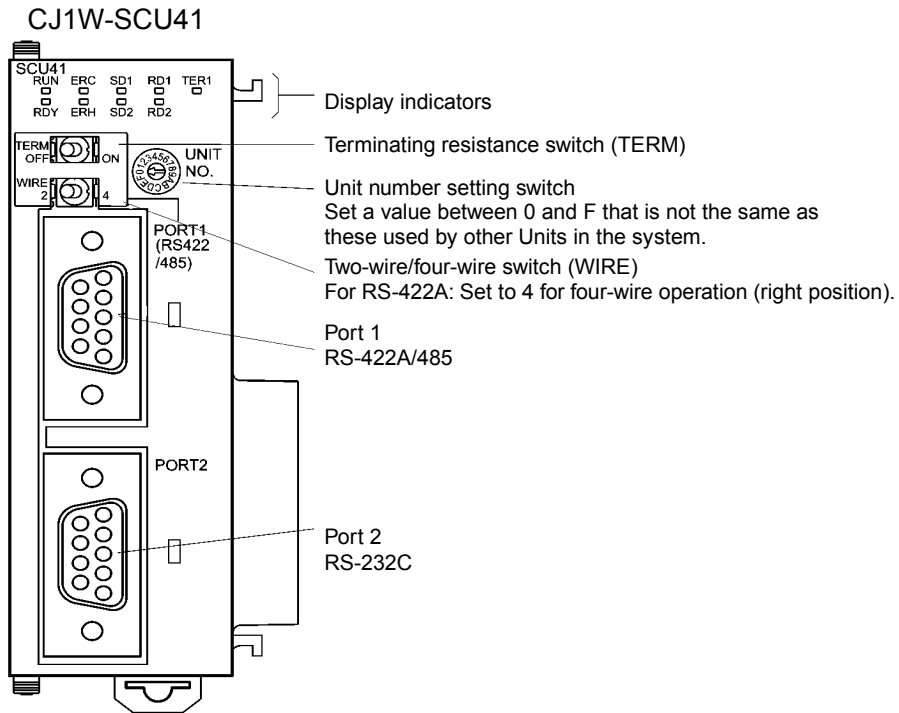

4-4 Recommended Connector Cables

Always use recommended connectors, connector hoods, and cables, where possible, when making connector cables. Depending on the Unit, a connector and connector hood may be included with the Unit.

Check the required components before preparing them.

Name	Model	Details	Units with the connectors and connector hoods included.
Connector	XM3A-0921 or equivalent	9-pin type made by OMRON.	C-series CQM1 and C200HS C200HX/HG/HE(-Z) CVM1/CV-series CPU Units CV500-LK201
	XM3A-2521 or equivalent	25-pin type made by OMRON.	CV500-LK201 C200H-LK201-V1
Connector Hood	XM2S-0911 or equivalent	9-pin type made by OMRON. (mm screws)	C-series CQM1 and C200HS C200HX/HG/HE(-Z) CVM1/CV-series CPU Units CV500-LK201
	XM2S-0911-E or equivalent	9-pin type made by OMRON.	
	XM2S-0913 or equivalent	9-pin type made by OMRON. (inch screws)	
	XM2S-2511 or equivalent	25-pin type made by OMRON.	CV500-LK201 C200H-LK201-V1
Cable	AWG28 × 5P IFVV-SB	Multiconductor shielded cable made by Fujikura Densen, Ltd.	
	CO-MA-VV-SB 5P × 28AWG	Multiconductor shielded cable made by Hitachi Densen, Ltd.	

Precautions for Safe Use

Do not pull on the cables or bend the cables beyond their natural limit.
Do not place heavy objects on top of the cables or other wiring lines. Doing so may break the cables.

• OMRON Cables with Connectors

The following OMRON Cables with Connectors can be used.

Model	Cable length	Connector specifications
XW2Z-200T	2 m	9-pin-to-9-pin
XW2Z-500T	5 m	
XW2Z-200T-2	2 m	9-pin-to-CPM2C peripheral port
XW2Z-500T-2	5 m	

• OMRON RS-232C/RS-422A Converter

Model	Connection method	Terminal block specifications
NS-AL002	Connects directly to RS-232C port.	8-pole terminal block (1:N NT Link)
CJ1W-CIF11	Connects directly to RS-232C port.	5-pole terminal block (1:N NT Link)

The connectors for the connecting cables are not included with the PT and must be purchased separately.

4-4 Recommended Connector Cables

Section 5

Connecting to Host via Ethernet or Controller Link

This section describes the methods for connecting the PT to the host using the PT's Ethernet interface and the Controller Link Interface Unit.

5-1	Connecting to Host Via Ethernet.....	5-2
5-1-1	Host Types and Settings	5-3
5-2	Connecting to the Host Using Controller Link.....	5-16
5-2-1	What Is a Controller Link Network?	5-16
5-2-2	Data Links	5-17
5-2-3	Troubleshooting Using Indicators	5-22
5-3	Connecting to Host via EtherNet/IP	5-25
5-3-1	What is EtherNet/IP?	5-25
5-3-2	Selecting Network Configuration Devices	5-26
5-3-3	Network Installation	5-29
5-3-4	Host Types and Settings	5-31

5-1 Connecting to Host Via Ethernet

To connect to the network using Ethernet, the network number, node number, and IP address must be set. Use the CX-Designer to set the settings. For details, refer to *System Settings and Project Properties* in the CX-Designer's Online Help.

The following connection methods are possible when connecting via the Ethernet only.

- **Connecting PT Directly to the Host**

Connect the PT to the host using twisted-pair cross cable.

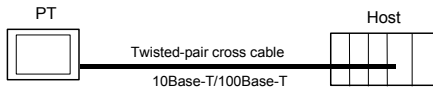

- **Connecting PT to Host with a Hub**

Multiple PTs and hosts can be connected using twisted-pair straight cable and a hub.

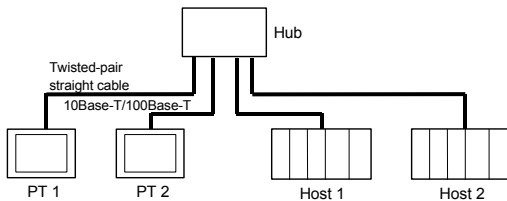

- **Connecting PT and Host Using Transceivers**

PTs can be connected in a 10Base-5 network configuration by using a hub and transceiver that support 10Base-5.

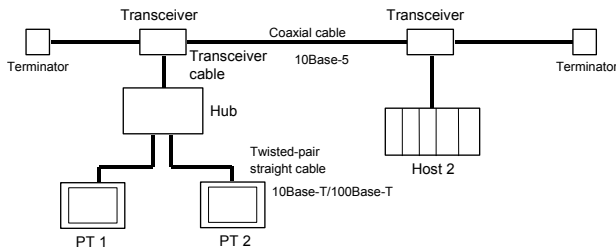

- **Devices Required for Network Configuration**

The following additional devices are required to configure the network using the Ethernet and must be purchased separately.

Always use products that conform to IEEE802.3 standards for all network configuration devices.

Network configuration device	Details
Ethernet Unit	A Communications Unit for connecting the PLC to the Ethernet network.
Hub	A network device that serves as a central wiring point for multiple terminals.
Twisted-pair cable	Cable consisting of four pairs of thin, copper wires twisted into a cross cable or a straight cable. Twisted-pair cables are used for 10/100Base-T networks.
Coaxial cable	Cable consisting of a central conductor surrounded (in concentric circles) by insulation and an external conductor of braided wire. This cable is used for 10Base-5 networks.
Transceiver	A device that serves as an interface between the coaxial cable and nodes.
Transceiver cable	Cable used to connect the transceiver to the nodes.
24-VDC power supply	A 24-VDC external power supply for supplying power to the transceiver through the transceiver cable.
Coaxial cable terminator (terminating resistance)	Connected to both ends of the coaxial cable.

Recommended Network Configuration Devices

The following products are recommended for configuring the network when an Ethernet Unit is used.

Configuration devices		Maker	Model	URL
Hub		Phoenix Contact	FL SWITCH 5TX (5-port switching hub) Note: For FA environment	http://www.phoenixcontact.com/jp
Twisted-pair cable	100Base-TX	Fujikura	CTP45-LAN5 0.5 mm x 4P Specifications: UTP cable (unshielded twisted-pair cable) Category 5, 5e	http://www.fujikura.co.jp/ie_e.html
	10Base-T	Fujikura	CTP45-LAN5 0.5 mm x 4P Specifications: UTP cable (unshielded twisted-pair cable) Category 5, 5e	
Connectors (Modular plug)		Panduit Corp.	MP588-C	http://www.panduit.com

5-1-1 Host Types and Settings

Units that are used for Ethernet communications vary according to the type and series of OMRON PLC used.

When connecting an Ethernet Unit, check the series and type of the PLC that it will be connected to and the model of the Unit that is mounted to the PLC.

For details on the hosts that can be connected to NS-series PTs via the Ethernet, refer to *Appendix 8 Standard Models*.

The types of hosts that can be connected to NS-series PTs with the Ethernet and the host settings are as follows:

• **Host Settings**

The following settings must be set at the host.

Item	Host Settings
Network number	1 to 127
Conversion table	Node number: 1 to 254 IP address: 0.0.0.0 to 255.255.255.255
UDP port number	1 to 65535, default is 9600.
IP address	0.0.0.0 to 255.255.255.255
Subnet mask	0.0.0.0 to 255.255.255.255
Default gateway	0.0.0.0 to 255.255.255.255
IP proxy address	""(blank), 0.0.0.0 to 255.255.255.255
Node number	1 to 254
Routing tables	Define communications paths for FINS messages. Routing tables are set from the CX-Programmer.

IP Address Configuration

The IP address is comprised of 32 bits of binary data, consisting of the net ID and host ID. The net ID is the address that identifies the network, and the host ID is the ID that identifies the host (node).

The IP address is divided into class A, B, and C. Select the address system from among the classes according to the network configuration.

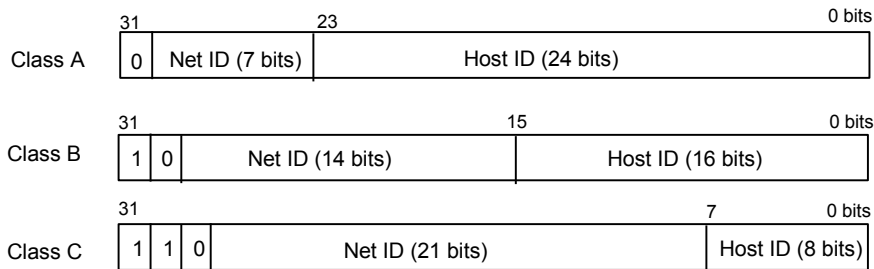

The number of networks and hosts that can be identified depends on the class used.

Class	Number of networks	Number of hosts
Class A	Small	$2^{24} - 2$ max. (16,777,214 max.)
Class B	Medium	$2^{16} - 2$ max. (65,534 max.)
Class C	Large	$2^8 - 2$ max. (254 max.)

The IP address is a 32-bit value divided into four 8-bit fields. Each octet is expressed as a decimal and is separated by a period.

Example: 10000010 00111010 00010001 00100000 → 130.58.17.32

Reference

- Set the same net ID for all nodes in the same network.
- The net ID of the IP address is the value that identifies the Ethernet network (IP network segment). The net ID is not the same as the network address used for FINS communications.
- The IP network segment is the logical network unit that is configured by the nodes that have the same net ID.

IP Address Allocation

The IP addresses are allocated so that they are unique for each node in the network (or between two or more networks). If two or more nodes are allocated the same IP address, the remote nodes with the same IP address will also malfunction.

IP (Internet Protocol) is a communications protocol that conforms to international standards. Therefore, to connect to the Internet, always obtain IP addresses that have been allocated by a public organization (i.e., the NIC in the country of use, such as the JPNIC in Japan). Using IP addresses that are not recognized by the NIC (JPNIC) to connect to the Internet could have unforeseen social consequences, such as causing the networks of another organizations to malfunction unexpectedly.

Local IP Address

The local IP address indicates the IP address of the Ethernet Unit that is used to set the settings.

The following IP address settings are not possible.

- Net ID with all bits set to 0 or 1.
- Host ID with all bits set to 0 or 1.
- Subnet ID with all bits set to 1.
- IP addresses that begin with 127 (7F Hex) (e.g., 127.35.21.16).

Subnet Mask

When more than one node is connected to the network, network operation and management can be difficult. Therefore, for convenience, configure the system by dividing a single network into multiple sub-networks. The system operates internally as multiple networks, but externally appears as a single network.

To operate a system in this way, divide the host ID field of the IP address into a subnet ID field and a host ID field.

The subnet ID field is identified by the information in the subnet mask. The subnet mask is a bit mask in which the net ID and subnet ID fields are 1 and the host ID field is 0.

Example: 11111111 11111111 11111111 00000000 → FFFFFFF0

The subnet mask must have a value that is common to all nodes on the same sub-network.

Setting the subnet mask is not required if sub-networks are not used. The system recognizes subnet masks without a subnet ID field (i.e., subnet masks with net ID and host ID fields only).

Address Conversion (when Using FINS Communications Service Only)

When using the FINS communications service, nodes must be specified following the FINS addressing system. Data that is transmitted on the Ethernet network using FINS communications, however, must follow the IP address format. Address conversion changes the FINS address to an IP address.

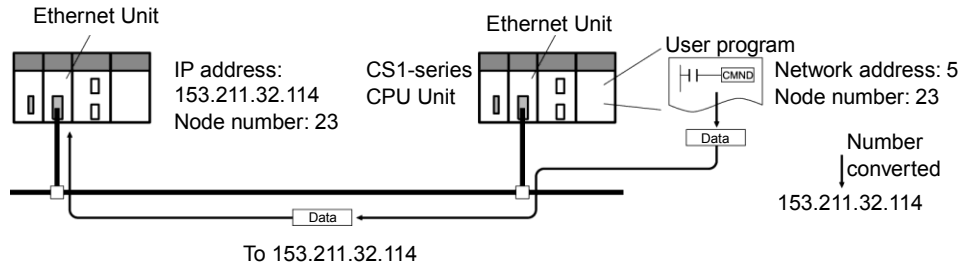

There are three methods for converting addresses, as follows:

- Automatic generation method (default address conversion)
- IP address table method
- IP table + automatic generation method

All of these address conversion methods are performed from the system settings using the Support Software (CX-Programmer, SYSMAC-CPT, SYSMAC Support Software, or CV Port Software Ver.2 or later). The details for each method are explained below. Refer to the *SYSMAC CS/CJ Series Ethernet Unit Operation Manual* (Cat. No. W343) and the *SYSMAC CVM1/CV Series Ethernet Unit Operation Manual* (Cat. No. W242) for details on setting methods.

Automatic Generation Method

The automatic generation method uses the FINS node number without modification as the host ID of the IP address. The net ID of the local IP address is used as the net ID.

Automatic generation uses the following type of remote IP address configured from the local IP address, subnet mask, and remote node number (FINS node number).

$$\text{Remote IP address} = (\text{Local IP Address AND subnet mask}) \text{ OR remote node number}$$

- Automatic Generation Characteristics

Automatic generation has the advantage of easily understandable handling of FINS addresses and IP addresses. This method, however, does have the following limitations.

1. This method is applicable for addresses with the same net ID only.
2. The remote host ID is restricted to the range of FINS node numbers (1 to 126) (See note.).
3. The Ethernet Unit's host ID and node number must be set to the same value. Automatic generation is set as the default address conversion method, so it does not need to be set from the CX-Programmer.

Note: Up to 46 hosts can be set on the CX-Designer.

IP Address Table Method

Whereas the automatic generation method obtains the IP address from the FINS node number, the IP address table method converts the FINS node number to the IP address based on a preset conversion table (IP address table).

The IP address table is configured from the system settings using Support Software (CX-Programmer, SYSMAC-CPT, SYSMAC Support Software, or CV Support Software Ver.2 or later). Refer to the *SYSMAC CS/CJ Series Ethernet Unit Operation Manual* (Cat. No. W343) and *SYSMAC CVM1/CV Series Ethernet Unit Operation Manual* (Cat. No. W242) for details on setting methods.

Nodes that have different net IDs for different segments can also be registered.

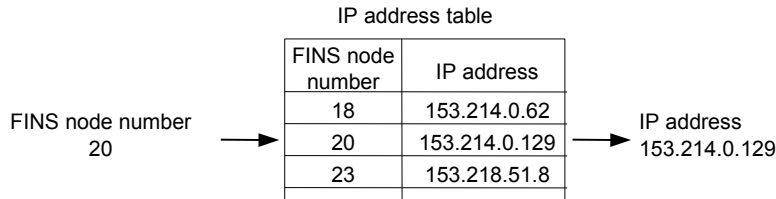

• **IP Address Table Method Characteristics**

The IP address table method simply prepares a conversion table, offering the advantage of allowing the correspondence between FINS node numbers and IP addresses to be created freely.

This method is, however, subject to restrictions. The IP address table allows registration of up to 32 corresponding addresses only, so no more than 32 nodes, including the local node, can be registered. If there is no correspondence, the remote FINS node number is not recognized.

IP Table + Automatic Generation Method

This method combines automatic generation and the IP address table method.

First refer to the IP address table, and if the required FINS address is included in the table, read the corresponding IP address. If the required FINS address is not included, calculate the IP address using the automatic generation method.

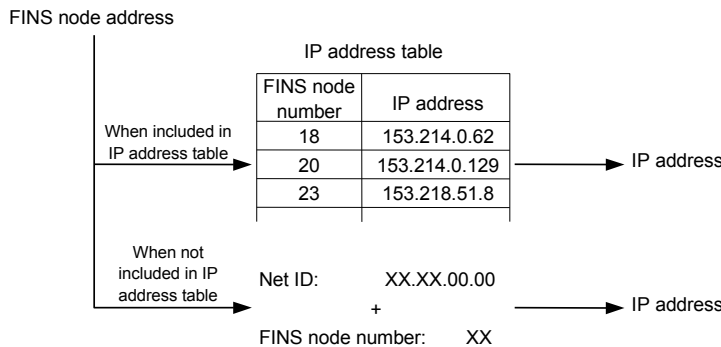

Setting Routing Tables

Routing tables define the communications path between the local node and the network containing the destination node. Routing tables are required to perform network communications. Routing tables consist of local network tables and remote network tables.

Local Network Tables

A local network tables contains the unit number and network address for every Communications Unit mounted at a node. If there is more than one Communications Unit at a node, each Unit will contain a local network table.

5-1 Connecting to Host Via Ethernet

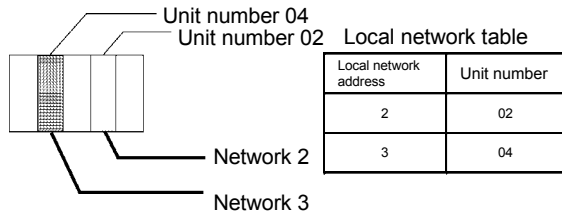

Remote Network Table

The remote network table provides the node and network address corresponding to the initial relay point (first point the data must pass) en route to a target network (end network) not directly connected to the local PLC. The table specifies the route from the relay point to the end network.

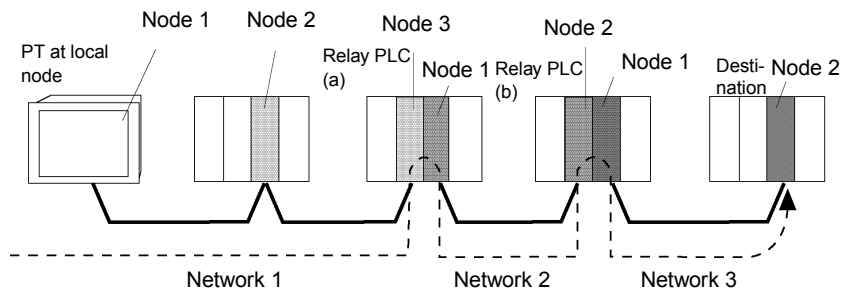

Relay Network Table for Local PT			Relay Network Table for PLC (a)			Relay Network Table for PLC (b)			Relay Network Table for Destination		
Destination network address	Relay network address	Gateway node address	Destination network address	Relay network address	Gateway node address	Destination network address	Relay network address	Gateway node address	Destination network address	Relay network address	Gateway node address
3	1	3	3	2	2	1	2	1	1	3	1

Meaning: To go to network 3, first go to node 3 of network 1.

Meaning: To go to network 3, first go to node 2 of network 2.

Meaning: To go to network 1, first go to node 1 of network 2.

Meaning: To go to network 1, first go to node 1 of network 3.

Routing tables are created using the CX-Programmer and then transferred to the host. Refer to the *CX-Programmer User Manual* for actual procedures.

The methods for setting each Unit are described next.

• CS-series PLCs

Precautions for Safe Use

- Always turn OFF the power to the PLC before setting the rotary switches.
- Create I/O tables for the CPU Unit when setting the unit number for the first time or changing settings.

CS1G/CS1H and CS1G/CS1H-H Ethernet Units:

CS1W-ETN01
 CS1W-ETN11
 CS1W-ETN21

Setting the Front Panel Switches

Setting Unit Numbers

Always set the unit numbers so that the unit numbers of other CPU Bus Units mounted to the CPU Unit are all unique.

Use a small screwdriver to set the rotary switches, being careful not to damage them.

The factory setting is 0.

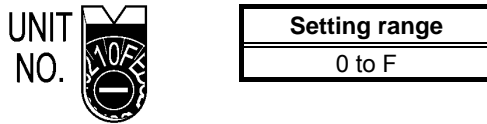

Setting Node Numbers

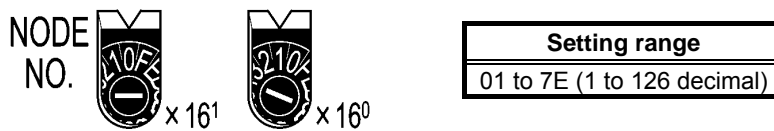

Set the upper digit using the left rotary switch and the lower digit using the right rotary switch.

The factory setting is 01.

When converting addresses using the automatic generation method, set the node number to the same value as that set for SW7 and SW8 of the local IP address setting switches, which are described on the following pages. If the same values cannot be set, the IP address table method or IP table + automatic generation method must be used to convert the addresses.

Setting the Rear Panel Switches

Setting Local IP Addresses

Set the local IP address for the Ethernet Unit using the eight hexadecimal rotary switches (local IP address setting switches), expressing each 4-bit value as a single hexadecimal digit. Set the IP address as a hexadecimal using the eight switches combining SW1 and SW2, SW3 and SW4, SW5 and SW6, and SW7 and SW8, as shown in the following diagram.

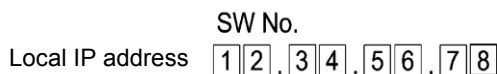
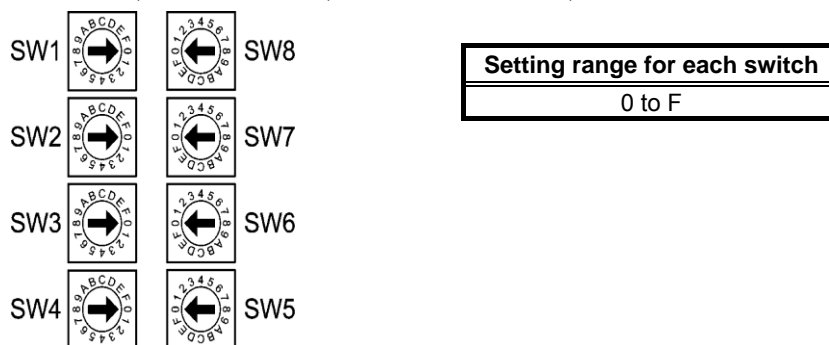

5-1 Connecting to Host Via Ethernet

Example: Setting 130.58.17.32 (Decimal)

This address will be 82.3A.11.20 in hexadecimal, so the switch would be set as shown in the following table.

Switch Setting	SW1	SW2	SW3	SW4	SW5	SW6	SW7	SW8
	8	2	3	A	1	1	2	0
Local IP address in hexadecimal	82		3A		11		20	
Local IP address in decimal	130		58		17		32	

-
- Reference**
- When using automatic generation (default method) for converting addresses, set the same value for the node number as that set for SW7 and SW8, and set the other host ID fields to 0. The ERC indicator will flash if the value of the IP address host ID does not correspond to the node number value.
 - Set the subnet mask in the CPU Bus Unit Setup Area using the CX-Programmer.
-

Ethernet Connectors

CS1W-ETN01

This is the connector used to connect the transceiver cable to the Ethernet.

- Electrical characteristics: Conforms to IEEE802.3 standards.
- Lock structure: Conforms to IEEE802.3 standards for Slide latches.

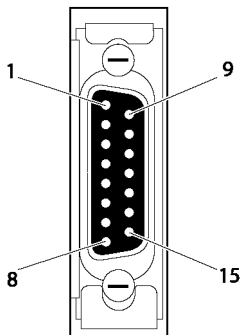

Connector Pin	Signal name	Abbreviation	Signal direction
1	Signal ground	GND	–
2	Collision detection signal +	COL+	Input
3	Send data +	TX+	Output
4	Signal ground	GND	–
5	Receive data +	RX+	Input
6	Voltage common Power ground (common with signal ground)	VC	–
7	Not used.	–	–
8	Signal ground	GND	–
9	Collision detection signal –	COL–	Input
10	Send data –	TX–	Output
11	Signal ground	GND	–
12	Receive data –	RX–	Input
13	Transceiver power	VP	–
14	Signal ground	GND	–
15	Not used.	–	–
Hood	Frame ground	FG	–

CS1W-ETN11
CS1W-ETN21

This is the connector used to connect the twisted-pair cable to the Ethernet.

- Electrical characteristics: Conforms to IEEE802.3 standards.
- Connector structure: RJ45 8-pin modular connector (conforms to ISO8877).

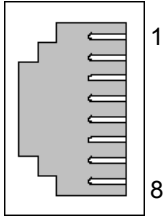

Con- nector Pin	Signal name	Abbreviation	Signal direction
1	Send data +	TD+	Output
2	Send data -	TD-	Output
3	Receive data +	RD+	Input
4	Not used.	-	-
5	Not used.	-	-
6	Receive data -	RD-	Input
7	Not used.	-	-
8	Not used.	-	-

• **CJ-series PLCs**

Precautions for Safe Use	<ul style="list-style-type: none"> • Always turn OFF the power to the PLC before setting the rotary switches. • Create I/O tables for the CPU Unit when setting the unit number for the first time or changing settings.
---------------------------------	--

CJ-series Ethernet Units:

CJ1W-ETN11
CS1W-ETN21

Setting the Front Panel Switches

Setting Unit Numbers

Always set the unit numbers so that the unit numbers of other CPU Bus Units mounted to the same CPU Unit are all unique.

Use a small screwdriver to set the rotary switches, being careful not to damage them.

The factory setting is 0.



Setting range
0 to F

Setting Node Numbers

Set the node numbers as hexadecimal values with the node number setting switch. Always set the node numbers so that other Ethernet Units connected to the same Ethernet network all have unique addresses. As long as the addresses are unique, they can be set between 01 and 7E (1 to 126 decimal).



Setting range
01 to 7E (1 to 126 decimal)



5-1 Connecting to Host Via Ethernet

Set the upper digit using the top rotary switch and the lower digit using the bottom rotary switch.

The factory setting is 01.

When using automatic generation to convert addresses, set the node number to the same value as that of the rightmost byte of the local IP address. If the same values cannot be set, the IP address table method or combination method must be used to convert the addresses.

Setting Local IP Addresses

For CJ-series Ethernet Units, set the local IP address from the CX-Programmer or other Support Software for the CPU Unit. Refer to the *SYSMAC CS/CJ Series Ethernet Unit Operation Manual* (Cat. No. W343) for details on setting methods.

Ethernet Connectors

CJ1W-ETN11
CS1W-ETN21

This is the connector used to connect the twisted-pair cable to the Ethernet.

- Electrical Characteristics: Conforms to IEEE802.3 standards.
- Connector Layout: RJ45 8-pin modular connector (conforms to ISO8877).

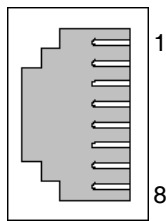

Con- nector Pin	Signal name	Abbreviation	Signal direction
1	Send data	TD+	Output
2	Send data –	TD–	Output
3	Receive data +	RD+	Input
4	Not used.	–	–
5	Not used.	–	–
6	Receive data –	RD–	Input
7	Not used.	–	–
8	Not used.	–	–

• CP-series PLCs (Except for the CP1E)

CP2E-Series Built-in Ethernet port

CP2E-N14
CP2E-N20
CP2E-N30
CP2E-N40
CP2E-N60

CP-series Ethernet Option Board

CP1W-CIF41

Setting Node Numbers

Set the node number to a unique value. Do not set it to the same value as any other Ethernet node on the same Ethernet network. Refer to the following manuals for the setting procedures.

CP1H: SYSMAC CP Series CP1H CPU Unit Operation Manual (Cat. No. W450)

CP1L: SYSMAC CP Series CP1L CPU Unit Operation Manual (Cat. No. W462)

CP2E: SYSMAC CP Series CP2E CPU Unit Software User's Manual (Cat. No. W614)

Setting Local IP Addresses

Use a Web browser to set the local IP address of the CP-series Ethernet Option Board. Refer to the following manuals for the setting procedures.

For CP2E Series Built-in Ethernet port, set the local IP address from the CX-Programmer or other supporting Software for the CPU Unit.

CP1H: SYSMAC CP Series CP1H CPU Unit Operation Manual (Cat. No. W450)

CP1L: SYSMAC CP Series CP1L CPU Unit Operation Manual (Cat. No. W462)

CP2E: SYSMAC CP Series CP2E CPU Unit Software User's Manual (Cat. No. W614)

Ethernet Connector

CP2E-N14/N20/N30/N40/N60 Built-in Ethernet port
CP1W-CIF41

This is the connector used to connect the twisted-pair cable to the Ethernet.

- Electrical Characteristics: Conform to the IEEE 802.3 standard.
- Connector Layout: RJ45 8-pin modular connector (conforms to ISO8877.)

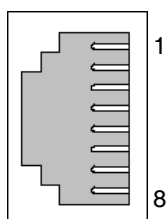

Connector Pin	Signal name	Abbreviation	Signal direction
1	Send data	TD+	Output
2	Send data –	TD–	Output
3	Receive data +	RD+	Input
4	Not used.	–	–
5	Not used.	–	–
6	Receive data –	RD–	Input
7	Not used.	–	–
8	Not used.	–	–

Reference • The CP1W-CIF41 cannot be used to connect an NS-series PT to a CP1E or CP2E PLC.

- To use the CP1W-CIF41 or CP2E series, the *Use CP1W-CIF41* Option must be selected in the Ethernet host settings of the communications settings in the CX-Designer. (System version 8.2 or higher and CX-Designer version 3.1 or higher are required.)
 - When connecting to the CP2E series, it is possible to connect only within the same network.
-

• CV/CVM1-series (-V□) PLCs

Unit for CV500-CPU01-V1, CV1000-CPU01-V1, CV2000-CPU01-V1, CVM1-CPU01-V2, CVM1-CPU11-V2, and CVM1-CPU21-V2 CPU Units:

CV500-ETN01

Setting Rotary Switches

Set the unit number and node number with the two rotary switches on the front of the Unit.

Switch Layout

The layout of the two switches is shown in the following diagram.

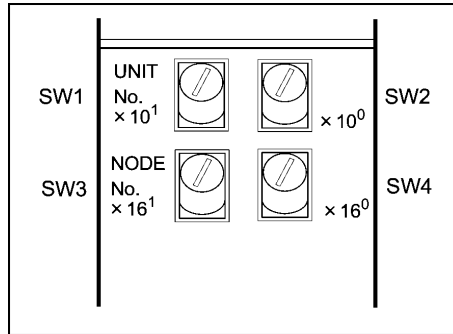

- Set the unit number using SW1 and SW2. Set the unit number so that it is different from other CPU Bus Units in the system.
- Set the node number using SW3 and SW4.

Setting Range

Each switch can be set within the following range.

Settings	Setting range
Unit number (SW1, SW2)	00 to 15 (decimal)
Node number (SW3, SW4)	01 to 7E hexadecimal (1 to 126 decimal)

Setting Unit Numbers

The unit number is used to identify each Unit when multiple CPU Bus Units are mounted to the CPU Unit.

Use the left switch (SW1) to set the ten's digit, and the right switch (SW2) to set the one's digit. Set between 00 and 15 decimal.

Setting Example

This example is for unit number 12.

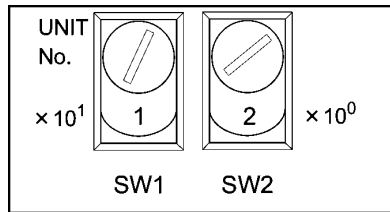

-
- Reference**
- The unit number cannot be set to a value more than 15. If the unit number is set to a value higher than 15, the ERC indicator in the display will light.
 - When more than one CPU Bus Unit is mounted to a single PLC, set each Unit with a unique unit number.
-

Setting Node Numbers

The node number is used to identify PLCs when more than one PLC is connected to the Ethernet. This setting is the node number used for FINS communications.

Use the left switch (SW3) to set the left digit as a hexadecimal, and the right switch (SW4) to set the right digit. The setting range is 01 to 7E hexadecimal (1 to 126 decimal).

Setting Example:

This example is for node number 29 (decimal).

$29 = 1 \times 16 + 13 = 1D$ (hexadecimal)

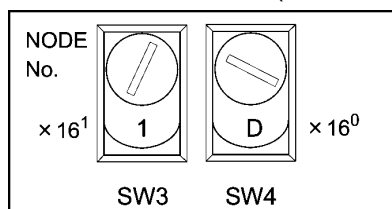

-
- Reference**
- The node number cannot be set to a value higher than 7E (126 decimal). If the node number is set to a higher value, an error will occur and the ERC indicator in the display will light.
 - Set the node numbers so that all the nodes in the same network are unique.
-

Setting IP Addresses for Ethernet Units

The IP address must also be set for Ethernet Units. Ethernet communications are not possible if the IP address of the Ethernet Unit is not set.

Set the IP address for the Ethernet Unit from the CPU Bus Unit Setup Area using Programming Devices (SYSMAC-CPT, SYSMAC Support Software, CV Support Software Ver. 2 or later, FIT20-MF501-V2, FIT10-MF501-V2, FIT20-MC601, or FIT20-MC701). Refer to the *SYSMAC CVM1/CV Series Ethernet Unit Operation Manual* (Cat. No. W242) for details on setting methods.

Ethernet Unit System

Set the system settings for the Ethernet Unit to operate on the Ethernet network as a node. Set the system settings using a Programming Device (SYSMAC-CPT, SYSMAC Support Software, CV Support Software Ver.2 or later, FIT20-MF501-V2, FIT10-MF501-V2, FIT20-MC601, or FIT20-MC701).

-
- Reference**
- For details on operating the Support Software, refer to the CPU Bus Unit Setup Area in the *SYSMAC Support Software Operation Manual: Networks* (Cat. No. W201) and *SYSMAC Support Software Operation Manual: CV Series* (Cat. No. W249).
 - Turn ON the power to the CPU Unit again after setting the system settings. The system settings are not enabled after setting them until the power has been turned ON again.
-

5-2 Connecting to the Host Using Controller Link

This section explains the method for connecting to the host using a Controller Link Interface Unit.

5-2-1 What Is a Controller Link Network?

A Controller Link Network is an FA Network that can send and receive large data packets flexibly and easily among the OMRON C200HX/HG/HE PLC Programmable Terminal (PTs), SYSMAC CS-series PLCs, CJ-series PLCs, CQM1H-series PLCs, C200HX/HG/HE PLCs, CVM1/CV-series PLCs, IBM PC/AT or compatible computers, and NS-series PTs. The Controller Link supports data links that enable data sharing and a message service that enables sending data and receiving data when required. Data link areas can be freely set to create a flexible data link system and effectively use data areas.

The network is connected using shielded twisted-pair cable or optical fiber cable. In addition, the Controller Link Network can transfer large quantities of data at high speed, so that it is possible to construct a wide-area network easily that supports from low-level systems to high. For details on data links and message service, refer to the *Controller Link Support Board Operation Manual (W307)*, *Controller Link Support Board for PCI Bus Operation Manual (Cat. No. W383)*, and the *Controller Link Unit Operation Manual (Cat. No. W309)*.

Note: An optical fiber cable is not available for NS-series PTs.

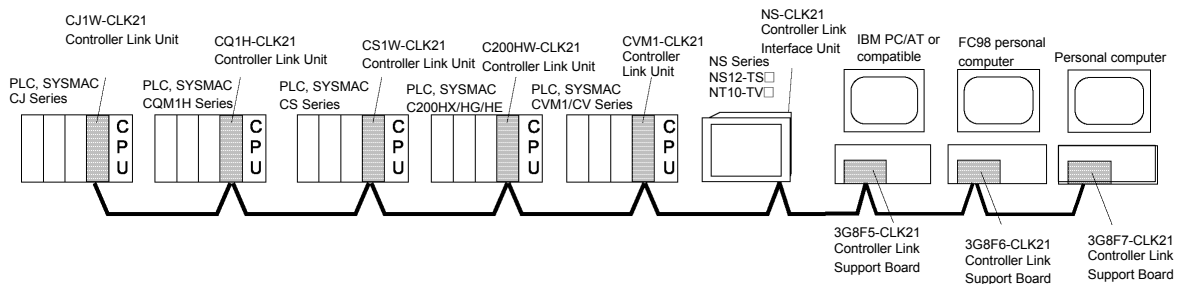

To connect the PT to the Controller Link, it is necessary to install a Controller Link Interface Unit on the PT. A Controller Link Interface Unit can be used only for the NS15, NS12 and NS10 NS-series PTs. Refer to *3-8 Installing the Controller Link Interface Unit* for the procedure for installing and wire the Controller Link Interface Unit.

When communicating by Controller Link, the network number, node number, routing tables, and data link tables must be set. Use the CX-Designer to set the settings. For details, refer to *System Settings and Project Properties* in the CX-Designer's Online Help.

Required Devices

To construct a Controller Link Network, the devices described in the following table are required.

Device	Model	Remarks
Controller Link Unit (See note.)	CVM1-CLK21 C200HW-CLK21 CS1W-CLK21 CQM1H-CLK21 CJ1W-CLK21	Required to connect PLC with Controller Link Network.
Controller Link Support Board (ISA Bus/PC98)	3G8F5-CLK21 3G8F6-CLK21	Required to connect IBM PC/AT or compatible computers with Controller Link Network.
Controller Link Support Board (PCI Bus)	3G8F7-CLK21	
Twisted-pair Cable	ESVC0.5×2C	Required to connect the PT, PLC, and IBM PC/AT or compatible computers. Use shielded twisted-pair cable.
Controller Link Wired Relay Terminal Block	CJ1W-TB101	Used as a relay terminal block for wires and can be used as required to facilitate replacement and maintenance of Controller Link Units and Boards after the communications system has been started.

Note: For details on the CPU Units that support connection to Controller Link Units, refer to *Appendix 8 Standard Models*.

5-2-2 Data Links

This section outlines data links and the method of setting data link tables when using data links. For details, refer to the *Controller Link Support Board Operation Manual (W307)*, *Controller Link Unit Operation Manual (Cat. No. W309)*, and the *Controller Link Support Board for PCI Bus Operation Manual (Cat. No. W383)*.

What Are Data Links?

Data links automatically exchange preset data between nodes (i.e., between PLCs, between a PLC and an IBM PC/AT or compatible computer, or between a PLC and an NS-series PT). Data links can be freely created for CS-series PLCs, C200HX/HG/HE PLCs, CVM1, CV-series PLCs, CJ-series PLCs, CQM1H-series PLCs, and NS-series PTs.

Two data link areas, area 1 and area 2, can be set for each node. Data links can be set in either of the following ways.

- Data link areas can be set by inputting data link tables through the Controller Link Support Software. Data link tables are created to define the data links. These tables enable free allocation of data link areas.
- Data links can be set automatically from a Programming Device. With automatically set data links, all link areas are the same size.

Automatic setting and manual setting cannot be used together in the same network.

The following rules apply to these methods of setting data links.

1. Data links are enabled concurrently for area 1 and area 2.
2. Separate settings (data link start words and send area size) are made in area 1 and area 2. The sequences of send and receive words are the same in area 1 and area 2.
3. Not all nodes must participate in the data links.

5-2 Connecting to the Host Using Controller Link

Example 1: The order of send and receive nodes is free.

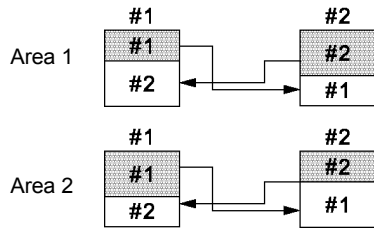

Example 2: Some nodes can send data without receiving data.

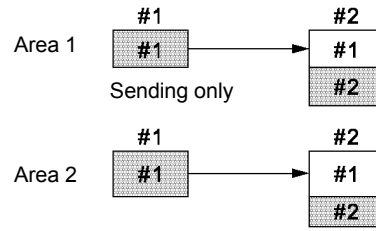

Example 3: Some nodes can receive data without sending data.

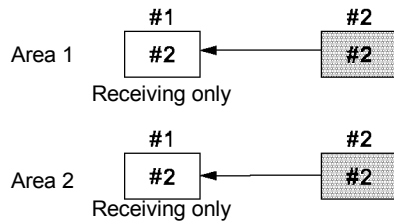

Example 4: A node can receive a specified number of words from the beginning of an area.

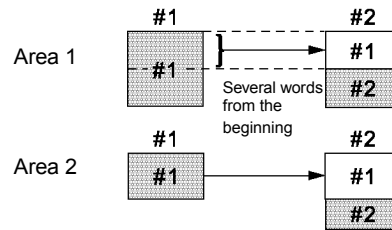

Setting Data Link Tables

To perform data links, data link tables are required. Set data link tables by following the steps below.

1. Set data link tables using the CX-Net (Network Configurations Tool).

Data link tables are created to define data links. These tables must be set for each node participating in data links. Refer to the manual for CX-Programmer for the method of setting.

The following table shows the items and setting range for data link tables in the Controller Link Support Board mounted on the PT.

Setting item		Setting range
PLC		Set as a "NSB."
Node		1 to 32 Set the address of the refresh nodes.
First data link status word		If a number is set, it will be invalid because the first word to store data link status is fixed. Set "-".
Area 1	Data link start word (See note.)	\$B0 to \$B32767 \$W0 to \$W24575 Use CIO for \$B and D for \$W in the CX-Net. The same area cannot be set for both area 1 and area 2. Set different areas.
	Number of words	<ul style="list-style-type: none"> Remote nodes: 0 to the number of source words Set the number of words to be received Local nodes: 0 to 1000 Set the number of words to be transmitted The total number of words in area 1 and area 2 in each node must not exceed 1,000. The number of words in both area 1 and area 2 in each node must not be set to 0.
	Offset	<ul style="list-style-type: none"> Remote nodes: 0 to one less than number of source words Set offset for data to be received Local nodes: Cannot be set. This setting is not required if an offset is not used.
Area 2	Data link start word (See note.)	\$B0 to \$B32767 \$W0 to \$W24575 Use CIO for \$B and D for \$W in the CX-Net. The same area cannot be set for both area 1 and area 2. Set different areas.
	Number of words	<ul style="list-style-type: none"> Remote nodes: 0 to the number of source words Set the number of words to be received Local nodes: 0 to 1000 Set the number of words to be transmitted The total number of words in area 1 and area 2 in each node must not exceed 1,000. The number of words in both area 1 and area 2 in each node must not be set to 0.
	Offset	<ul style="list-style-type: none"> Remote nodes: 0 to one less than number of source words Set offset for data to be received Local nodes: Cannot be set. This setting is not required if an offset is not used.

**Precautions
for Safe Use**

- The following examples show how to change CIO and D addresses to \$B and \$W addresses.
1. Changing to \$B addresses:

\$B address = Word in CIO address (0 to 2047) × 16 + Bit in CIO address (00 to 15)

Example: If the CIO address is 00100.04, \$B address = 100 × 16 + 4 = \$B1604.

Word Bit
 2. Changing to \$W addresses:

\$W address = D address (0 to 24575)

Example: If the D address is D00100, \$W address = \$W100.

 - The total number of words set in area 1 and area 2 must not exceed 32,000.
 - Always delete the data link tables if the node does not participate in data links.

Save the data link tables after setting the above items.

2. Set data link tables for the PT side on the CX-Designer

The two setting methods below can be used. Use the appropriate method for the application.

 - 1) Specifying data link tables with CX-Designer:

If the data link tables are set from the CX-Designer, then they cannot be changed via a network. Even if they are temporarily changed from the CX-Server or Controller Link Support Software, they will return to the tables set from the CX-Designer the next time the PT is started. To change the data link tables when they have been set from the CX-Designer, it is necessary to retransfer the project or setting file to the PT.

Select **PT – Communication Setting – Controller Link** in the CX-Designer and specify the data link tables created in step 1. For details on specifying the data link table's settings file, refer to *System Settings and Project Properties* in the CX-Designer's Online Help.
 - 2) Setting data link tables across a network:

To do so, transfer the data link tables in the Controller Link Interface Unit from the CX-Server or Controller Link Support Software, and do not specify data link tables from the CX-Designer. If data link tables are set via a network, then they can later be changed via a network as required. For details on the transfer method, refer to the *CX-Net Operation Manual* (Cat. No. W361) and the *Controller Link Support Software Operation Manual* (Cat. No. W369).
3. Transfer the project created on CX-Designer to the PT.

Starting and Stopping Data Links

The PT starts and stops data links according to the status of the data links when participating in the network. If the data links are started when entering the network, the PT will start its data links. If network has stopped data links, the PT will not start data links. The PT cannot control starting/stopping data links independently. Control starting/stopping data links on the Controller Link network using the startup node or CX-Server.

**Precautions
for Safe Use**

- The data link mode (manual setting or automatic setting) and data link method are determined according to the data link setting in the startup node. In the startup node, set the data link tables if manual settings are being used and data link automatic setting parameters if automatic settings are being used. If the settings are incorrect, the data links will not start.

Caution

- Check the following items before starting data links.
 1. Manually Set Data Links
Check the data link tables in each node participating in the data link to see that they are correct. Be sure that data link tables are deleted from nodes that are not participating in the data links.
 2. Automatically Set data Links
Be sure that the correct DM parameters have been set in the data link startup node.
If incorrect data link tables or parameters are set, injury may result due to unexpected operation of the system.
- Even if the correct data link tables or parameters have been set, do not start or stop data links before verifying that there will be no adverse influence on the system.



Setting Routing Tables

Routine tables that define the communications path from the local node to the network connected to the destination. Routine tables must be set for the following items.

- Local node
- All relay nodes that are included for the communication path from local node to the destination.

Make settings for routing tables on the CX-Designer. For details on setting routing tables, refer to *System Settings and Project Properties* in the CX-Designer's Online Help.

For details on setting routing tables for the PLC, refer to *Section 7 System Settings* in the *CX-Designer Operation Manual*.

5-2-3 Troubleshooting Using Indicators

The errors indicated by indicators on the Controller Interface Unit and remedies are explained in this section.

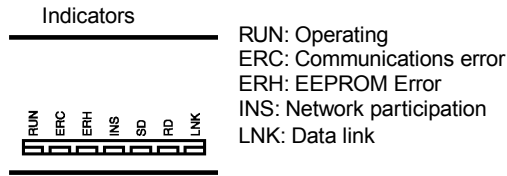

Troubleshooting with RUN, ERC, ERH, and INS Indicators

The RUN, ERC, ERH, and INS indicators can be used to check whether the Controller Link Interface Unit and network participation are operating normally.

Precautions for Safe Use

- Always turn OFF the power to the PT before performing any of the following operations.
- Connecting/Disconnecting a Board or a connector.
- Securing a Board or a connector.
- Setting hardware switches.

Indicators				Probable cause	Remedy
RUN	ERC	ERH	INS		
Lit	Not lit	Not lit	Lit	The Unit operating normally. Network participation normal.	
Not lit	Lit	—	—	Controller Link Interface Unit is faulty.	If ERC indicator lights even after mounting on another PT, replace the Controller Link Interface Unit
Not lit	Not lit	Not lit	Not lit	Power is not being supplied to PT normally.	Check the power supply voltage and supply at the recommended voltage.
				The Controller Link Interface Unit has become loose.	Secure the Controller Link Interface Unit firmly.
				Controller Link Interface Unit is mounted in the wrong slot.	Refer to 3-8 <i>Installing the Controller Link Interface Unit</i> , and mount the Board correctly.
				Controller Link Interface Unit is faulty.	If indicators do not light when the Board is mounted on another PT, replace the Controller Link Interface Unit
Lit	Lit	—	Not lit	The same node address is being used in the same network.	Reset so that each node address is used only once within the same network.

Indicators				Probable cause	Remedy
RUN	ERC	ERH	INS		
Lit	-	Lit	-	Routing table setting error.	Remake and set the routing tables correctly, referring to <i>System Settings and Project Properties</i> in the CX-Designer's Online Help. When the routing tables are not being used, delete the routing tables.
				EEPROM error.	Send a FINS command to the Controller Link Interface Unit to read status, correct the data where the error has occurred, and reset the Board. If the error occurs again, replace the Controller Link Interface Unit.
Lit	-	-	Not lit	Terminating resistance is not set correctly.	Turn ON the terminating resistance at the nodes at both ends of the network and turn it OFF at all other nodes.
				Cables are not connected correctly.	Check the cable connections and reconnect correctly.
				The node address is larger than the maximum node address set for the network parameters.	Either reset the maximum node address using Controller Link Support Software or reset the node address to below the maximum.
				No other nodes exist.	Ensure that 2 or more nodes exist within the Network.
				No nodes have been set as polling node.	Set the polling node using the CX-Server.
				The set baud rate is different from other nodes.	Reset the baud rate for the Controller Link in the CX-Designer's Communication Setting. For details on setting the baud rate, refer to <i>System Settings and Project Properties</i> in the CX-Designer's Online Help.

Troubleshooting with LNK Indicator

- Data Links Cannot Be Started

The following table describes the LNK indicator and remedies when a data link cannot be started.

Starting a data link depends on the Controller Link Interface Unit operating normally and participating in the network. Refer to *Troubleshooting with RUN, ERC, ERH, and INS Indicators* earlier in this section and check operation before using the following table.

Indicator	Probable cause	Remedy
LNK		
Lit	Data link operating normally.	-----
Flashing	There is an error in the data link tables.	If ERH or ERR indicator is lit, reset the data link tables.
	When manual setting is used, either data link tables have not been created for the startup node or there is an error in the data link tables.	Create the data link tables for the startup node using the CX-Server.
Not lit	Manually set data links are already operating on the same Network.	Set data link tables for the local node.
	Automatically set data links are already operating on the same Network.	Stop the data links, review and set the parameters in the startup node's DM area, and then restart. The PT cannot be the startup node for automatic settings. Settings must be performed at Controller Link Unit on the PLC.

- Node Cannot Participate in Data Links

The following table describes the LNK indicator and remedies when a Node cannot participate in the data links.

Data link participation in the network depends on the Controller Link Interface Unit operating normally and participating in the network. Refer to *Troubleshooting with RUN, ERC, ERH, and INS Indicators* earlier in this section and check operation before using the following table.

Indicator	Probable cause	Remedy
LNK		
Lit	Data Link operating normally.	-----
Flashing	When manual setting is used, there is an error in the data link table.	Reset data link tables using the CX-Server.
Not lit	When manual setting is used, there are no Data Link Tables set for the local node.	Set the data link tables for the local node.
	When automatic setting is used, the setup node is not set to participate in the data links.	Stop the data links, remake and set the parameters in the Startup node's DM Area, and then restart the data links. Setting must be performed at PLC on the Controller Unit side, because the Controller Link Interface Unit cannot be the startup node for automatic settings. For details, refer to the <i>Controller Link Units Operation Manual</i> .

5-3 Connecting to Host via EtherNet/IP

5-3-1 What is EtherNet/IP?

EtherNet/IP is a multi-vendor industrial network protocol that uses Ethernet. The specification is an open standard managed by the ODVA (Open DeviceNet Vendor Association), as is DeviceNet, and it is used for a variety of industrial devices.

NS-series PTs can communicate with CS/CJ-series EtherNet/IP Units and CJ2H-CPU□□-EIP, CJ2M-CPU3□ and NJ□01-□□00, NX□0□-□□□□, or NX1P2-□□□□ Units with built-in EtherNet/IP ports.

Also, it is possible to perform tag message communications when using a CPU Unit with a built-in EtherNet/IP port. These CPU Units contain a tag name server, so if tag names and an address table are stored in advance in the CPU Unit, it is possible to perform access from the NS-series PT using only the tag names.

The following NS-series PTs and systems versions support EtherNet/IP.

Model	NS15-TX01□-V2, NS12-V2, NS10-V2, NS8-V2, NS5-SQ1□-V2, NS5-TQ1□-V2, NS5-MQ1□V2
System version	CS/CJ Series: Version 8.0 or higher NJ101 Series: Version 8.6 or higher NJ301 Series: Version 8.6 or higher NJ501 Series: Version 8.5 or higher NX701 Series: Version 8.9 or higher NX102 Series: Version 8.96 or higher NX1P2 Series: Version 8.93 or higher

The following NS-series PTs and Controllers can be connected using EtherNet/IP.

Series name	Using the built-in board	Using an EtherNet/IP Unit	EtherNet/IP Unit
CS Series		CS1G-CPU□□(-V1) CS1G-CPU□□H CS1H-CPU□□(-V1) CS1H-CPU□□H CS1D-CPU□□H	CS1W-EIP21
CJ Series	CJ2H-CPU□□-EIP CJ2M-CPU3□	CJ1H-CPU□□H CJ1H-CPU□□H-R CJ1G-CPU□□H CJ1M-CPU□□ CJ2H-CPU□□(-EIP) CJ2M-CPU□□	CJ1W-EIP21
NJ Series	NJ101-□□□□ NJ301-□□□□ NJ501-□□□□	NJ101-□□□□ NJ301-□□□□ NJ501-□□□□	CJ1W-EIP21 (See note 1.)
NX Series (See note 2.)	NX701-□□□□ NX102-□□□□ NX1P2-□□□□	-	-

Note 1: The NJ-series Troubleshooter cannot be used. The following unit versions are required.

NJ-series CPU Unit: Unit version 1.01 or later

EtherNet/IP Unit: Unit version 2.1 or later

Note 2: Please select the SYSMAC-NJ for Host type to be set to the CX-Designer when connecting to the NX Series

5-3-2 Selecting Network Configuration Devices

Devices Required to Construct a Network

The basic configuration for an EtherNet/IP system includes one Ethernet switch to which nodes are attached in star configuration using twisted-pair cable.

Configuration Example

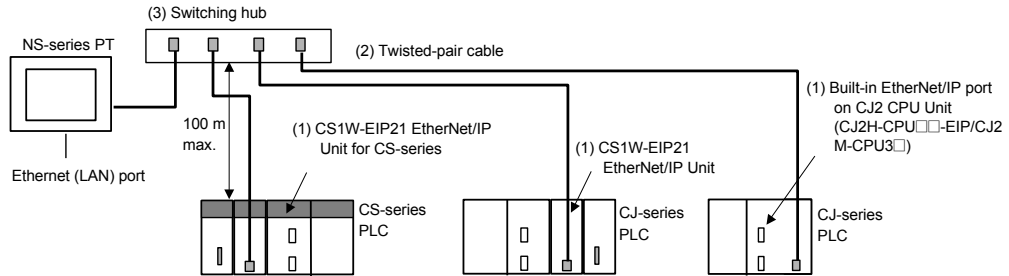

The following devices are required to configure a network using an EtherNet/IP Unit and must be purchased separately. Prepare the devices in advance.

Network device	Function
(1) Per Node NX701-□□□□/NX102-□□□□/NX1P2-□□□□ NX Series CPU Unit (built-in EtherNet/IP port) NJ501-□□□□/NJ301-□□□□/ NJ-series CPU Unit (built-in EtherNet/IP port) CJ2H-CPU□□-EIP or CJ2M-CPU3□ CJ2 CPU Unit (built-in EtherNet/IP port) CJ-series CJ1W-EIP21 EtherNet/IP Unit CS-series CS1W-EIP21 EtherNet/IP Unit	These Units are used to connect to an EtherNet/IP network.
(2) Twisted-pair cable	The twisted-pair cable has a RJ45 Modular Connector at each end. This cable is used to connect the built-in EtherNet/IP port or EtherNet/IP Unit to a Ethernet switch. Use an STP (shielded twisted-pair) cable of category 5, 5e, or higher.
(3) Ethernet switch	This is a relay device that connects multiple nodes in a star LAN.

Recommended Network Devices

The following table shows the devices recommended for use with the EtherNet/IP.

Ethernet Switches

Ethernet Switches from OMRON

Name	Model	Specifications	OK: Supported, ---: Not supported.		Inquire
		Description	Number of ports	Failure detection output	
Ethernet Switch	W4S1-03B	Packet priority control (QoS): EtherNet/IP control data priority	3	---	OMRON
	W4S1-05B		5	---	

	W4S1-05C	Failure detection: Broadcast storm, LSI error detection, 10/100Base-TX, Auto negotiation	5	OK	
--	----------	--	---	----	--

Ethernet Switches from Other Companies

Manufacturer	Model	Inquire
Cisco Systems, Inc.	Consult the manufacturer.	Cisco Systems, Inc.
CONTEC USA Inc.	Consult the manufacturer.	Contec USA, Inc.
Phoenix Contact USA	Consult the manufacturer.	Phoenix Contact

Twisted-pair Cables (100Base-TX) and Connectors (Modular Plugs and STP Plugs)

Product	Manufacturer	Model	Inquire	
Sizes and conductor pairs: AWG 24 × 4 pairs	Cables	Tonichi Kyosan Cable, Ltd.	NETSTAR-C5E SAB 0.5 · 4P	Kanetsu Planning Department
		Kuramo Electric Co., Ltd.	KETH-SB	Kuramo Electric Co., Ltd.
		SWCC Showa Cable Systems Co. Ltd.	FAE-5004	SWCC Showa Cable Systems Co. Ltd.
	RJ45 Connectors	Panduit Corporation	MPS588	Panduit Corporation, Japan Branch, Osaka Sales Office
Sizes and conductor pairs: AWG 22 × 2 pairs	Cables	Kuramo Electric Co., Ltd.	KETH-PSB-OMR*	Kuramo Electric Co., Ltd.
	RJ45 Assembly Connectors	OMRON	XS6G-T421-1*	OMRON Corporation, Customer Support Center
Sizes and conductor pairs: 0.5 mm × 4 pairs	Cables	Fujikura Ltd.	F-LINK-E 0.5mm · 4P	Kanetsu Planning Department
	RJ45 Connectors	Panduit Corporation	MPS588	Panduit Corporation, Japan Branch, Osaka Sales Office

* We recommend using combinations of the above cables and connectors.

Boots

Manufacturer	Model	Inquires
TSUKO	MK Boots (IV) LB	TSUKO

Ethernet Switch Types

Unmanaged Layer 2 (L2) Ethernet Switches

These Ethernet switches use the Ethernet MAC address to switch ports. Ordinary Ethernet switches have this function. Ethernet switch functions and settings cannot be changed.

Managed Layer 2 (L2) Ethernet Switches

These Ethernet switches use the Ethernet MAC address to switch ports. Ethernet switch functions and settings can be changed with special software tools for Ethernet switches running on a network node. You can also collect analytical data. These Ethernet switches provide more-advanced functions than unmanaged layer 2 Ethernet switches.

Ethernet Switch Functions

This section describes the Ethernet switch functions that are important for an EtherNet/IP network. For a built-in EtherNet/IP port, consider whether the Ethernet switch supports these functions when you select the Ethernet switch.

- Multicast filtering
- QoS (Quality of Service) for TCP/UDP port numbers (L4)

Multicast Filtering

Multicast filtering transfers multicast packets to the specific nodes only. This function is implemented in the Ethernet switch as IGMP snooping or GMRP. "Specific nodes" are nodes equipped with an IGMP client that have made transfer requests to the Ethernet switch. (OMRON built-in EtherNet/IP ports are equipped with an IGMP client.) When the Ethernet switch does not use multicast filtering, multicast packets are sent to all nodes, just like broadcast packets, which increases the traffic in the network. Settings must be made in the Ethernet switch to enable this function. There must be enough multicast filters for the network.

QoS (Quality of Service) Function for TCP/UDP Port Numbers (L4)

This function controls the priority of packet transmissions so that packets can be sent with higher priority to a particular IP address or TCP (UDP) port. The TCP and UDP protocols are called transport layer protocols, leading to the name L4 (layer 4) QoS function.

Support for the above two functions is as follows for the different types of Ethernet switches.

Ethernet switch type	Multicast filtering	L4 QoS	Remarks
Unmanaged L2 Ethernet switches	None	None	---
Managed L2 Ethernet switches	Provided.	Provided.	Both functions must be set with a special software tool.
OMRON W4S1-series Ethernet Switches	None	Provided.	L4 QoS is set with a switch. No software tool is necessary.

5-3-3 Network Installation

Basic Installation Precautions

- Take the greatest care when you install the Ethernet system. Be sure to follow ISO 8802-3 specifications. Be sure you understand them before attempting to install an Ethernet System.
- Unless you are already experienced in installation of communications systems, we strongly recommend that you employ a professional to install your system.
- Do not install Ethernet equipment near sources of noise. If a noisy environment is unavoidable, take adequate measures against noise interference, such as installation of network components in metal cases or the use of optical cable in the system.

Precautions on Laying Twisted-pair Cable

- Noise immunity may be reduced by ground loops, which can occur due to improper shield connections and grounding. Ground the shield at one location, as shown in the following diagram.
- Do not connect the shield to the PT's connector.
- If a cable connects two Ethernet switches, connect the shield at only one end.

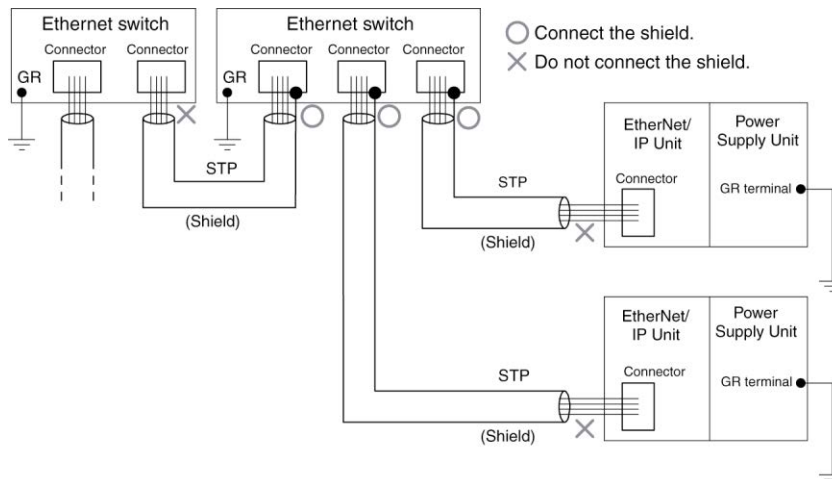

- Press the cable connector in firmly until it locks into place at both the Ethernet switch and the EtherNet/IP port.
- Do not lay the twisted-pair cable together with high-voltage lines.
- Do not install the network or network devices near devices that generate noise.
- Do not install the network or network devices in locations subject to high temperatures or high humidity.
- Do not install the network or network devices in locations subject to excessive dirt and dust or to oil mist or other contaminants.

Ethernet Switch Installation Environment Precautions

- Do not ground the Ethernet switch in the same location as a drive-system component, such as an inverter.
- Always use a dedicated power supply for the Ethernet switch's power supply. Do not use the same power supply for other equipment, such as an I/O power supply, motor power supply, or control power supply.
- Before installation, check the Ethernet switch's environmental resistance specifications, and use a Ethernet switch that is appropriate for the ambient conditions. Contact the Ethernet switch manufacturer for details on Ethernet switch's environmental resistance specifications.

Ethernet Switch Connection Methods

- Connect two Ethernet switches to each other as follows:
Connect an MDI port to an MDI-X port with a straight cable.
Connect two MDI ports or two MDI-X ports with a cross cable.

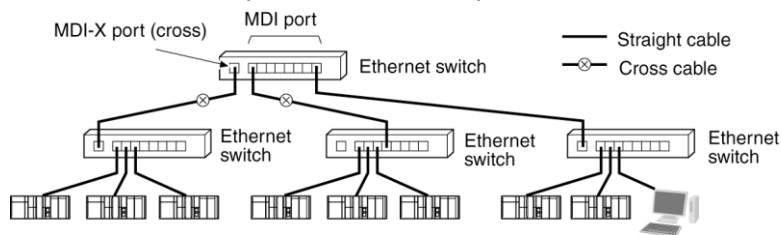

- Some Ethernet switches can automatically distinguish between MDI and MDI-X. When this kind of Ethernet switch is used, straight cable can be used between Ethernet switches.

5-3-4 Host Types and Settings

Units that are used for EtherNet/IP communications vary according to the type and series of OMRON PLC used.

When connecting an EtherNet/IP Unit, check the series and type of the PLC that it will be connected to and the model of the Unit that is mounted to the PLC.

For details on the hosts that can be connected to NS-series PTs via the EtherNet/IP, refer to *Appendix 8 Standard Models*.

Refer to the following manual for host parameter settings: SYSMAC CS/CJ-series EtherNet/IP Units Operation Manual (Cat. No. W465), SYSMAC CJ-series CJ2 CPU Units Operation Manual (Cat. No. W472), NJ/NX-series CPU Unit Built-in EtherNet/IP Port User's Manual (Cat. No. W506), or CJ-series EtherNet/IP Units Operation Manual for NJ-series CPU Unit (Cat. No. W495).

Connecting to a CJ-series CPU Unit

Precautions for Safe Use

- Always turn OFF the power to the PLC before setting the rotary switches.
- Create I/O tables for the CPU Unit when setting the unit number for the first time or changing settings.

CJ-series CPU Unit (Built-in EtherNet/IP Port):

CJ2H-CPU□□-EIP

CJ2M-CPU3□

Setting Local IP Addresses

Set the local IP address with the CX-Programmer or other Support Software.

Refer to the *SYSMAC CS/CJ Series EtherNet/IP Units Operation Manual* (Cat. No. W465) for details on setting methods.

Setting the Front Panel Switches

Setting the Unit Number

Set a unique unit number for the CJ2 CPU Unit built-in EtherNet/IP port. The same unit number cannot be used by any other CPU Bus Unit connected to the CJ2 CPU Unit.

Use a small screwdriver to make the setting, and be sure not to damage the rotary switch. The unit number is factory-set to 0.

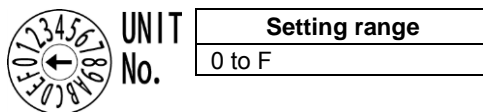

Node Address Setting Switches

Set a FINS address for the built-in EtherNet/IP port. With the FINS communications service, multiple EtherNet/IP Units (including the CJ2 Unit built-in EtherNet/IP port) connected by Ethernet are identified by their node addresses. Using the node address switches, set a unique node address in hexadecimal. The same node address cannot be used by any other EtherNet/IP Unit or Ethernet Unit connected on the same Ethernet network.

As long as it does not duplicate any other address, the node address can be set from 01 to FE (1 to 254 in decimal).

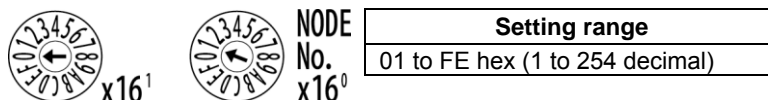

Note: The node address is factory-set to 01. With the default setting, the values set on these switches

5-3 Connecting to Host via EtherNet/IP

become the last two digits of the built-in EtherNet/IP port's IP address. The default IP address is 192.168.250.node_address. With the factory-set node address of 01, the default IP address is 192.168.250.1. The node address can be set to any number in the setting range (01 to FE), as long as the same address is not set on another node in the network.

Ethernet Connectors

This is the connector used to connect the twisted-pair cable to the Ethernet.

- Electrical Characteristics: Conforms to IEEE802.3 standards.
- Connector Layout: RJ45 8-pin modular connector (conforms to ISO 8877).

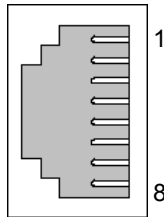

Connector Pin	Signal name	Abbreviation	Signal direction
1	Send data	TD+	Output
2	Send data -	TD-	Output
3	Receive data +	RD+	Input
4	Not used.	-	-
5	Not used.	-	-
6	Receive data -	RD-	Input
7	Not used.	-	-
8	Not used.	-	-

Connecting to an NJ/NX-series CPU Unit

- NJ101-□□□□
- NJ301-□□□□
- NJ501-□□□□
- NX701-□□□□
- NX102-□□□□
- NX1P2-□□□□

Setting Local IP Address

Set the local IP address with the Sysmac Studio or other Support Software. Refer to the *NJ/NX-series CPU Unit Built-in EtherNet/IP Port User's Manual* (Cat. No. 506) for details on setting methods.

Ethernet Connectors

This is the connector used to connect the twisted-pair cable to the Ethernet.

- Electrical Characteristics: Conform to the IEEE 802.3 standard.
- Connector Layout: RJ45 8-pin modular connector (conforms to ISO 8877.)

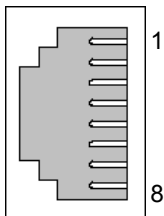

Connect-or Pin	Signal name	Abbreviation	Signal direction
1	Send data	TD+	Output
2	Send data -	TD-	Output
3	Receive data +	RD+	Input
4	Not used.	-	-
5	Not used.	-	-
6	Receive data -	RD-	Input
7	Not used.	-	-
8	Not used.	-	-

Connecting to a CS-series EtherNet/IP Unit

Precautions for Safe Use

- Always turn OFF the power to the PLC before setting the rotary switches.
- Create I/O tables for the CPU Unit when setting the unit number for the first time or changing settings.

CS-series EtherNet/IP Unit:

CS1W-EIP21

Setting the Front Panel Switches

Setting Unit Numbers

Always set the unit numbers so that the unit numbers of other CPU Bus Units mounted to the same CPU Unit are all unique.

Use a small screwdriver to set the rotary switches, being careful not to damage them.

The factory setting is 0.

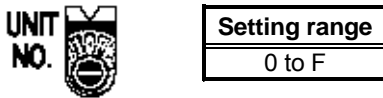

Setting Node Numbers

Use the node address switches to set the node address to a unique hexadecimal value. Do not set it to the same value as any other EtherNet/IP Unit or built-in port on the same EtherNet/IP network. As long as it does not duplicate the address of any other EtherNet/IP Unit or built-in port, the node address can be set from 01 to 7E hex (1 to 126 decimal).

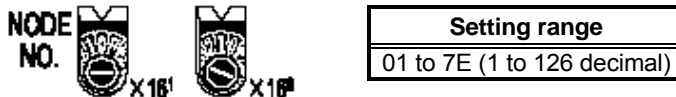

Set the upper digit using the left rotary switch and the lower digit using the right rotary switch. The factory setting is 01.

When using automatic generation to convert addresses, set the node number to the same value as that of the rightmost byte of the local IP address. If the same values cannot be set, the IP address table method or combination method must be used to convert the addresses.

Setting Local IP Addresses

Set the local IP address with the CX-Programmer or other Support Software.

For the setting procedure, refer to the *SYSMAC CS/CJ-series EtherNet/IP Units Operation Manual* (Cat. No. W465).

Ethernet Connectors

This is the connector used to connect the twisted-pair cable to the Ethernet.

- Electrical Characteristics: Conforms to IEEE802.3 standards.
- Connector Layout: RJ45 8-pin modular connector (conforms to ISO 8877).

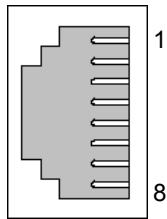

Con- nector Pin	Signal name	Abbreviation	Signal direction
1	Send data	TD+	Output
2	Send data –	TD–	Output
3	Receive data +	RD+	Input
4	Not used.	–	–
5	Not used.	–	–
6	Receive data –	RD–	Input
7	Not used.	–	–
8	Not used.	–	–

Connecting to a CJ-series EtherNet/IP Unit or NJ-series CPU Unit

**Precautions
for Safe Use**

- Always turn OFF the power to the PLC before setting the rotary switches.
- Create I/O tables for the CPU Unit when setting the unit number for the first time or changing settings.

CJ-series EtherNet/IP Unit:

CJ1W-EIP21

Setting the Front Panel Switches

Setting Unit Numbers

Always set the unit numbers so that the unit numbers of other CPU Bus Units mounted to the same CPU Unit are all unique.

Use a small screwdriver to set the rotary switches, being careful not to damage them.

The factory setting is 0.



Setting range
0 to F

Setting Node Numbers

Use the node address switches to set the node address to a unique hexadecimal value. Do not set it to the same value as any other EtherNet/IP Unit or built-in port on the same EtherNet/IP network. As long as it does not duplicate the address of any other EtherNet/IP Unit or built-in port, the node address can be set from 01 to 7E hex (1 to 126 decimal).



Setting range
01 to 7E (1 to 126 decimal)

Set the upper digit using the left rotary switch and the lower digit using the right rotary switch.

The factory setting is 01.

When using automatic generation to convert addresses, set the node number to the same

value as that of the rightmost byte of the local IP address. If the same values cannot be set, the IP address table method or combination method must be used to convert the addresses.

Setting Local IP Addresses

Set the local IP address with the CX-Programmer or other computer support software. Refer to the *EtherNet/IP Unit Operation Manual* (Cat. No. W465) or the *CJ-series EtherNet/IP Units Operation Manual for NJ-series CPU Unit* (Cat. No. W495) for details on setting methods.

Ethernet Connectors

This is the connector used to connect the twisted-pair cable to the Ethernet.

- Electrical Characteristics: Conforms to IEEE802.3 standards.
- Connector Layout: RJ45 8-pin modular connector (conforms to ISO8877).

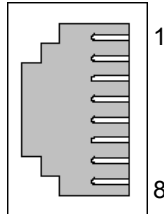

Connector Pin	Signal name	Abbreviation	Signal direction
1	Send data	TD+	Output
2	Send data -	TD-	Output
3	Receive data +	RD+	Input
4	Not used.	-	-
5	Not used.	-	-
6	Receive data -	RD-	Input
7	Not used.	-	-
8	Not used.	-	-

5-3 Connecting to Host via EtherNet/IP

Section 6

System Menu Operations

This section describes the methods for operating the System Menu.

This section also provides details on functions that are useful for NS-series PT applications and for system maintenance.

6-1	Operating Modes and System Menu.....	6-4
6-1-1	Mode Configuration	6-4
6-1-2	System Menu Configuration	6-4
6-1-3	Overview of Menu Items.....	6-5
6-1-4	Using the System Menu	6-8
6-2	Initializing and Saving Data and Removing the Memory Card.....	6-11
6-2-1	Screen Data Area Format	6-12
6-2-2	Initializing or Saving the Alarm/Event History.....	6-13
6-2-3	Initializing and Saving Data Log.....	6-15
6-2-4	Initializing and Saving the Operation Log	6-16
6-2-5	Initializing and Saving the Error Log.....	6-18
6-2-6	Language Selection	6-19
6-2-7	Removing the Memory Card.....	6-20
6-2-8	Initializing Internal Holding Memories (\$HB/\$HW).....	6-21
6-3	PT Settings.....	6-22
6-3-1	Start-up Wait Time.....	6-26
6-3-2	Screen Saver.....	6-27
6-3-3	Key Press Sound.....	6-28
6-3-4	Buzzer Sound	6-28
6-3-5	Backlight Brightness	6-29
6-3-6	Calendar Check	6-32
6-3-7	Printer Type.....	6-33
6-3-8	Printing Mode.....	6-33
6-3-9	Orientation.....	6-34
6-3-10	Changing Values in Device Monitor Setting.....	6-34
6-3-11	Contrast (NS5-SQ□□/NS5-MQ□□ Only)	6-34
6-3-12	CJK Han Unification Priority.....	6-35
6-3-13	Alarm Monitor Registration Procedure	6-35

6-1 Operating Modes and System Menu

6-3-14 Starting the Ladder Monitor from Alarm/Event Summary and History (NS15/12/10/8 Only).....	6-36
6-3-15 Setting the Tag Update Notification Message.....	6-36
6-3-16 Time to Switch to System Menu (NS12, NS10, NS8, or NS5).....	6-36
6-3-17 Double-touch Interval (NS15 Only).....	6-37
6-3-18 Analog RGB Output (NS15 only).....	6-37
6-4 Project Settings.....	6-38
6-4-1 Project Title.....	6-38
6-4-2 Number of Labels.....	6-39
6-4-3 Initial Screen.....	6-39
6-4-4 Initial Label.....	6-39
6-4-5 Barcode Input When Using Keypad.....	6-39
6-4-6 Alarm/Event History Recording Method.....	6-39
6-4-7 Data Log Recording Method.....	6-40
6-4-8 Operation Log Recording Method.....	6-40
6-4-9 Error Log Recording Method.....	6-40
6-4-10 System Memory.....	6-40
6-5 Setting Passwords.....	6-41
6-5-1 Changing the Password.....	6-41
6-5-2 Setting the Password Function.....	6-42
6-6 Communications Settings.....	6-44
6-6-1 Communications Conditions.....	6-44
6-6-2 Setting 1:1 NT Link.....	6-46
6-6-3 Setting High-speed 1:N NT Links (Standard, High-speed).....	6-47
6-6-4 Ethernet and EtherNet/IP Settings.....	6-47
6-6-5 Setting the Controller Link Network.....	6-50
6-6-6 Setting Bar Code Readers.....	6-51
6-6-7 Modem Settings.....	6-52
6-7 Screen Data Check.....	6-53
6-8 Special Screens.....	6-54
6-8-1 Alarm History.....	6-55
6-8-2 Operation Log.....	6-56
6-8-3 Error Log.....	6-57
6-8-4 Device Monitor.....	6-58
6-8-5 Communication Test.....	6-60
6-8-6 Video Configuration.....	6-62
6-8-7 USB Device List.....	6-64
6-8-8 Display Capture Data.....	6-65
6-8-9 Memory Card Transfers.....	6-66
6-8-10 External Application Startup.....	6-68
6-8-11 Version Display.....	6-69
6-8-12 PLC Data Trace (NS15, NS12, NS10, and NS8 Only).....	6-69
6-8-13 NJ-series Troubleshooter.....	6-71
6-9 Hardware Check.....	6-72
6-9-1 LCD Check.....	6-72
6-9-2 Touch Switch Check.....	6-73
6-9-3 Touch Panel Calibration (NS15 Only).....	6-73
6-10 Starting Operations.....	6-74

6-11 Verifying Tags..... 6-76

6-1 Operating Modes and System Menu

The System Menu can be used to set various PT settings by operating the touch switches on the screen. The following diagram shows the menu configuration in the System Menu. Refer to 6-1-4 *Using the System Menu* for details on System Menu operations.

6-1-1 Mode Configuration

The NS-series PTs have the following operating modes.

Mode	System Menu:	Displays the System Menu, and sets each of the settings for the PT.	
	RUN mode:	Displays screens, allows data input, and communicates with each device.	
	TRANSFER mode:	Data transfer with CX-Designer:	Uploads and downloads screen data and system programs between the CX-Designer (computer) and PT.
		Memory Card transfer:	Uploads and downloads screen data and system programs via the Memory Card.
	ERROR mode:	Fatal error:	Stops processing (operating) and displays error message.
Non-fatal error:		Continues processing (operating) without displaying error message.	

6-1-2 System Menu Configuration

The System Menu items and functions are as follows:

System Menu	Initialize:	Initializes or saves operation log, alarm/event histories, data log, error log, and formats screen data, initializes internal holding memories, provides a function to remove the Memory Card, and sets the system language.
	Save:	
	PT:	Sets the system startup waiting time, screen saver, key press sound, buzzer, backlight, and calendar check. Also makes the settings for the printer connected to the PT and the alarm monitor registration method.
	Project:	Displays the project title, number of labels, history recording method, and addresses allocated to the system memory. Displays and sets the screen numbers displayed at startup time.
	Password:	Sets the password functions (including passwords with levels). Also sets and changes passwords.
	Comm:	Sets the communications conditions for serial ports A and B, a modem (data transfer), Host Link, Ethernet, and Controller Link.
	Data Check:	Checks the stored screen contents without communications.
	Special Screen:	Displays the operation log, alarm history, error log, device monitor, communication test, version display, capture data, and PLC data trace, and performs video configuration. Also lists devices connected to the USB port.
	Hardware Check:	Performs a hardware check, such as checking that the touch panel is operating properly.

6-1-3 Overview of Menu Items

The following tables show the eight menu items and provide an overview of their contents.

1. Initialize Tab

Item	Function	Page
Screen Data Area	Formats project data, such as screen data.	P. 6-12
Alarm/Event History	Initializes or saves in a CSV file in the Memory Card the alarm/event history data that has been generated during operation.	P. 6-13
Data Log	Initializes or saves in a CSV file in the Memory Card the data log data that registers changes to the contents of an address, or saves in the Memory Card as a CSV file.	P. 6-15
Operation Log	Initializes or saves in a CSV file in the Memory Card the operation log data, such as that for functional object operations and screen switching.	P. 6-16
Error Log	Initializes or saves in a CSV file in the Memory Card the error log data that is generated by macro errors.	P. 6-18
Select language	The language to display system menus, input keypads, error messages, etc., can be set to Japanese, English, Italian, Spanish, French, German, or Chinese (traditional or simplified).	P. 6-19
Memory Card	The Memory Card in the PT can be removed.	P. 6-20
Internal Holding Memory (\$HB/\$HW)	Initializes the Internal Holding Bit/Word Memories.	P. 6-21

2. PT Settings Tab

Item	Function	Page
Start-up Waiting Time	Sets the system startup waiting time. Communications are not performed during this specified time when the power is turned ON or the PT is reset. The default is 0 s.	P. 6-26
Screen Saver	Sets the screen saver to ON or OFF. The default setting is OFF.	P. 6-27
Screen Saver Start-up Time	Sets the amount of time after which the screen saver is started. The default setting is 15 min. If the screen saver start-up time is indirectly specified, the address of the allocation destination will be displayed.	P. 6-27
Key Press Sound	Sets whether a sound will be heard when a touch switch is pressed. The default setting is ON.	P. 6-28
Buzzer Sound	Sets whether a buzzer will be heard when a command from the host is received or an error occurs. The default setting is ERR ON.	P. 6-28
Backlight	Sets the backlight brightness to one of three levels. The brightness cannot be adjusted much. The default setting is High.	P. 6-29
Backlight Brightness (NS5-SQ1, NS5-TQ1, NS8, NS10, NS12, and NS15)	The brightness of the backlight can be adjusted to one of three or one of 32 levels. The default is the highest level for 3-level adjustment. With the 32-level adjustment, the brightness can be adjusted to a lower level than the low level of 3-level adjustment.	P. 6-29
External brightness adjustment (NS15 only) (This applies to lot numbers 30114 and earlier.)	Enables the brightness of NS-series PT panel backlighting to be adjusted externally. It allows panel brightness to be set lower than the Low selection in the backlight brightness settings.	P. 6-29
Calendar Check	Displays and sets the date and time for the internal clock.	P. 6-31
Printer Type	Sets the control method for the printer connected to the PT.	P. 6-32
Mode	Sets the printing method for the printer connected to the PT.	P. 6-32
Orientation	Sets the paper orientation for the printer connected to the PT.	P. 6-33
Changing Value in Device Monitor Setting	Selects whether to set or just monitor device monitor values in the functions for Registered Monitor and 6-3-9 Switch Box.	P. 6-33
Contrast (NS5-SQ/MQ only)	Adjusts the contrast for the screen. (This applies to lot number 2110 or earlier for the NS5-SQ.)	P. 6-33

6-1 Operating Modes and System Menu

CJK Han Unification Priority	The CJK Han unification setting is used to select what character style (traditional Chinese, simplified Chinese, or Japanese) will be given priority for display.	P. 6-34
Alarm Monitor Registration Method	Specifies the method for performing monitor registration of alarms and events.	P. 6-34
Starting Ladder Monitor from Alarm/Event Summary and History (NS15/NS12/10/8 only)	Specifies whether to start the ladder monitor when an alarm/event summary or history record is pressed.	P. 6-35
Tag Update Notification Message Setting	Specifies whether to display a confirmation message before starting tag verification when tags are verified while the NS-series PT is operating.	P. 6-35
Time to Switch to System Menu (NS12, NS10, NS8, or NS5)	Sets the time required to switch to the System Menu when two of the four screen corners are pressed. The time to switch to the System Menu can be set to between 0 and 5 s.	P. 6-35
Double-touch interval (NS15 only)	With the NS15, one corner of the screen must be touched twice in a row to move to the System Menu. The interval between the touches can be set.	P. 6-36
Analog RGB Output (NS15 only)	Sets whether to use the analog RGB output. The default setting is <i>Disable</i> .	P. 6-36

3. Project Tab

Item	Function	Page
Project Title	Displays the project title.	P. 6-37
Number of Labels	Displays the number of corresponding labels.	P. 6-38
Initial Screen	Sets and displays the screen numbers first displayed after the power is turned ON.	P. 6-38
Initial Label	Sets and displays the label number shown on the screen after the power is turned ON.	P. 6-38
Barcode input when using keypad	Disables data input from barcodes when the keypad is being used.	P. 6-38
Alarm/Event Recording Method	Displays the method for recording the alarm/event histories.	P. 6-38
Data Log Recording Method	Displays the method for recording the data log.	P. 6-39
Operation Log Recording Method	Displays the method for recording the operation log.	P. 6-39
Error Log Recording Method	Displays the method for recording the error log.	P. 6-39
System Memory (\$SB)	Displays the allocated addresses of the system bit memory (\$SB).	P. 6-39
System Memory (\$SW)	Displays the allocated address of the system word memory (\$SW).	P. 6-39

4. Password Tab

Item	Function	Page
Level 1	Changes the level 1 password.	P. 6-40
Level 2	Changes the level 2 password.	P. 6-40
Level 3	Changes the level 3 password.	P. 6-40
Level 4	Changes the level 4 password.	P. 6-40
Level 5	Changes the level 5 password.	P. 6-40
Password mode	Selects the password function (including passwords with levels).	P. 6-41
Time Out	Specifies whether user authentication is automatically canceled after a set time has elapsed.	P. 6-41
Timeout (min)	Sets the timeout time.	P. 6-41
Switch Screen when canceling the authentication	Specifies whether the screen is switched automatically when authentication is canceled.	P. 6-41
Switch Screen No.	Sets the screen number that is displayed at when authentication is canceled.	P. 6-41

5. Comm Tab

Item	Function	Page
Comms. Auto-return	Selects whether automatic recovery is used when a communications error occurs.	P. 6-43
Timeout interval	Sets and displays the timeout monitor time.	P. 6-43
Retry Counts	Sets and displays the number of communications retries.	P. 6-43
Serial Port A	Sets and displays whether serial port A is used, the communications method, and other details.	P. 6-43
Serial Port B	Sets and displays whether serial port B is used, the communications method, and other details.	P. 6-43
Expansion Interface	Sets and displays the connector used by serial port B (NS5 only).	P. 6-43
Ethernet	Sets and displays whether Ethernet is used and communications details.	P. 6-46
Controller Link	Sets and displays whether Controller Link is used and communications details.	P. 6-47

6. Data Check Tab

Item	Function	Page
Screen Number	Sets the screen number that is displayed as a sample.	P. 6-52
Show Address	Displays the communications addresses set for the sample display.	P. 6-52

7. Special Screen Tab

Item	Function	Page
Alarm History	Displays the alarm history screen.	P. 6-54
Operation Log	Displays the screen for recording the operation log.	P. 6-55
Error Log	Displays the screen for recording the error log.	P. 6-56
Special Functions	Displays the device monitor screen and communications test screen. This function also starts external applications, lists USB devices, performs Video Configuration, displays capture data or PLC data trace data.	P. 6-57 to P. 6-63
System Version	Displays the version display screen.	P. 6-64

8. Hardware Check Tab

Item	Function	Page
LCD Check	Checks the LCD.	P. 6-71
Touch Switch Check	Checks the touch switches.	P. 6-72
Touch panel Calibration (NS15 Only)	Calibrates the touch positions.	P. 6-72

6-1-4 Using the System Menu

Information on using the menus, such as displaying the System Menu, and selecting menu items, is provided here.

Reference The system settings set in the project data are given priority over those set in the System Menu.

● Displaying the System Menu

The System Menu can be displayed by using any of the following methods.

1. Press two of the four corners of the touch panel simultaneously (NS12/10/8/5 only).
2. Press one of the four corners of the touch panel twice in a row (NS15 only).
3. Press the command button in the System Menu display.
4. Press a command button set to switch the screen to the system menu.
5. Specify screen number 4002 BCD (FA2 binary) and switch the screen.
6. Press or change the value of a Multifunction Object set to display the System Menu.

1. Pressing the Corners of the Touch Panel (NS12/10/8/5)

The System Menu can be displayed by pressing two of the four corners of the PT touch panel simultaneously, as shown in the following diagram.

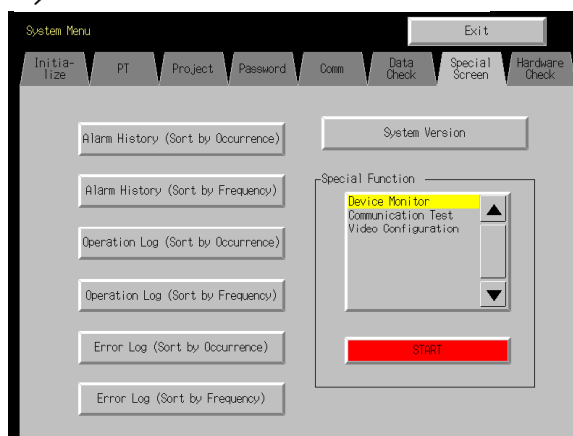
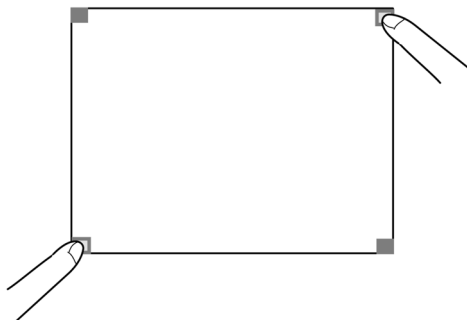

When pressing the corners of the touch panel, however, first press a corner that does not have a functional object displayed. If the position of a functional object is pressed, its function will be performed. If the command button for switching screens is kept pressed after the screen has been switched, it will be detected as if the button has been released.

The second corner pressed can be any of the other three corners. The System Menu will be

displayed even if functional objects are displayed.

Reference The time required to switch to the System Menu can be set in the Time to keep pressing 2 corners on the screen [sec] for Entering System Menu Field on the PT Settings Tab Page in the System Menu.

2. Press one of the four corners of the touch panel twice in a row (NS15 only).

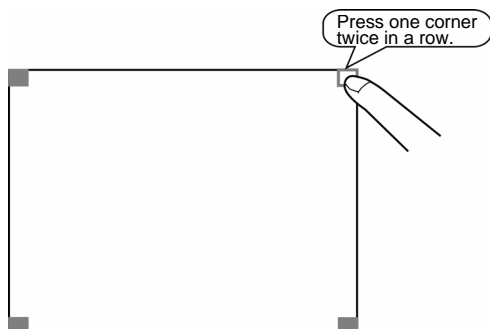

Make sure you press a corner where no functional object is displayed. If there is a functional object at the corner you press, the function of the functional object will be executed.

Reference The touch interval (i.e., speed) for pressing one of the four corners of the touch panel twice in a row can be adjusted using the double-touch interval setting on the PT Tab Page in the System Menu.

3. Pressing the Command Button in the System Menu

While creating screens, if a command button for displaying the System Menu is created in the screen, the System Menu can be displayed by pressing this command button.

4. Pressing Command Buttons to Switch Screens

The *Display System Menu* function of command buttons includes an option to display the **Initialize** Tab (the first screen of the System Menu). Press a command button for which this option has been set.

Alternatively, the *Screen Switch* command button functions include a *Indirect Specification of Screen No.* function. Store the BCD value 4002 (binary FA2) in the communications address for indirect specification and press the command button.

Refer to 2-9 *Buttons* in the *Programming Manual* for information on command buttons.

5. Storing 4002 in \$SW0 (in System Memory)

A BCD value of 4002 (binary FA2) can be stored in \$SW0 (in System Memory). Refer to 2-4 *System Memory* in the *NS Series Programming Manual* for information on the system memory.

6. Press a Multifunction Object to Display the System Menu

Press the **Switch Screen** Button of Multifunction Object and set it to *Display System Menu - System Menu Top Page [Initialize Tab]*. Then touch or change the value of this Multifunction Object to display the System Menu.

6-1 Operating Modes and System Menu

● Selecting Menu Items

Items in the System Menu can be displayed by simply pressing the tab of the menu item to be displayed.

Example: Press the **Hardware Check** Tab in the System Menu to display the Hardware Check Screen.

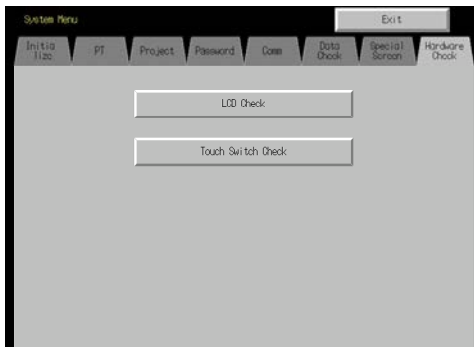
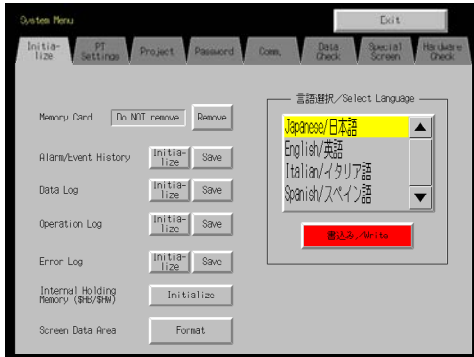

● Switching to RUN Status from the System Menu

Press the **Exit** Button to return to RUN mode.

6-2 Initializing and Saving Data and Removing the Memory Card

The Initialize Tab is used to initialize or save the PT data and specify the system language. Use these function whenever necessary.

- Memory Card (remove)
- Alarm/event history (initialize, save)
- Data log (initialize, save)
- Operation log initialization (initialize, save)
- Error log (initialize, save)
- Internal Holding Memories (\$HB/\$HW) (initialize)
- Screen data area (format)

NS15 Data Initialize Screen

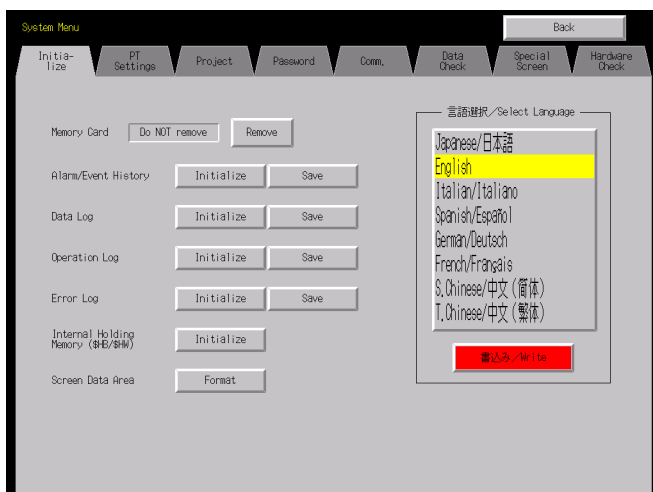

NS12 Data Initialize Screen

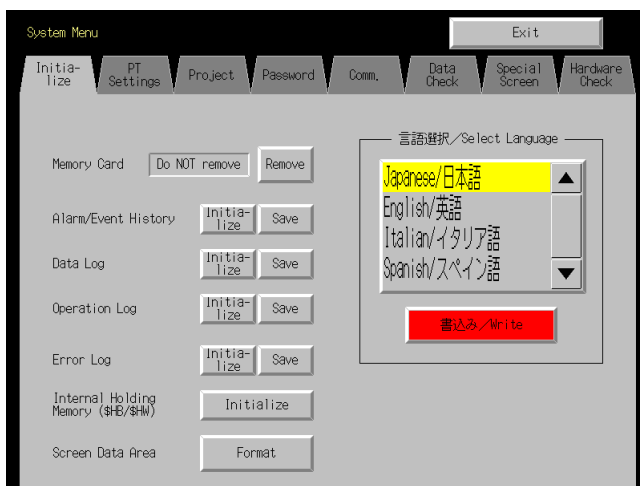

6-2 Initializing and Saving Data and Removing the Memory Card

NS10/NS8 Data Initialize Screen



NS5 Data Initialize Screen

Page 1

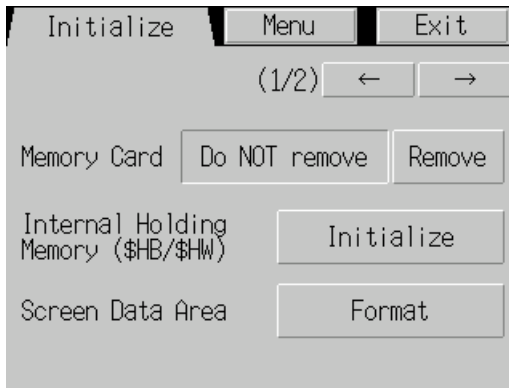

Page 2

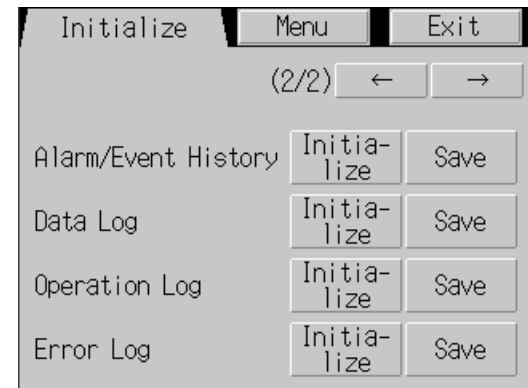

6-2-1 Screen Data Area Format

This function formats the PT screen data. Screen data must be formatted if it is corrupted and cannot start up properly. The data recorded for the operation log, alarm history, data log, and error log is not initialized when screen data is formatted.

Precautions for Safe Use

Before formatting screen data, check that the screen data has been backed up from the CX-Designer.

Format the screen data by using operations from the Initialize Data Tab Page in the System Menu, as follows:

1. Press the **Screen Data Area** Button.
A confirmation message will be displayed. Press the **Yes** Button to format the data. Press the **No** Button to cancel the initialize function.

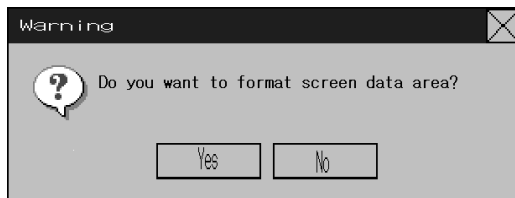

2. When the PT has completed formatting screen data, a dialog box will be displayed indicating that the screen data has finished being formatted.



3. An error message will be displayed if the System Menu is closed while screen data is being formatted. Always transfer the screen data from the CX-Designer or Memory Card after formatting.

Reference • The PT must be restarted after screen data has been transferred.

6-2-2 Initializing or Saving the Alarm/Event History

This function initializes or saves the alarm/event histories saved in the PT.

Use this function when screen data has been changed, for initializing history data, or for saving history data in the Memory Card as a CSV file.

While the PT is running, the alarm/event histories continually check the status of bits registered as alarms/events and record the date, time, and number of times the bits turned ON/OFF.

Up to 1,024 alarms/events can be recorded.

Reference

- The alarm/event histories can also be initialized by turning ON \$SB32 in system memory from the host.
- The alarm/event histories will be deleted when project data or system programs are downloaded.
- The alarm/event histories can also be saved by turning ON \$SB33 in system memory from the host. Refer to 2-4 System Memory in the *NS Series Programming Manual* for details.

6-2 Initializing and Saving Data and Removing the Memory Card

Initialize or save alarm/event histories by using operations from the Initialize Tab Page in the System Menu, as follows:

Initializing Alarm/Event Histories

1. Press the **Initialize** Button.
A confirmation message will be displayed. Press the **Yes** Button to initialize the data. Press the **No** Button to cancel the initialize function.

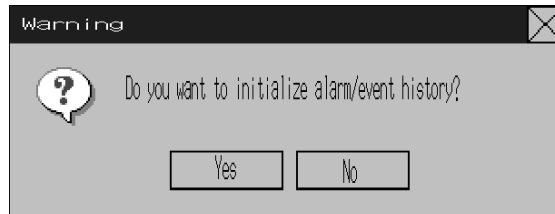

2. When the PT has completed initializing the alarm/event histories, a dialog box will be displayed indicating that the alarm/event histories have finished being initialized.

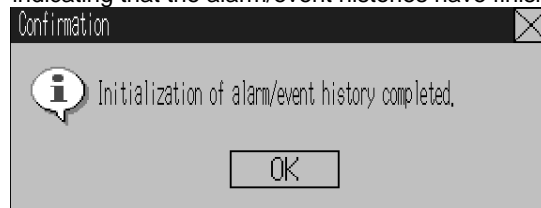

Saving Alarm/Event Histories

1. Press the **Save** Button. The Save Button will be lit yellow while data is being saved.
2. When the PT has completed saving the alarm/event histories, the Save Button will return to its normal color.
A dialog box will be displayed indicating that the save has been finished.

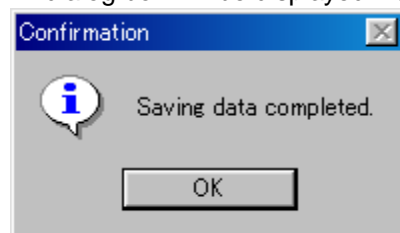

6-2-3 Initializing and Saving Data Log

This function initializes or saves the data log saved in the PT.

Use this function when screen data has been changed, or for initializing history data. The data log is used to record changes over time to the contents of an address that is registered in the log. Up to 50,000 events can be recorded.

-
- Reference**
- The data log for the specified group can be initialized by setting the group number in \$SW37 and turning ON \$SB35 in the system memory from the host. The data logs for all groups can be initialized by setting \$SW37 to 0.
 - The data log will be deleted when project data or system programs are downloaded.
 - The data log for the specified group can be saved by setting the group number in \$SW37 and turning ON \$SB36 in the system memory from the host. The data logs for all groups can be saved by setting \$SW37 to 0.
-

Initialize or save the data log by using operations from the Initialize Tab Page in the System Menu, as follows:

Initializing the Data Log

1. Press the **Initialize** Button.
A confirmation message will be displayed. Press the **Yes** Button to initialize the data. Press the **No** Button to cancel the initialize function.

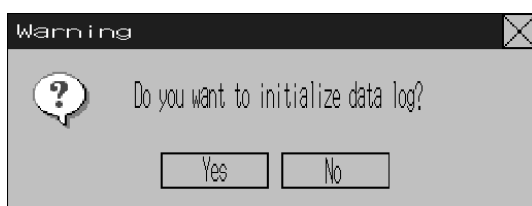

2. When the PT has completed initializing the data log, a dialog box will be displayed indicating that the data log has finished being initialized.

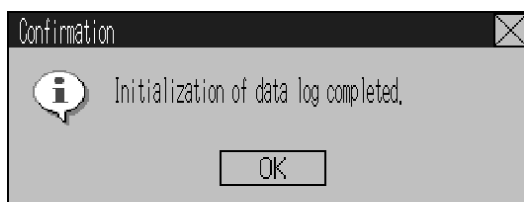

Saving the Data Log

1. Press the **Save** Button. The Save Button will be lit yellow while data is being saved.
2. When the PT has completed saving the data log, the Save Button will return to its normal color. A dialog box will be displayed indicating that the save has been finished.

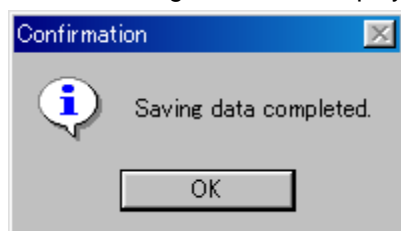

6-2-4 Initializing and Saving the Operation Log

This function initializes or saves the operation log saved in the PT.

Up to 1,024 operations can be recorded in order of occurrence.

Use this function when screen data has been changed, for initializing log data, or for saving log data as a CSV file in the Memory Card.

The operation log is used to record the number of times the following operations are performed and the order in which they occur.

- Functional object operation history
- Screen display history
- Macro execution history
- Communications address (bit) value change history

Refer to 2-4 System Memory in the *PT Programming Manual* for details.

-
- Reference**
- The functional objects that can be recorded are ON/OFF buttons, word buttons, Numeral Display & Input, String Display & Input, thumbwheel switches, data block tables, and Multifunction Objects.
 - The following methods can also be used to initialize operation log data with an NS-series PT.
 - Turn ON \$SB37 in system memory from the host.
 - Execute a Multifunction Object set to initialize the operation log.
 - For details on how to execute Multifunction Objects that have the operation log data initialization function set, refer to the *NS-series PT Programming Manual*.
 - The operation log will be deleted when project data or system programs are downloaded.
 - The following methods can be used to save operation log data with an NS-series PT.
 - Press the **Operation Log (Sort by Occurrence)** Button or **Operation Log (Sort by Frequency)** Button in the System Menu.
 - Turn ON \$SB38 in system memory from the host.
 - For details on how to execute Multifunction Objects that have the operation log data initialization function set, refer to the *NS-series PT Programming Manual*.
-

Initialize or save the operation log by using operations from the Initialize Tab Page in the System Menu, as follows:

Initializing the Operation Log

1. Press the **Initialize** Button.
A confirmation message will be displayed. Press the **Yes** Button to initialize the data. Press the **No** Button to cancel the initialize function.

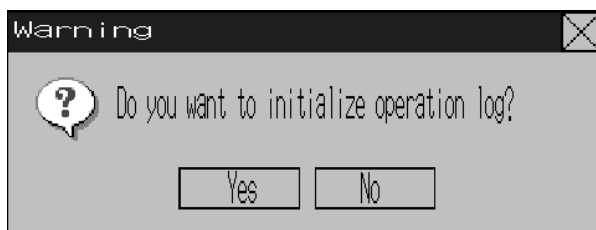

2. When the PT has completed initializing the operation log, a dialog box will be displayed indicating that the operation log has finished being initialized.

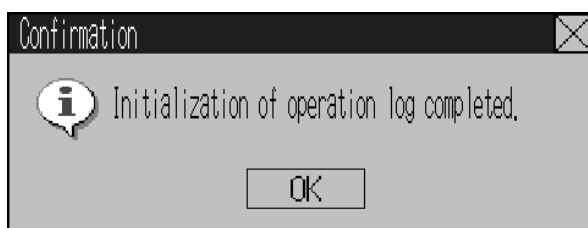

Saving the Operation Log

1. Press the **Save** Button. The Save Button will be lit yellow while data is being saved.
2. When the PT has completed saving the operation log, the Save Button will return to its normal color.
A dialog box will be displayed indicating that the save has been finished.

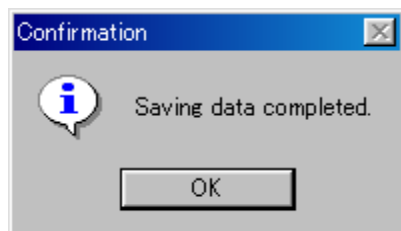

Reference • When saving the operation log, the operation log must be controlled from the system memory. For details on controlling the operation log, refer to *2-4 System Memory* in the *PT Programming Manual*.

6-2-5 Initializing and Saving the Error Log

This function initializes the macro error history saved in the PT or saves the history in the Memory Card.

Up to 100 errors can be recorded in the error log. The number of errors that can be recorded, however, also depends on the free space in the memory.

The error log records the errors that occur when the macro function is executed. Initialize or save the error history by using operations from the Initialize Tab Page in the System Menu, as follows:

Initializing the Error Log

1. Press the **Initialize** Button.
A confirmation message will be displayed. Press the **Yes** Button to initialize the data. Press the **No** Button to cancel the initialize function.

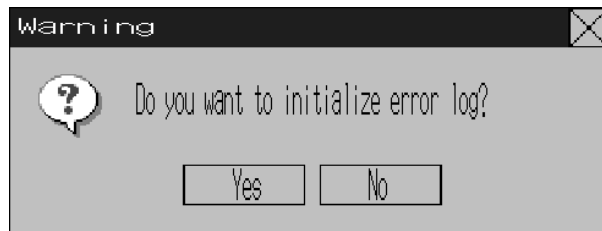

2. When the PT has completed initializing the error log, a dialog box will be displayed indicating that the error log has finished being initialized.



Saving the Error Log

1. Press the **Save** Button. The Save Button will be lit yellow while data is being saved.
2. When the PT has completed saving the error log, the Save Button will return to its normal color.
A dialog box will be displayed indicating that the save has been finished.

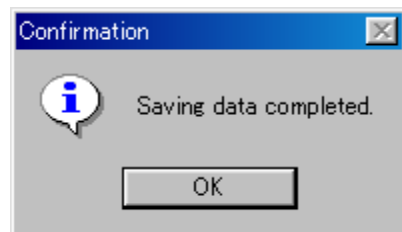

Reference

- The error log is deleted when project data or system programs are downloaded.
- The error log can also be initialized by turning ON \$SB42 in system memory from the host, and can be saved by turning ON \$SB43 in system memory from the host. Refer to 2-4 System Memory in the *PT Programming Manual* for details.

6-2-6 Language Selection

The system language can be set to Japanese, English, Italian, Spanish, French, German, or Chinese (traditional or simplified). The system language will be used on the System Menu, input keypads, message dialog boxes, etc, on the PT.

The system language is set from the **Initialize** Tab Page in the System Menu Window using the following procedure.

1. Select the system language in the *Select Language* Area.

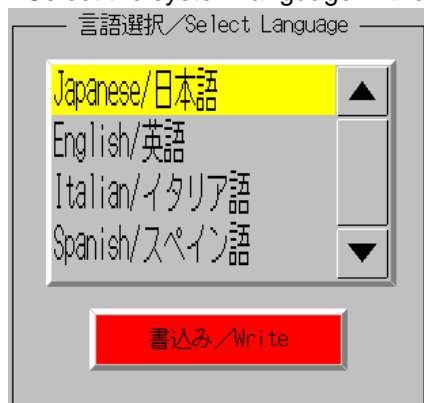

2. After specifying the language, click the **Write** Button. The system language will be switched after the new setting has been saved.

Reference If ASCII codes are set as the character display format for String Display & INPUT, list display, or data block tables (character fields), the following character codes will be used depending on the system language that is set.

System Language	Character display	Display example (character code B5)
Japanese	Shift-JIS code	†
Chinese (traditional and simplified)	GB2312 code	The corresponding character does not exist, so nothing is displayed.
English and other languages	Latin 1 code	μ

The above codes will also be used when indirect specifications are made for label strings for label objects.

6-2-7 Removing the Memory Card

The Memory Card can be removed from the PT while the PT is ON. Use the following procedure from the Initialize Tab Page of the System Menu to remove the Memory Card.

1. Press the **Remove** Button next to *Memory Card*.

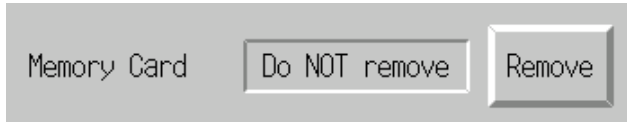

2. The following dialog box will be displayed when it is safe to remove the Memory Card. Press the **OK** Button.

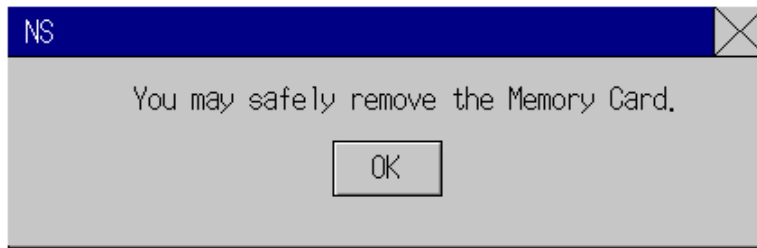

3. Confirm that it is safe to remove the Memory Card, and remove it from the PT.

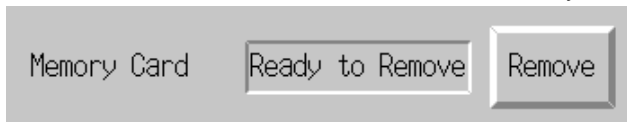

Precautions for Safe Use

When the Memory Card is removed, reinsert the Memory Card into the PT to use it again. Once a Memory Card is removed, it must be reinserted before the PT can access it.

Reference The Memory Card in the PT can be removed if the system memory bit \$SB50 turns ON (indicating that the Memory Card is ready to be removed) when the Host turns ON system memory bit \$SB49. Refer to 2-4 *System Memory* in the *NS Series Programming Manual* for details.

6-2-8 Initializing Internal Holding Memories (\$HB/\$HW)

The following procedure is used to initialize the Internal Holding Memories in the PT (\$HB0 to \$HB8191 and \$HW0 to \$HW8191). Use the following procedure from the Initialize Tab Page of the System Menu to initialize the Internal Holding Memories.

1. Press the **Initialize** Button for the Internal Holding Memories (\$HB/\$HW). The following confirmation message will be displayed. Press the **Yes** Button to initialize.

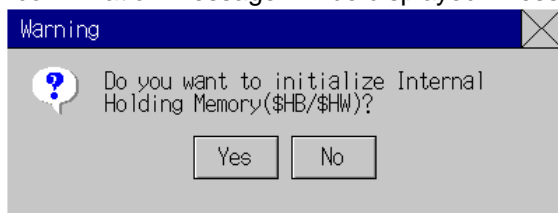

2. When Internal Holding Memory (\$HB/\$HW) initialization has been completed, the following notification message will be displayed. Press the **OK** Button.

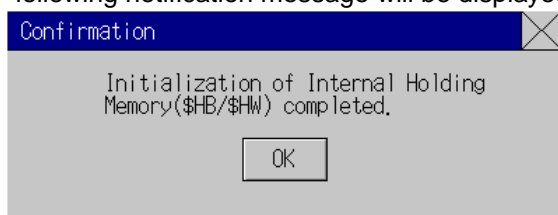

Reference The NS-series PT's internal holding memory (\$HB/\$HW) can be initialized by turning ON the system memory bit \$SB34 from the host. Refer to 2-4 *System Memory* in the *NS Series Programming Manual* for details.

6-3 PT Settings

The PT Tab Page is used to set the following functions.

- 6-3-1 Start-Up Wait Time
- 6-3-2 Screen Saver
- 6-3-3 Key Press Sound
- 6-3-4 Buzzer Sound
- 6-3-5 Backlight Brightness
- 6-3-6 Calendar Check
- 6-3-7 Printer Type
- 6-3-8 Printing Mode
- 6-3-9 Orientation
- 6-3-10 Changing Values in Device Monitor Setting
- 6-3-11 Contrast (NS5-SQ□□/NS5-MQ□□ Only)
- 6-3-12 CJK Han Unification Priority
- 6-3-13 Alarm Monitor Registration Procedure
- 6-3-14 Starting the Ladder Monitor from Alarm/Event Summary and History (NS15/12/10/8 Only)
- 6-3-15 Setting the Tag Update Notification Message
- 6-3-16 Time to Switch to System Menu (NS12, NS10, NS8, or NS5)
- 6-3-17 Double-touch Interval (NS15 Only)
- 6-3-18 Analog RGB Output (NS15 only)

PT Tab Page for the NS12

(Page 1) Backlight Brightness Adjustment to Three Levels

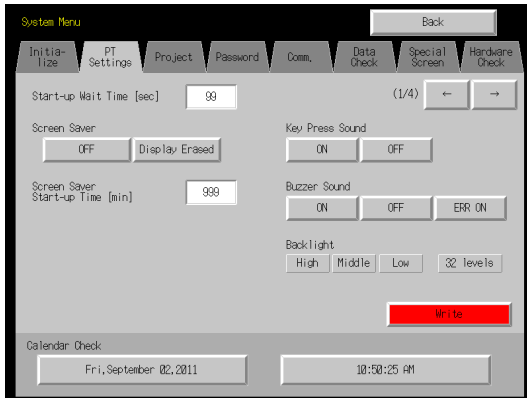

(Page 1) Backlight Brightness Adjustment to 32 Levels

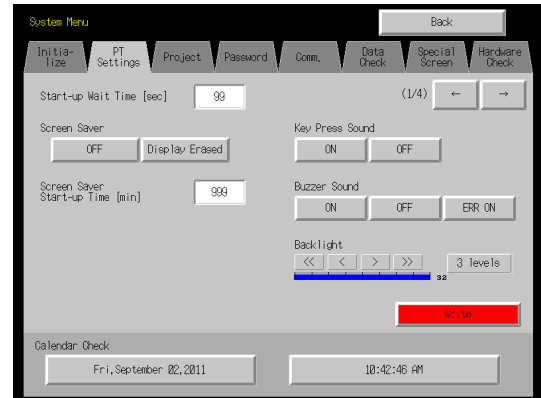

(Page 2)

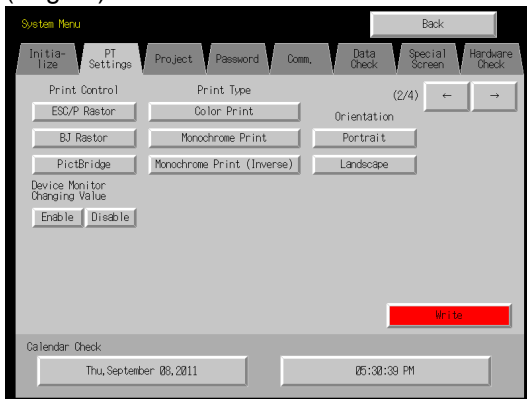

(Page 3)

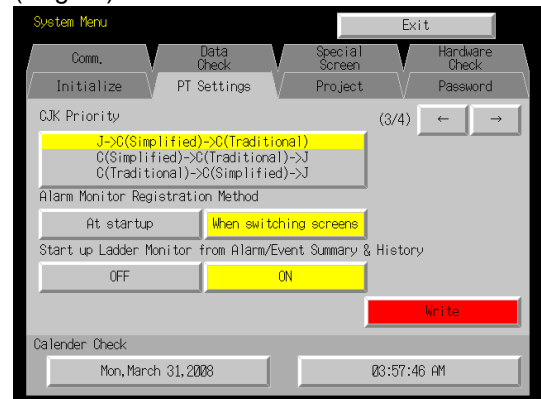

(Page 4)

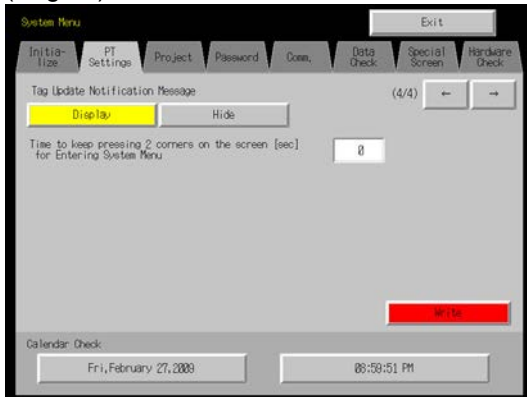

6-3 PT Settings

PT Tab Page for the NS10 and NS8

(Page 1) Backlight Brightness Adjustment to Three Levels

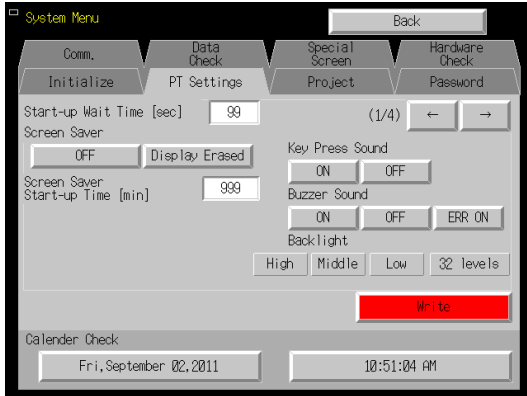

(Page 1) Backlight Brightness Adjustment to 32 Levels

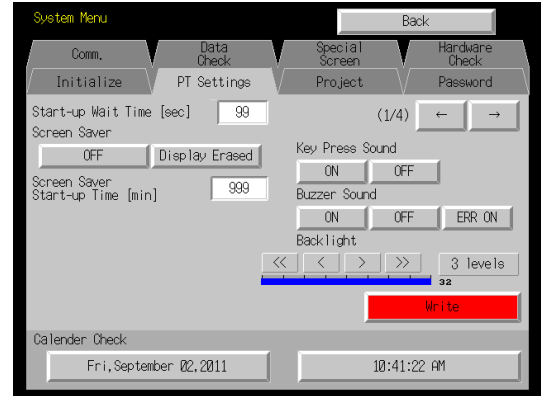

(Page 2)

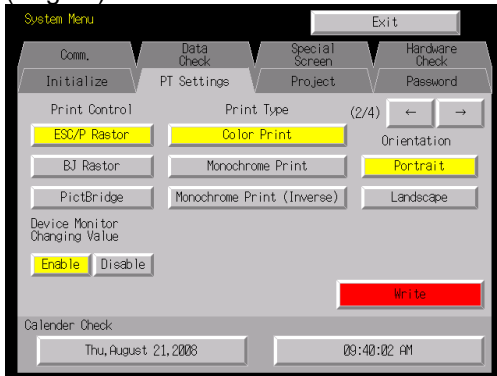

(Page 3)

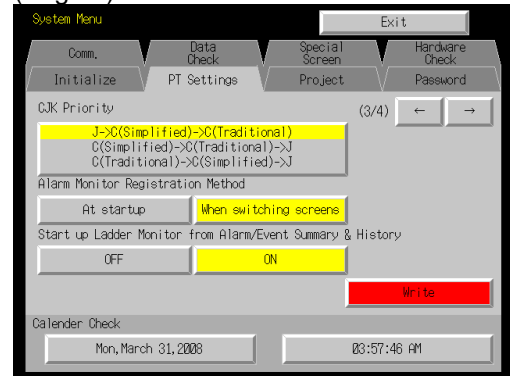

(Page 4)

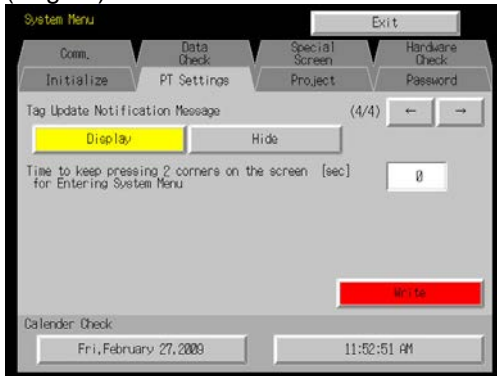

PT Tab Page for the NS5
(Page 1)

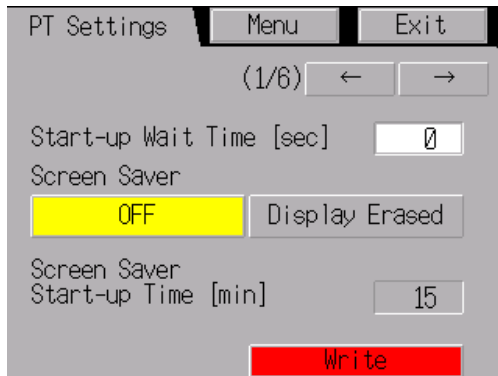

(Page 2) Backlight Brightness Adjustment to Three Levels

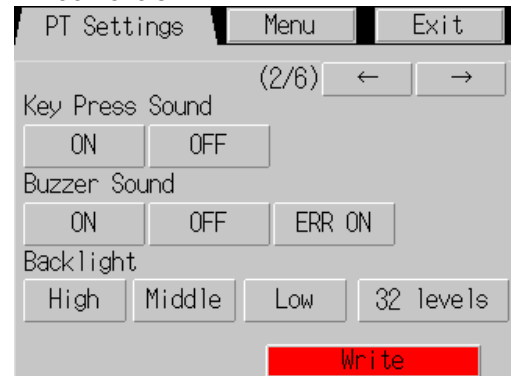

(Page 2 with Backlight Brightness Adjustment to 32 Levels)



(Page 3)

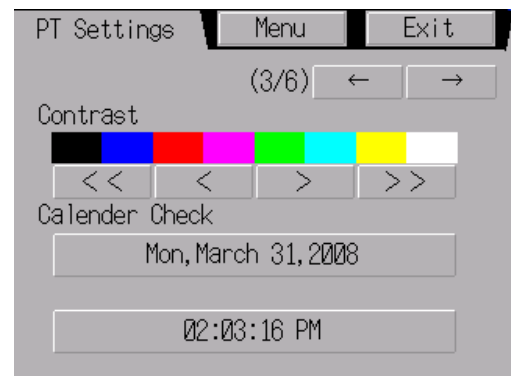

(Page 4)

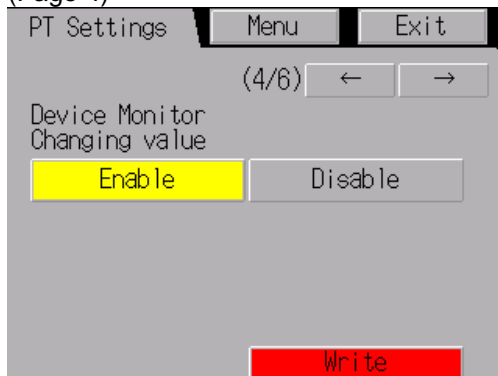

(Page 5)

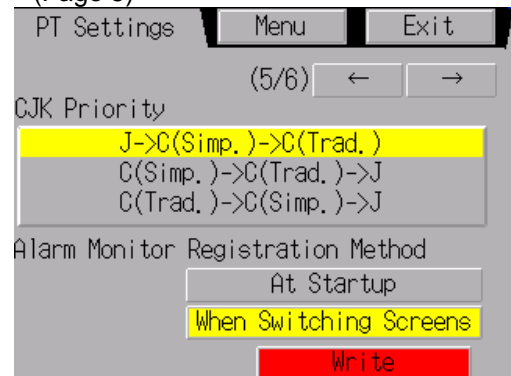

(Page 6)



6-3 PT Settings

PT Tab Page for the NS15
(Page 1) Backlight Brightness Adjustment to Three Levels

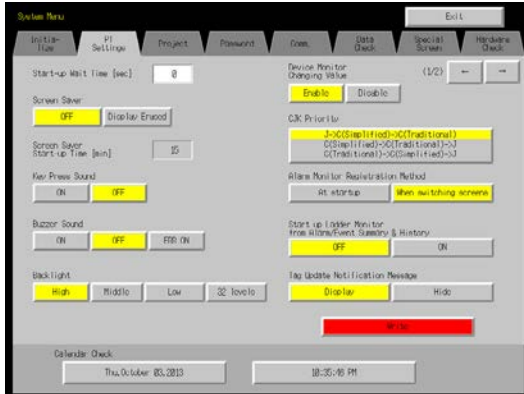

(Page 1) Backlight Brightness Adjustment to 32 Levels

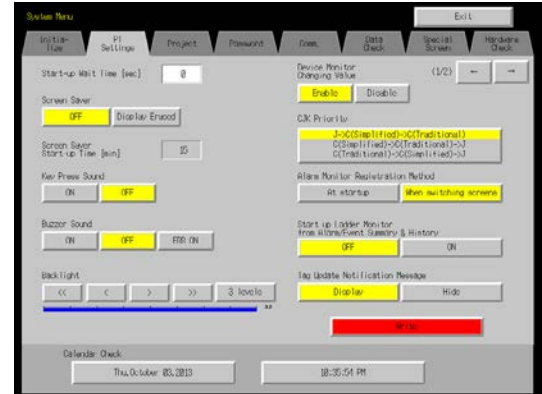

(Page 2)



6-3-1 Start-up Wait Time

The start-up wait time refers to the waiting time before the PT starts communicating with the host after the PT power is turned ON or the PT is reset. Set the system startup waiting time when the host requires time before it starts running.

The setting range is between 0 and 10 s and the default is 0 s.

Set the system startup waiting time by using operations from the PT Tab Page in the System Menu, as follows:

1. Set the waiting time in the *Start-up Wait Time* field in second units.
Input the value in the dialog box that is displayed by pressing the setting input column.

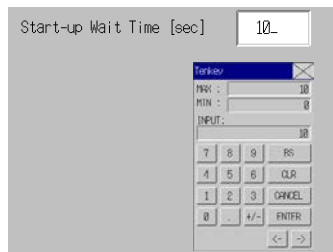

2. After setting, press the **Write** Button to save the setting.

-
- Reference** • Nothing is displayed during the system startup waiting time.
- The system startup waiting time is calculated from when initialization finishes. Therefore, if the startup waiting time is set to 0 s, the PT will not start actual communications with the host immediately after the power is turned ON.
-

6-3-2 Screen Saver

To extend the life of the backlight, the screen saver function turns OFF the screen display when operations are not performed for a fixed period of time.

The default setting is for no screen saver.

The time before the screen saver function is activated can be set in one-minute units between 1 and 255 minutes. The default setting is 15 min.

Set the screen saver movement by using operations from the PT Tab Page in the System Menu, as follows:

1. Select either **OFF** or **Display Erased** for the screen saver.
2. If **Display Erased** is selected, set the screen saver startup time.
Input the value in the dialog box that is displayed by pressing the setting input column.

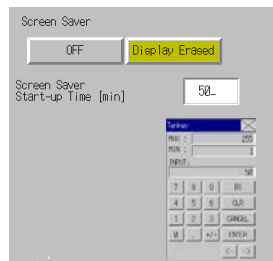

3. After setting, press the **Write** Button to save the setting.

If the screen saver start-up time is set to *Indirect Specification* with the CX-Designer, the address of the allocation destination will be displayed. The address of the allocation destination will be displayed only. It cannot be changed.

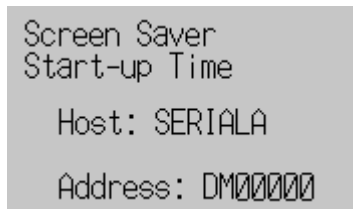

-
- Reference** Pressing any part of the touch panel will cancel the screen saver and display the previously displayed screen. When canceling the screen saver, If the part of the touch panel corresponds to the input for a functional object, the screen saver will be cancelled only. The input for the functional object will not be processed.
-

6-3-3 Key Press Sound

This function sets whether an input sound is heard when the touch switches that allow input functions for the PT are pressed.

ON: Input sound is heard when the touch switches that allow input functions for the PT are pressed.

OFF: Input sound is not heard when the touch switches that allow input functions for the PT are pressed.

The default setting is ON.

1. Select either **ON** or **OFF** for the touch switch input sound.

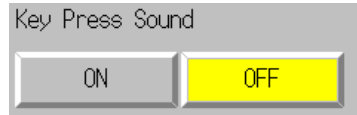

3. After setting, press the **Write** Button to save the setting.

6-3-4 Buzzer Sound

The buzzer is used at times such as when a command from the host is received or an error occurs. This function is set to ON or OFF in the System Menu.

ON: Buzzer turns ON when a command is received from the host or an error occurs.

OFF: Buzzer is OFF.

ERR ON: Buzzer turns ON when an error occurs only.

The default setting is ERR ON.

-
- Reference**
- Other commands and settings associated with the buzzer exist, but the settings here have the highest priority.
 - When the buzzer is set to ON or ERR ON, the buzzer will be heard when messages are displayed with a cross (X) or exclamation mark (!) icon.
 - Refer to 2-20 *Special Functions* in the *Programming Manual* for details on the buzzer function.
-

Set the buzzer to ON/OFF by using operations from the PT Tab Page in the System Menu, as follows:

1. Select either **ON**, **OFF**, or **ERR ON** for the buzzer setting.

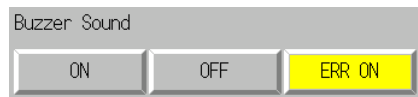

4. After setting, press the **Write** Button to save the setting.

6-3-5 Backlight Brightness

NS15

This function sets the backlight brightness.

The brightness of the backlight can be set to any of three levels or to an external adjustment. The default setting is for *High*.

Perform the following procedure from the PT Operation Tab Page of the System Menu to set the brightness of the backlight.

1. Select one of the three levels, *High*, *Middle*, or *Low*, or select *External* for the backlight brightness.



2. Press the **Write** Button. The setting will be saved.
3. If *External* is set, the following dialog box will be displayed to confirm writing the PT settings when the **Write** Button is pressed.

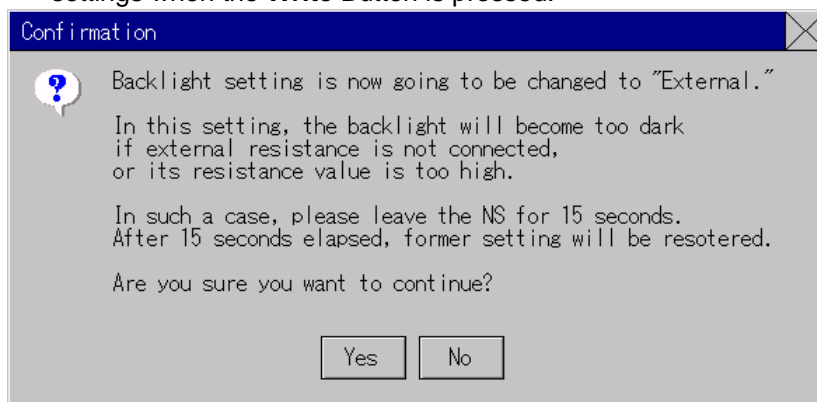

Press the **Yes** Button to write the PT settings.

Press the **No** Button to cancel writing the PT settings.

4. The following confirmation dialog box will be displayed if the **Yes** Button is pressed.

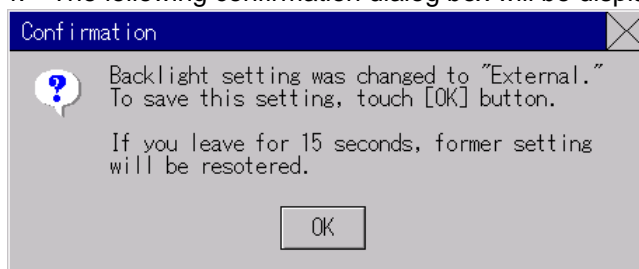

Press the **OK** Button to write the PT settings, including the backlight brightness.

If 15 s elapses without the **OK** Button being pressed or the Close Button is pressed, the backlight brightness and other PT settings will not be written.

If *External* is selected, the external brightness adjustment of the NS15 can be set. Refer to *3-10 External Brightness Adjustment* for information on the external brightness adjustment connector.

-
- Reference**
- The backlight brightness cannot be changed using \$SB6 to \$SB8 in system memory if External is set for the backlight brightness. To change the backlight brightness by using \$SB6 to \$SB8, turn OFF external brightness adjustment by selecting *High*, *Middle*, or *Low*.
 - Steps 3 and 4, above, are required only if *External* is set.
-

NS15 PTs with Lot Number 31114 or Later

This function sets the backlight brightness.

The brightness can be set to one of three levels or one of 32 levels.

The default is the highest level for 3-level adjustment.

The brightness of the RUN indicator will change according to the brightness setting of the backlight.

Set the brightness of the backlight by using operations from the PT Settings Tab Page in the System Menu, as follows:



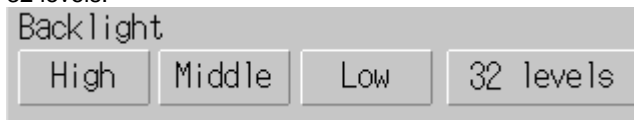

1. Select one of the three backlight brightness levels, high, middle, or low, or select setting to one of 32 levels.



2. After setting, press the **Write** Button to save the setting.
3. If setting to one of 32 levels is selected, the following setting screen will appear.



Brightness Setting Button Functions

- | | | | |
|---|---------------------------------------|--|---------------------------------------|
|  | Decreases the brightness by 5 levels. |  | Increases the brightness by 5 levels. |
|  | Decreases the brightness by 1 level. |  | Increases the brightness by 1 level. |

4. The backlight brightness will change when any of the brightness setting buttons is pressed. If the Write Button is not pressed and no other operation is performed for 30 seconds after setting the brightness, the brightness setting will return to the original setting, and the PT settings, including the backlight brightness setting, will not be written.
5. After setting, press the **Write** Button within 30 seconds to save the setting.

Precautions for Safe Use

If the brightness of the backlight is reduced, the display and RUN indicator may be very dark. Do not reduce the brightness of the backlight so far that the display and RUN indicator cannot be seen.

NS12, NS10, NS8, or NS5

This function sets the backlight brightness to one of three levels.

The default setting is high.

Set the brightness of the backlight by using operations from the PT Tab Page in the System Menu, as follows:

1. Select one of the three backlight brightness levels to set to high, middle, or low.

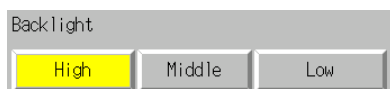

2. After setting, press the **Write** Button to save the setting.

NS5-SQ1/-TQ1 PTs with Lot Number 15Z0 or Later, NS8 PTs with Lot Number 28X1 or Later, NS10 PTs with Lot Number 11Y1 or Later, and NS12 PTs with Lot Number 14Z1 or Later

This function sets the backlight brightness.

The brightness can be set to one of three levels or one of 32 levels.

The default is the highest level for 3-level adjustment.

The brightness of the RUN indicator will change according to the brightness setting of the backlight.

Set the brightness of the backlight by using operations from the PT Settings Tab Page in the System Menu, as follows:



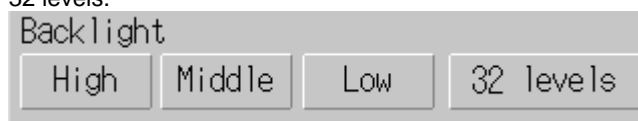

1. Select one of the three backlight brightness levels, high, middle, or low, or select setting to one of 32 levels.



2. After setting, press the **Write** Button to save the setting.
3. If setting to one of 32 levels is selected, the following setting screen will appear.



Brightness Setting Button Functions

	Decreases the brightness by 5 levels.		Increases the brightness by 5 levels.
	Decreases the brightness by 1 level.		Increases the brightness by 1 level.

4. The backlight brightness will change when any of the brightness setting buttons is pressed. If the Write Button is not pressed and no other operation is performed for 30 seconds after setting the brightness, the brightness setting will return to the original setting, and the PT settings, including the backlight brightness setting, will not be written.
5. After setting, press the **Write** Button within 30 seconds to save the setting.

Precautions for Safe Use

If the brightness of the backlight is reduced, the display and RUN indicator may be very dark. Do not reduce the brightness of the backlight so far that the display and RUN indicator cannot be seen.

6-3-6 Calendar Check

This function displays the time and date of the PT's internal system clock.

The factory settings for the date and time are not correct.

Set and display the date and time by using operations from the PT Tab Page in the System Menu, as follows:

1. The currently set date and time will be displayed in the *Date and Time Setting* field.
2. To change the date/time, set the date/time in the dialog box that is displayed by pressing the date and time field.



- Use the following input format to set the date:
yyyy.mm.dd (yyyy: year, mm: month, dd: day)
Set the year using four digits.
Example: Set March 15, 2002 as **2002.3.15**. (Adding 0 prefix to single-digit settings is not required.)
 - Use the following input format to set the time.
hh.mm.ss (hh: hour, mm: minute, ss: second)
Set the year using the 24-hour clock.
Example: Set 06:01:01 p.m. as **18.1.1**. (Adding 0 prefix to single-digit settings is not required.)
5. Press the **Enter** Button to enable the settings.

6-3-7 Printer Type

If there is a printer connected to the PT, select the printer's control method.

Setting item	Details
ESC/P Raster	Sets the printer's control method to ESC/P Raster. Use this setting if mainly using Epson printers.
BJ Raster	Sets the printer's control method to BJ Raster. Use this setting if mainly using Canon printers.
PictBridge	Selected to use a PictBridge-compatible printer.

1. Select either **ESC/P Raster**, **BJ Raster**, or **PictBridge** in **Print Control**.

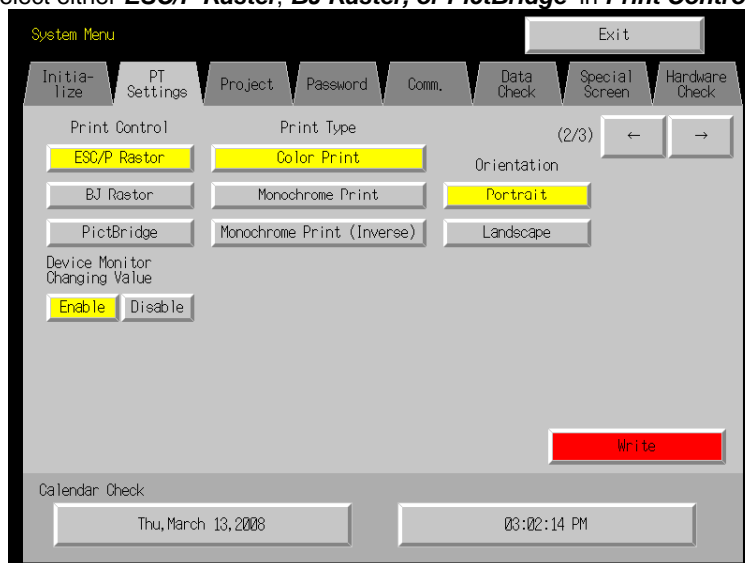

2. After setting, press the **Write** Button to save the setting.

-
- Reference**
- If the print control method is set to PictBridge for system version 8.3 or lower, the print type and orientation will be automatically set as follows and cannot be changed:
 Print type: Color Print
 Orientation: Landscape
 The orientation, however, can be changed in the printer settings with some printers.
 - The print control method is set to PictBridge and cannot be changed for the NS5-□Q1□, NSJ5-□Q1□, NSH5-SQ□10.
-

6-3-8 Printing Mode

Select the printing method of the printer that will be connected to the NS-series PT.

Setting item	Details
Color Print	Prints in color.
Monochrome Print (See note 1.)	Prints in monochrome.
Monochrome Print (Inverse) (See note 1.)	Prints in inverted monochrome.

Note 1: If PictBridge is selected, system version 8.4 or higher is required to change these settings.

6-3 PT Settings

1. Select **Color Print**, **Monochrome Print**, or **Monochrome Print (Inverse)** in **Print Type**.

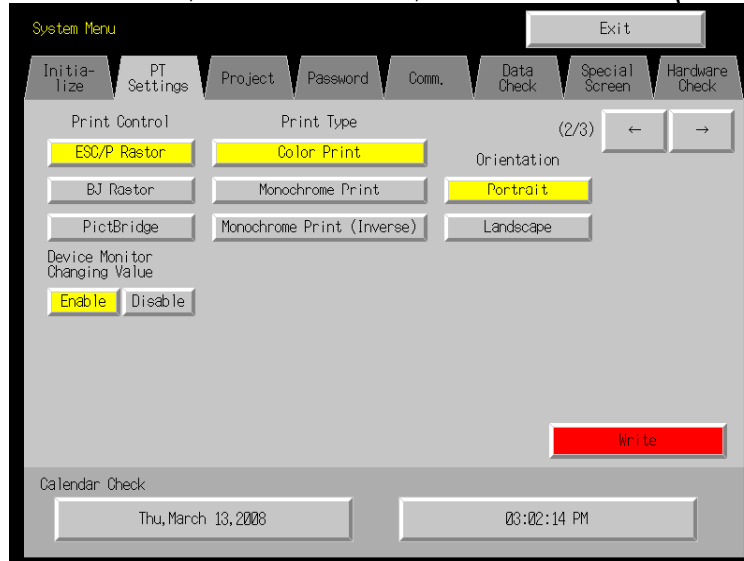

2. After setting, press the **Write** Button to save the setting.

6-3-9 Orientation

Select the printing orientation of the printer that will be connected to the NS-series PT.

1. Select either **Portrait** or **Landscape** in **Orientation**.
Portrait (See note 1.): Prints with the longer page measurement as the height (factory default).
Landscape: Prints with the shorter page measurement as the height.
2. After setting, press the **Write** Button to save the setting.

Note 1: If PictBridge is selected, system version 8.4 or higher is required to change these settings.

6-3-10 Changing Values in Device Monitor Setting

This setting enables using the registered monitor and switch box functions of the device monitor only for monitoring by prohibiting address changes while monitoring.

Disable Button: Prohibits changing monitor values

Enable Button: Enables changing monitor values (factory default)

This setting can also be made with the CX-Designer on the PT Operation Tab Page of the System Settings.

6-3-11 Contrast (NS5-SQ□□/NS5-MQ□□ Only)

This function adjusts the screen contrast. Contrast can be adjusted in 100 degrees.

Adjust the contrast by using operations from the PT Tab Page in the System Menu, as follows:

1. Change the contrast setting using the left and right arrow buttons (<<, <, >, >>) for contrast adjustment. The contrast will change as soon as the buttons are pressed.

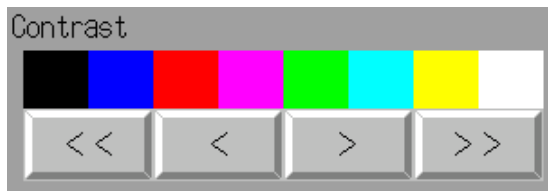

- << Button: Decreases the contrast by ten degrees.
- < Button: Decreases the contrast by one degree.
- > Button: Increases the contrast by one degree.
- >> Button: Increases the contrast by ten degrees.

Check the contrast from the sample display of eight shades above the arrow buttons.

Reference The contrast cannot be adjusted on NS5-SQ□□-V2 PTs with lot number 2110 (January 21, 2010) or later. (The contrast is adjusted to the optimum value in advance.)
Refer to *NS-series PT Lot Numbers on page A-8* for information on lot numbers.

6-3-12 CJK Han Unification Priority

The CJK Han unification setting is used to select what character style (traditional Chinese, simplified Chinese, or Japanese) will be given priority for display.

If Japanese or Chinese is used, the displayed character form will differ even if the character code is the same. In this case, use the CJK Han unification priority setting to select what character style will be given priority for display. Use the following procedure starting from the **PT Settings** Tab in the System Menu to select the priority.

1. In the *CJK Priority* Area, select from *J→C (Simplified) → C (Traditional)*, *C (Simplified) → C (Traditional) → J*, or *C (Traditional) → C (Simplified) → J*.
“J” indicates Japanese and “C” indicates Chinese.

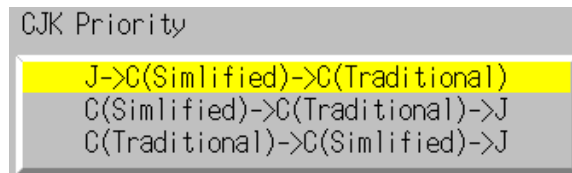

2. After completing the setting, press the **Write** Button. The setting will be saved.

6-3-13 Alarm Monitor Registration Procedure

Set the method for performing monitor registration of alarms and events.

Normally, the method is set to *When switching screens*.

If multiple alarms or events are registered, the screen-switching speed may increase if the *At startup* Option is selected. If there is no difference, set the method to *When switching screens*.

Set the alarm monitor registration method by performing the following operation from the PT Tab Page in the System Menu.

1. Set either *At startup* or *When switching screens* for the alarm monitor registration method.

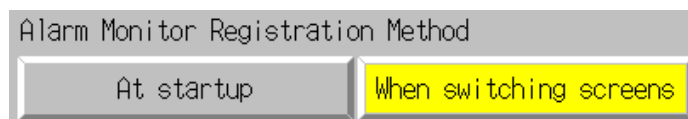

2. After completing the setting, press the **Write** Button. The setting will be saved.

6-3-14 Starting the Ladder Monitor from Alarm/Event Summary and History (NS15/12/10/8 Only)

You can start the Ladder Monitor if an alarm or event is selected in the Alarm/Event Summary and History.

If **ON** is selected, a message to confirm whether to start the Ladder Monitor will be displayed when an alarm or event is selected in the Alarm/Event Summary and History.

1. Select either ON or OFF for starting Ladder Monitor from alarm/event summary and history.



2. After completing the setting, press the **Write** Button. The setting will be saved.

-
- Reference**
- Refer to the *NS-series PT Programming Manual* for information on the alarm/event summary and history.
 - With Ladder Monitor version 3.0 or higher, the system will automatically search for the communications address of the selected alarm or event when the Ladder Monitor starts.
-

6-3-15 Setting the Tag Update Notification Message

If tags are used by projects in the NS-series PT, tags will be automatically verified when ladder data is downloaded to the host. Set whether to display a confirmation message before the system starts to verify the tags.

Make the setting on the PT Operation Tab Page in the System Menu.

1. Select either **Display** or **Hide** for the tag update notification message setting.



-
- Reference**
- Refer to *6-11 Verifying Tags* for information on verifying tags.
 - Tags can be used when connected using EtherNet/IP to a CPU Unit with a built-in EtherNet/IP port.
-

6-3-16 Time to Switch to System Menu (NS12, NS10, NS8, or NS5)

With a NS12, NS10, NS8, or NS5 PT, the time required to switch to the System Menu when two of the four screen corners are pressed can be set. A longer time can be set to help prevent unintentional access to the System Menu.

The time to switch to the System Menu can be set to between 0 and 5 s.

Set the time using the following procedure from the PT Settings Tab Page in the System Menu:

1. Set the time in seconds in the Time to keep pressing 2 corners on the screen [sec] for Entering System Menu Field. Press the field and enter the time from the dialog box that is displayed.

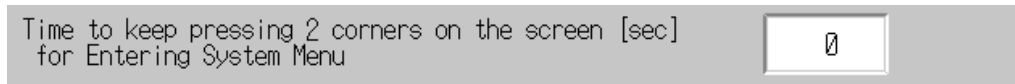

2. After setting, press the Write Button to save the setting.

6-3-17 Double-touch Interval (NS15 Only)

With the NS15, one corner of the screen must be touched twice in a row to move to the System Menu. The interval between the touches is called the double-touch interval and it can be set to between 500 and 1,500 ms. The default setting is 1,000 ms. The display will change to the System Menu if any corner of the screen is pressed twice within this interval. If switching to the System Menu is difficult, increase the interval.

Perform the following procedure from the PT Operation Tab Page of the System Menu.

1. Set the desired value for the double-touch interval in milliseconds. An input dialog box will be displayed when the input field for the setting is touched.

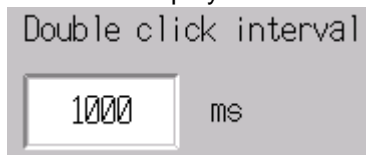

2. Press the **Write** Button. The setting will be saved.

6-3-18 Analog RGB Output (NS15 only)

Set whether to use the analog RGB output. The default setting is *Disable*. Use the following procedure from the PT Settings Tab Page of the System Menu to set the analog RGB output.

1. Set the analog RGB output to either *Enable* or *Disable*.

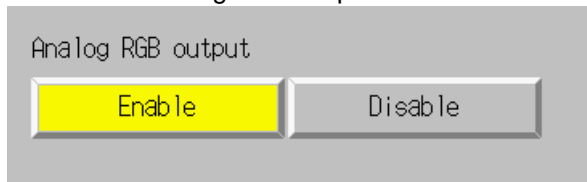

2. Press the **Write** Button to save the setting.

Precautions for Correct Use

- Even when the analog RGB output is set to *Use*, the analog RGB output will stop if a screen with an analog RGB video display object is displayed on the PT.
- When using the analog RGB output, if a screen with an object that switches display colors is displayed on the PT, the image on the screen may be distorted.

6-4 Project Settings

The Project Tab Page is used to display and set the following functions.

- Project title
- Number of labels
- Initial screen
- Initial label
- Barcode input when using keypad:
This setting is used to disable data input from barcodes when the keypad is being used.
- Alarm/event history recording method:
Method for recording log of generated and deleted alarms/events.
- Data log recording method:
Method for recording log of changes to addresses.
- Operation log recording method:
Method for recording log of functional object operations, screen switching, and macro executions.
- Error log recording method:
Method for recording log of macro execution errors.
- System memory:
The addresses allocated in system memory will be displayed.

The screenshot shows the 'System Menu' interface with the 'Project' tab selected. The 'Project Title' field displays 'Test project'. Other settings include 'No. of Labels' set to 5, 'Initial Screen' set to 1, and 'Initial Label' set to 2. The 'Bar-Code input when using keypad' option is currently set to 'Enable'. The recording methods for Alarm/Event, Data Log, Oper. Log, and Error Log are all set to 'Use Ring Buffer (fixed)'. System memory addresses are listed as \$SB: Host:HOST 1, Address: C1000100 and \$SW: Host:HOST 1, Address: DM00100.

6-4-1 Project Title

This function displays title of projects that are registered in the PT. The title is read-only and cannot be edited.

6-4-2 Number of Labels

Multiple label data can be created in each project. This function displays the number of labels set for the project that is registered in the PT.

The number of labels is read-only and cannot be edited.

-
- Reference**
- For details on setting multiple labels for a project, refer to *System Settings and Project Properties* in the CX-Designer's Online Help.
 - Refer to Labels in *2-8 Common Functional Object Functions* in the Programming Manual for information on how to set multiple labels for a functional object.
-

6-4-3 Initial Screen

This function displays and sets the screen number of the screen that is first displayed when the PT is started.

Display and set the initial screen number by using operations from the Project Tab Page in the System Menu, as follows:

1. The number of the screen that is displayed when the PT is started is displayed in the initial screen field.
2. To change the initial screen number, input the value using the tenkey, which is displayed by pressing the display area.
3. After setting, press the **Write** Button to save the setting.

Reference The initial screen number can also be set from the CX-Designer.

6-4-4 Initial Label

This function displays and sets the label number that is shown on the screen when the PT is started.

Reference This initial label number can also be set from the CX-Designer.

6-4-5 Barcode Input When Using Keypad

You can disable data input from barcodes when the keypad is being used.

Reference The setting for data input from barcodes when the keypad is being used can also be made from the CX-Designer.

6-4-6 Alarm/Event History Recording Method

This function displays the method for recording the alarm/event histories. The alarm/event history recording method is read-only and cannot be edited.

This alarm/event history recording method is set from the CX-Designer.

If a ring buffer is used, when the specified number of records is exceeded, the oldest data is deleted and the new data is recorded.

If the ring buffer is not used, the PT stops collecting history data when the specified number of records has been reached. Initialize the alarm/event histories to reopen the history records.

Reference Refer to *6-2-2 Initializing or Saving the Alarm/Event History* for details on initializing the alarm/event histories.

6-4-7 Data Log Recording Method

This function displays the data log recording method.
The data log recording method is read only and cannot be edited.
The use of a ring buffer for the data log recording method is fixed.
When the specified number of log entries is exceeded, the oldest data is deleted and the new data is recorded.
Use the CX-Designer to set the number of log entries.

Reference Refer to 6-2-3 *Initializing and Saving Data Log* in this manual and Data Log Function in 2-20 *Special Functions* in the *Programming Manual* for details on the data log.

6-4-8 Operation Log Recording Method

This function displays the method for recording the operation log. The operation log recording method is read only and cannot be edited. This operation log recording method is set from the CX-Designer.
If *Save in Ring Buffer Format* is set, when the specified number of items is exceeded, the oldest data is deleted and the new data is recorded.
If the log is not saved in ring buffer format, the PT stops collecting log data when the specified number of items has been reached. Initialize the operation log to reopen the record.

Reference Refer to 6-2-4 *Initializing and Saving the Operation Log* in this manual and Operation Log Function in 2-20 *Special Functions* in the *Programming Manual* for details on the operation log.

6-4-9 Error Log Recording Method

This function displays the error log recording method. The error log recording method is read only and cannot be edited. The use of a ring buffer for the error log recording method is fixed.
When the maximum number of items is exceeded, the oldest data is deleted and the new data is recorded.

Reference Refer to 6-2-5 *Initializing and Saving the Error Log* in this manual and Error Log Function in 2-20 *Special Functions* in the *Programming Manual* for details on the error log.

6-4-10 System Memory

The system memory is used to control the PT and exchange information between the host and the PT, such as notifying the host of PT status. The system memory can be allocated to host addresses or to PT memory.
Allocating the system memory as host addresses allows operations such as controlling the PT from the host. The allocated location in the host is displayed in the System Memory and cannot be edited.
The location where the system bit memory and system word memory is allocated (allocated host and address) is displayed in the System Bit Memory (\$SB) and System Word Memory (\$SW).

Reference Refer to 2-4 *System Memory* in the *PT Programming Manual* for details on the system memory.

If the system memory has been set to NT compatibility, allocations for the Control Area, Notification Area, and Window Control Area will be displayed.

6-5 Setting Passwords

The NS-series PT's password function is divided into the following two functions.

- Password Function
Requires a password input before allowing operations on a password-protected functional object.
- Password with Levels Function
Requires a password for authentication when performing operations on a password-protected functional object for the first time. Once authentication has been completed, operations can be performed on all functional objects of the same or lower password levels. Operations cannot be performed on functional objects protected with higher-level passwords.

The passwords are set from the CX-Designer and up to five passwords (5 levels) can be set for a single project. The passwords can be set and changed from the System Menu.

Reference When Indirect Password Specification is used, these settings can not be changed on the NS Unit.

6-5-1 Changing the Password

Perform the following procedure from the System Menu to change the password.

1. Select the **Password** Tab.

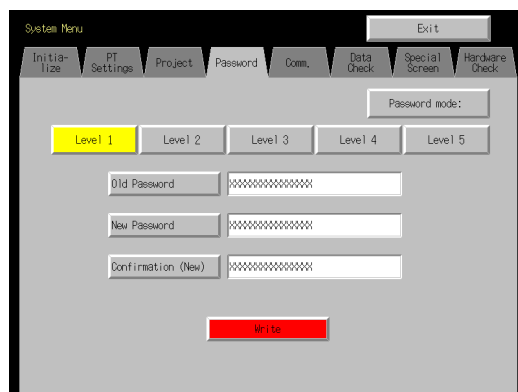

2. Select the password to be changed using the **Level 1** to **Level 5** Buttons.
3. Input the old password and new password in the corresponding fields, and then input the new password again in the confirmation field. Input the password using the virtual keyboard (text input dialog box) that is displayed by pressing the input column.



4. After changing the password, press the **Write** Button to save the setting. Save separately for each password level that is changed.

Precautions for Safe Use

- When changing passwords, do not reset the PT or turn OFF the power until the write operation has been completed (i.e., the **Write** Button has returned to the status before being pressed). If the password is not saved properly, the screen may malfunction.
- If the password is forgotten, it cannot be checked from the PT. Check the password using the CX-Designer.

6-5-2 Setting the Password Function

Perform the following procedure from the System Menu to set a password.

1. Select the **Password** Tab.

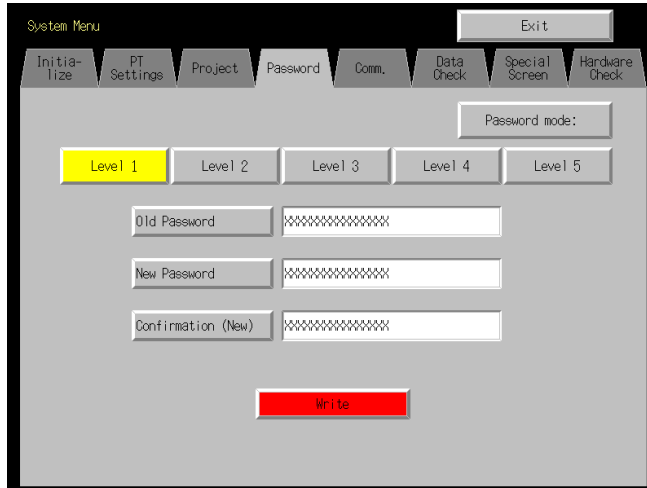

2. Press the **Password mode** Button.

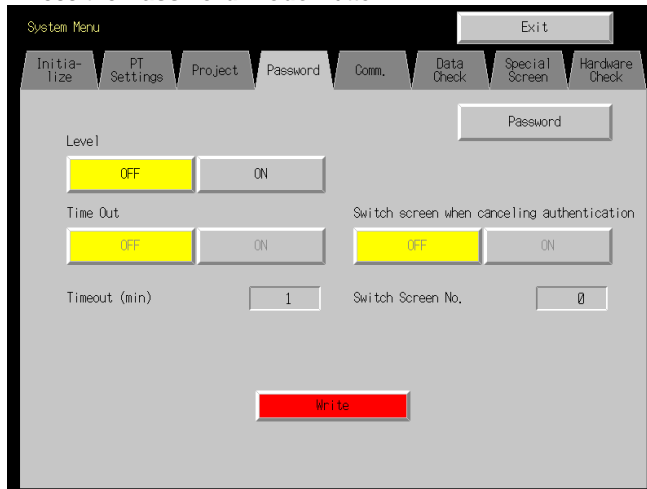

3. After making the required settings, press the **Write** Button to save the settings.

• Settings for the Password Function

The following table describes the password function's setting items.

Setting item	Function
Level	Press the OFF (password) or ON (password with levels) Button to select the function.
OFF	Requires a password input before allowing operations on a password-protected functional object.
ON	Requires a password input for level authentication. During a session from authentication to cancellation, the user only can perform operations on functional objects that are allowed for the password level that was input at the start of the session. The user cannot perform operations on functional objects at higher levels.
Time Out	Click the ON or OFF Button to specify whether authentication is automatically canceled (timed out) after a set time has elapsed. This option can be set when the password with levels function has been turned ON.
ON	A user is automatically timed out if there are no functional object operations within the timeout time.
OFF	Authentication is not automatically canceled. To cancel authentication, press a command button set for cancellation.
Timeout (min)	When the <i>Time Out</i> Option is set to <i>ON</i> , this setting specifies the timeout time in minutes (1 to 60 minutes).
Switch Screen when canceling the authentication	Click the ON or OFF Button to specify whether the screen is automatically switched to a specified screen when a user logs out. This option can be set when the password with levels function has been turned ON.
ON	The screen is switched to the specified <i>Switch Screen No.</i> when authentication is canceled.
OFF	The screen is not switched when authentication is canceled.
Switch Screen No.	If switching the screen when authentication is canceled has been turned ON, the screen is changed to the screen number set here when authentication is canceled.

Reference The password settings can also be made from the CX-Designer.

Precautions for Safe Use

- When changing passwords, do not reset the PT or turn OFF the power until the write operation has been completed (i.e., the **Write** Button has returned to the status before being pressed). If the password is not saved properly, the screen may malfunction.
 - If the password is forgotten, it cannot be checked from the PT. Check the password using the CX-Designer.
-

6-6 Communications Settings

The methods for setting the communications conditions with the host are described here.



6-6-1 Communications Conditions

Set the communications conditions by using operations from the Comm. Tab Page in the System Menu, as follows:

After inputting the communications conditions, press the **Write** Button to save the settings.

Changed settings are enabled after the PT is restarted.

● Communications Conditions Setting Items

The setting items for the communications conditions between the PT and host are as follows:

● Communications Auto-return

Select whether or not to use communications auto-return using the **ON** and **OFF** Buttons.

ON: The PT will automatically return to RUN mode when a communications error occurs, without displaying an error message dialog box.

OFF: The PT will stop running when a communications error occurs and an error message dialog box will be displayed. Press the **OK** Button in the error message dialog box to return to RUN mode. The default setting is OFF.

● Time-out Interval

Set the time before a timeout error occurs when a response is not received from the host. The timeout interval can be set to between 1 and 10 (unit: s). Input the value by using the tenkey or the Up (Δ) and Down (∇) buttons that are displayed by pressing the display area. The default setting is 3 s.

Precautions for Safe Use

Set the time-out interval to 3 s min. when using 1:N NT Links. If the time-out interval is less than 3 s, abnormal communications may occur.

● Retry Counts

Set the number of retries for communications before an error screen will be displayed, when a communications error occurs while communicating with the host. If communications are unsuccessful after the number of communications retries specified here have been executed,

processing set for the communications auto return will be executed. The number of retries can be set to between 0 and 255 times. Input the value by using the tenkey or the Up (Δ) and Down (∇) buttons that are displayed by pressing the display area.

The default setting is 5 retries.

Precautions for Safe Use

Set the retry counts to 5 retries min. when using 1:N NT Links. If less than 5 retries is set, abnormal communications may occur.

● Port Communications Method and Communications Type

Set the communications method for serial ports A and B, for Ethernet and for Controller Link. The right half of the screen will change according to the settings.

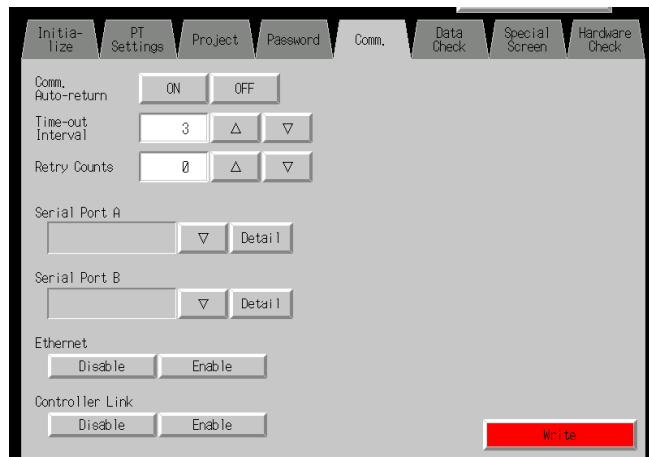

Reference

- To change the communications method for another port, the **Write** Button must be pressed before continuing. The settings will not be saved if the communications method is switched without pressing the **Write** Button.
- For details on Temperature Controller and Memory Link setting methods and other procedures, refer to the *NS Series Host Connection Manual* (Cat. No. V085).
- For details on Host Link setting methods and other procedures, refer to the *NS Series Host Connection Manual (Host Link)*.

● Supported Communications Method Combinations

It is not possible to connect to a PLC via NT Link (1:N) with both serial ports A and B at the same time. It is not possible to use a Bar Code Reader with both serial ports A and B at the same time. It is also not possible to use a modem with both serial ports A and B at the same time.

Serial ports A and B, Ethernet and Controller Link can be used in any combination with other communications methods.

Serial ports A and B, Ethernet and Controller Link, however, cannot be all used simultaneously (except when using a Bar Code Reader).

Reference Serial ports A and B, Ethernet and Controller Link can be set to be used simultaneously, but proper operations cannot be guaranteed (except when using a Bar Code Reader). Therefore, do not set all the ports to be used simultaneously.

● Interface Setting (NS5 Only)

A setting in the System Menu for the NS5 enables switching serial port B between using the expansion interface connector and the serial port B interface connector. Communications will not be possible with the CX-Designer through the serial port B connector if the expansion

6-6 Communications Settings

interface is selected.

The use of the expansion interface is for future expansion and cannot yet be used. Always use the serial port B connector. (The default setting is *Disable*.)

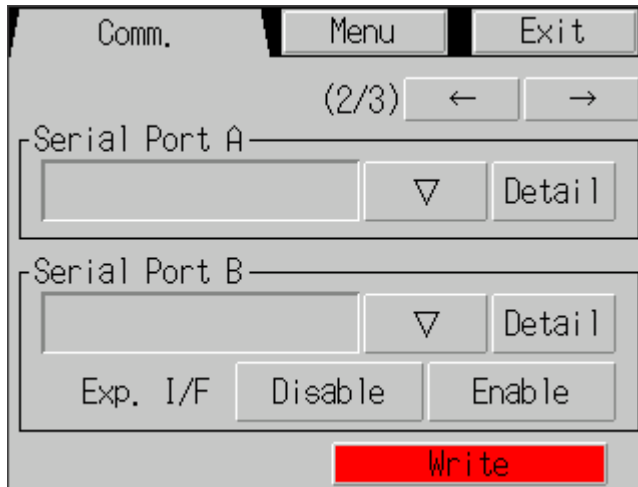

● Status of the RS-232C/RS-422A Selector DIP Switch (NS15 Only)

A DIP switch can be used on the NS15 to change the communications protocol for serial port B between RS-232C and RS-422A. Refer to *3-11 RS-232C/RS-422A Selector DIP Switch* for the switch setting procedure. The default setting is for RS-232C.

The current setting of the RS-232C/RS-422A selector DIP switch is displayed on the System Menu as shown below.



6-6-2 Setting 1:1 NT Link

Select the **Comm.** Tab from the System Menu, and select *NT Link 1:1* (1:1 NT Link) as the communications method for serial port A or B.

After setting, press the **Write** Button to save the setting.

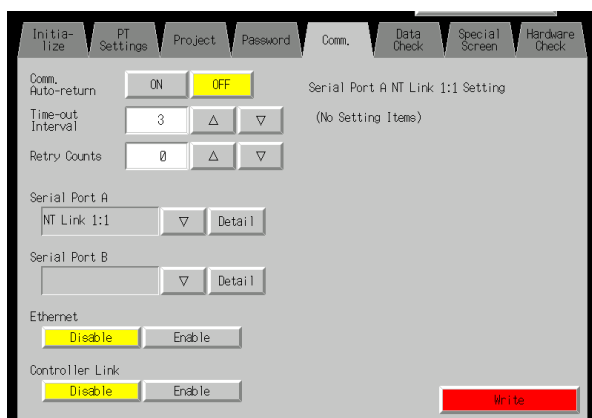

When 1:1 NT Link is selected, there are no details settings.

6-6-3 Setting High-speed 1:N NT Links (Standard, High-speed)

Select the **Comm.** Tab from the System Menu, and select *NT Link 1:N* (1:N NT Link) as the communications method for serial port A or B.

Press the **Detail** Button to display the setting items for high-speed 1:N NT Links on the right side of the screen. Set the unit number and communications speed.

After setting, press the **Write** Button.

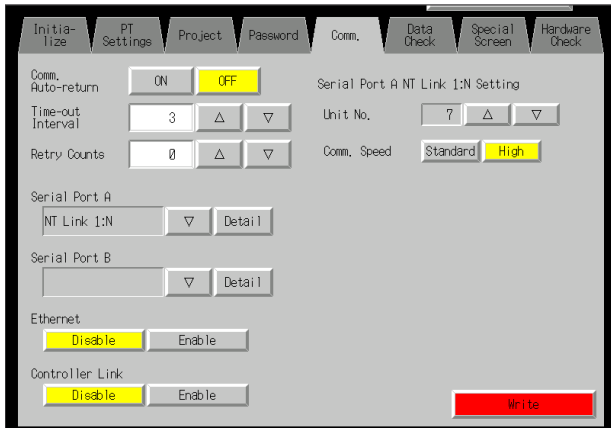

- **Communications Conditions for 1:N NT Links**

Setting item	Function	Settings
Unit number	Sets the unit number.	0 to 7
Communications Speed	Sets the baud Communications speed.	Standard, high-speed

Reference

- The unit numbers that can be set depend on the type of host used, as follows:
 - C200HE(-Z):
Unit numbers 0 to 3 (up to four PTs for each port of the host)
 - C200HG(-Z), C200HX(-Z), CS1G/H, CS1G/H-H, CQM1H, CJ1G, and CJ1G/H-H:
Unit numbers 0 to 7 (up to eight PTs for each port of the host)

Refer to *4-2 1:N Host Connection* for the host settings.
- If the **Detail** Button is pressed for the NS15, the display will switch to the Protocol Setting Dialog Box. Make the settings and press the **Write** Button. Press the **Comm.** Button to return to the Comm Tab Page.

6-6-4 Ethernet and EtherNet/IP Settings

To use Ethernet, select the **Comm** Tab from the System Menu and press the **Enable** Button.

The setting items for Ethernet will be displayed on the right side of the screen. Display and set the network address, node address, IP address, subnet mask, and default gateway. Display the MAC address and IP address table display.

After setting, press the **Write** Button.

6-6 Communications Settings

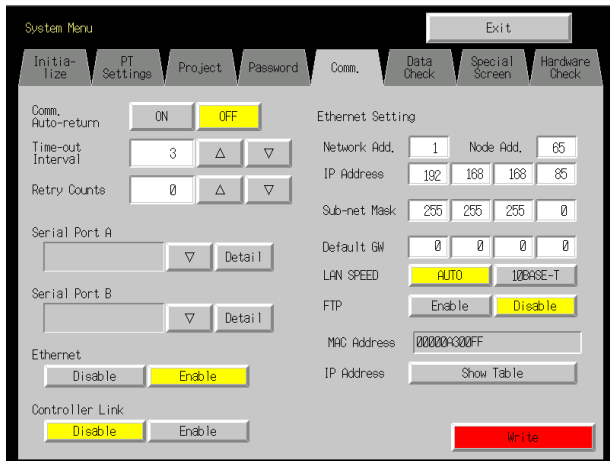

• Setting Ethernet Communications Conditions

Setting item	Function	Settings
Network Add.	Sets the network address used for Ethernet communications.	1 to 127
Node Add.	Sets the local node address.	0 to 254
IP address	Sets the local IP address.	0.0.0.0 to 255.255.255.255 (See note.)
Sub-net	Sets the subnet mask of the local node.	0.0.0.0 to 255.255.255.255
Default gateway	Sets the IP router.	0.0.0.0 to 255.255.255.255
MAC address	Displays the MAC address (device-specific information to identify each device connected to the network.)	Read-only.
LAN SPEED	Selects the method used to set the Ethernet baud rate.	Automatic switch or fixed 10Base-T
FTP	Selects whether or not to use the FTP server.	Enable or disable
IP Address: Show Table	Displays the node numbers and IP addresses of other nodes connected through Ethernet.	Node addresses: 1 to 254 IP addresses: 0.0.0.0 to 255.255.255.255

Note: Do not set the following values for the IP address.
 Host ID with all bits set to 0 or 1 (e.g., **192.168.21.0**).
 Net ID with all bits set to 0 or 1 (e.g., **255.255.21.16**).
 Subnet ID with all bits set to 1 (e.g., **192.168.255.16**).
 IP addresses that begin with 127 (e.g., **127.35.21.16**).

• Host Settings

This setting is used to display detailed data for hosts connected using Ethernet or Controller Link. The host type, network address, and node address for each host can also be changed.

3. Press the **ETN/CLK Host Display** Button. The registered hosts will be displayed in a list.

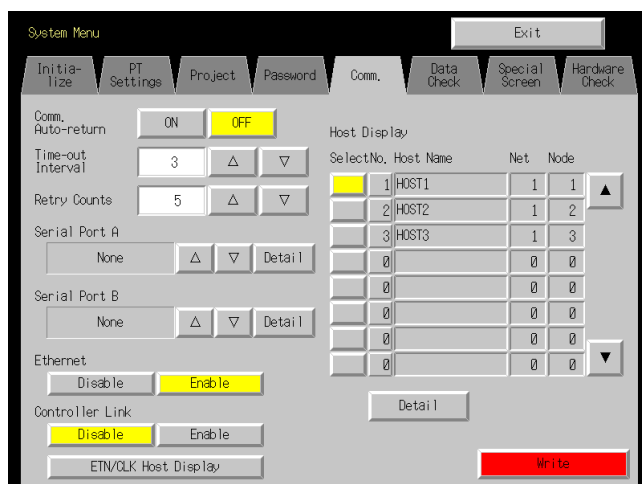

4. Select the host by pressing the button to the left of the host name.
 5. Press the **Detail** Button.
 6. The settings for the selected host can be changed. The settings depend on the communications protocol set in the host.
- Using FINS (Ethernet, Controller Link)
The host type, network address, and node address for the selected host can be changed.

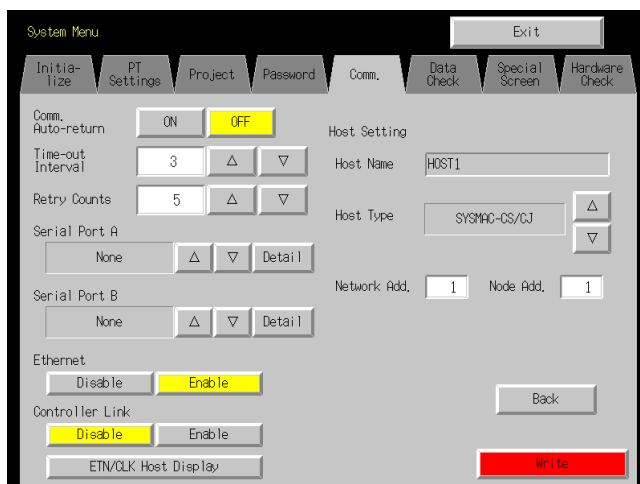

Setting item	Function	Details
Host type	Change the host type by pressing the Up (Δ) and Down (∇) Buttons.	SYSMAC-CS/CJ, SYSMAC-CV, Trajexia, SYSMAC-CJ2, SYSMAC-NJ
Network address	Set the network address of the host.	1 to 127
Node address	Set the node address of the host.	1 to 254

- Using EtherNet/IP
The IP address of the selected host can be changed. The host type and route path are displayed only. They cannot be changed.

6-6 Communications Settings

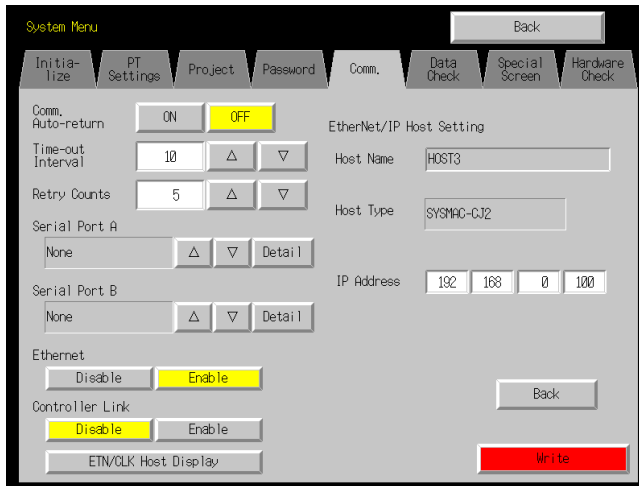

Setting item	Function	Details
Host type	The host type is displayed.	Display only
IP address	Set the IP address of the host (if IP address is selected as the method to specify the communications destination.)	0.0.0.0-255.255.255.255
Route path	The route path of the host is displayed (if route path is selected as the method to specify the communications destination.)	Display only

7. After completing the settings, press the **Write** Button.

6-6-5 Setting the Controller Link Network

If using a Controller Link Network is enabled for the project, settings for the network will be displayed on the right side of window. Set the node address and baud rate (Comm. Speed).

Click the **Write** Button after setting these items. The Controller Link is supported by the NS15, NS12, and NS10 PTs only, and is not supported by the NS8 PTs.

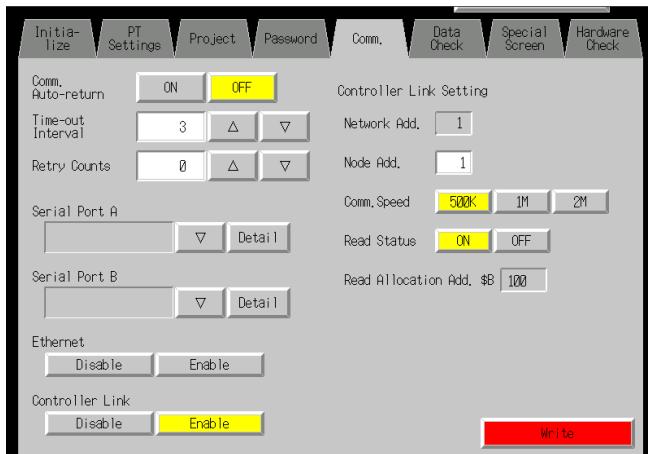

• Setting Communications Conditions for the Controller Link Network

Item	Function	Setting
Network Add.	Displays the network address used for Controller Link.	Display only
Node Address	Sets the local node address.	1 to 32

Comm. Speed	Sets the baud rate.	500K, 1M, or 2M
Read Status	Displays whether Controller Link status is read (display only).	
Read Allocation Add.	Displays address where status is read (display only).	

Note: Using the Controller Link network and the network number cannot be changed at the PT. If you change the setting, display the communications settings in the CX-Designer by selecting **PT – Communication Setting**, change the setting, and then transfer the project to the PT.

6-6-6 Setting Bar Code Readers

The PT has a Bar Code Reader input function allowing input of barcode data as character strings in the String Display & Input object.

The methods for setting the communications conditions with the Bar Code Reader are described here.

Reference • Refer to *3-4 Connecting to Bar Code Readers* for information on methods for connecting Bar Code Readers.

- The Bar Code Reader can be connected to either serial port A or serial port B only.

Set the communications conditions and confirmation method for the Bar Code Reader using the following procedure from the System Menu.

Set the Bar Code Reader's communications method for serial port A or serial port B.

The setting items for the Bar Code Reader will be displayed on the right side of the screen. Set the Communications speed, data bits, stop bits, parity, and input method.

After setting, press the **Write** Button to save the settings.

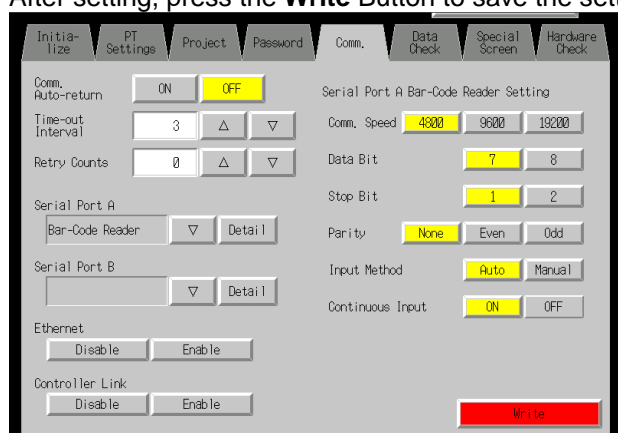

• Setting Communications Conditions for Bar Code Reader Mode

Setting item	Function	Settings
Comm. speed	Sets the communications speed for communications with the Bar Code Reader.	4800, 9600, or 19200 (bps)
Data bits	Sets the data bit length.	7 or 8 bits
Stop bits	Sets the data stop bit length.	1 or 2 bits
Parity	Sets the data parity bits.	None, odd, or even
Input method	Sets the confirmation method used after inputting data in the input column.	Auto or manual confirmation
Continuous input	Sets continuous barcode input to Yes or No.	Yes or No

6-6-7 Modem Settings

Data can be transferred from a personal computer to the PT through a modem. The method used to set the data transfer conditions for the modem is described here.

- Reference**
- Refer to 10-1 PT Transferring Data to the PT in the CX-Designer Operation Manual for details on modem types and connections.
 - The modem can be connected to either Serial Port A or Serial Port B, but not to both at the same time.

Set the communications conditions for the modem from the System Menu using the following procedure.

- Set the communications method for serial port A or serial port B to the modem, and press the **Detail** Button
- The settings for the modem will be displayed on the right side of the screen. Set the communications speed. After the setting is entered, press the **Write** Button to save it.

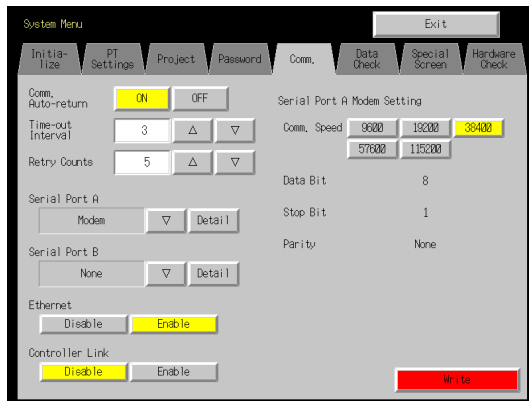

• **Setting Communications Conditions for Modem Data Transfers**

Setting item	Function	Settings
Comm. Speed	Sets the communications speed.	9600, 19200, 38400, 57600, or 115200 (bps)

6-7 Screen Data Check

Registered screens (numbers 0 to 3,999) can be displayed and checked using operations from the System Menu.

- Reference**
- The screen displayed when checking screen data is a sample and cannot be used to communicate with the host. The flicker function is also disabled.
 - Only the user screens (0 to 3,999) can be displayed. System screens cannot be displayed.

Display check screens by using the following procedure from the System Menu.

1. Select the **Data Check Tab**.

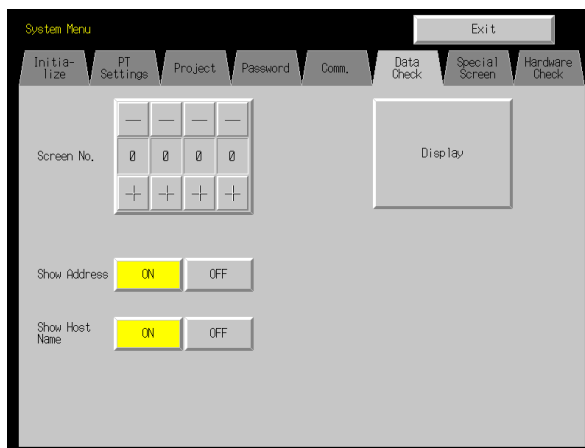

2. Set the screen number and press the **Display** Button to display the screen as a sample.
3. Press the **ON** Button next to the **Show Address** heading and display the sample screen to display the set address instead of the functional object label.
At this point you can also switch between displaying or not displaying the host name by setting **Show Host Name** to ON or OFF.

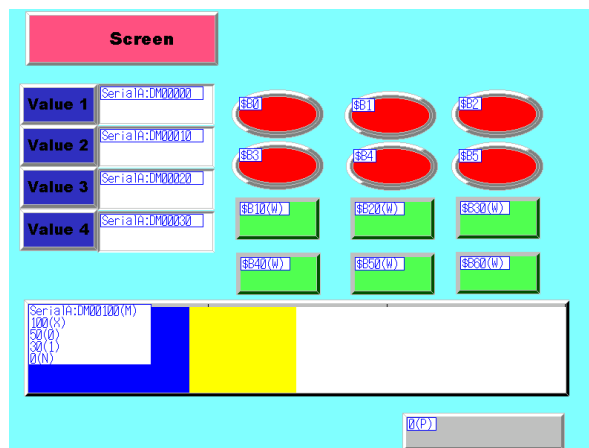

4. Press any part of the sample screen that is displayed to return to the Screen Data Check Screen.

Reference Addresses are not displayed for data block tables.

6-8 Special Screens

These screens are used to display the data histories, device monitor, communications test, and version information.

Item	Function
Alarm history	Displays the alarm history.
Operation log	Displays the operation log.
Error log	Displays the error log.
Special function	Performs the following special functions.
Device monitor	Switches PLC operating modes, displays and changes specified PLC addresses, and displays and deletes PLC error data. Refer to 6-8-4 <i>Device Monitor</i> for information on how to display the Device Monitor Screen. Refer to <i>Device Monitor</i> in 2-20 <i>Special Functions</i> in the <i>Programming Manual</i> for details on the device monitor.
Communications test	Checks the PT communications functions.
Video Configuration	Performs video configuration.
USB device list	Displays a list of the devices connected to the USB port.
Display Capture Data	Displays video capture data or screen capture data stored in a Memory Card.
Transfer Memory Card	Transfers screen data and the system program on the PT to a Memory Card.
PLC Data Trace	Reads the results of a data trace executed in the PLC and displays the results in a time chart. The data trace parameters can also be set.
External applications	Starts external applications.
NJ-series Troubleshooter	Monitors error status and other status in the Controller.
System Version	Displays information on the PT version.

Details on how to use the functions are explained here.

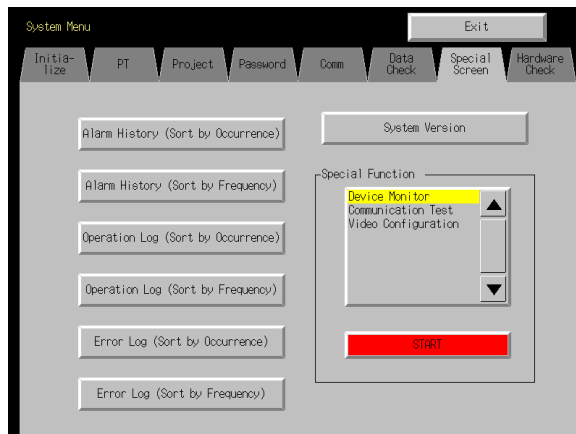

6-8-1 Alarm History

This function displays the alarm history. The alarm history can be displayed in order of occurrence or frequency.

Display alarm history data by using operations from the Special Screen Tab Page in the System Menu, as follows:

1. Press the **Alarm History (Sort by Occurrence)** Button or **Alarm History (Sort by Frequency)** Button to display the history contents.

Alarm History (Sort by Occurrence)

Time of Occurrence	Time of Cancellation	Message
23 Feb, 02 02:45:14		Alarm 1 Occurred
23 Feb, 02 02:45:13	23 Feb, 02 03:08:23	Alarm 2 Occurred
23 Feb, 02 02:45:12		Alarm 3 Occurred
23 Feb, 02 02:45:11	23 Feb, 02 03:08:19	Alarm 4 Occurred
23 Feb, 02 02:45:09		Alarm 5 Occurred

Occurring Unchecked
 Occurring Checked
 Canceled Unchecked
 Canceled Checked

Back

Alarm History (Sort by Frequency)

Latest Time of Occurrence	Latest Time of cancel.	Freq.	Message
23 Feb, 02 04:03:53		4	Alarm 2 Occurred
23 Feb, 02 04:03:52	23 Feb, 02 04:03:28	3	Alarm 3 Occurred
23 Feb, 02 04:03:50		2	Alarm 2 Occurred
23 Feb, 02 04:03:09	04:03:08	5	Alarm 3 Occurred
23 Feb, 02 04:03:14		5	Alarm 1 Occurred
23 Feb, 02 04:03:06	04:03:06	5	Alarm 1 Occurred
23 Feb, 02 04:07:55	04:07:55	2	Alarm 2 Occurred
23 Feb, 02 04:07:47	04:07:47	1	Alarm 2 Occurred
23 Feb, 02 04:07:45	04:07:45	1	Alarm 3 Occurred
23 Feb, 02 04:07:48	04:07:48	1	Alarm 4 Occurred
23 Feb, 02 04:07:38	04:07:38	1	Alarm 4 Occurred
23 Feb, 02 04:07:49	23 Feb, 02 04:07:49	1	Alarm 1 Occurred

Occurring Unchecked
 Occurring Checked
 Canceled Unchecked
 Canceled Checked

Back

2. Press the **Back** Button to return to the Special Screen.

Reference Refer to *Alarm/Event History* in 2-20 *Special Functions* in the *Programming Manual* for details on the alarm history function.

6-8-2 Operation Log

This function displays the operation log. The operation log can be displayed in order of occurrence or frequency.

Display operation log data by using operations from the Special Screen Tab Page in the System Menu, as follows:

1. Press the **Operation Log (Sort by Occurrence)** Button or **Operation Log (Sort by Frequency)** Button to display the operation log contents.

Operation Log (Sort by Occurrence)					
Time of Occurrence	History Type	Message	Item1	Item2	Item3
2008/04/26 09:42:25	Switch		From P:0010	To P:0010	
2008/04/26 09:42:33	Op.	Setting1	Page:0010	Obj ID:0000	Touch ON timing
2008/04/26 09:42:35	Switch		From P:0010	To P:0011	
2008/04/26 09:42:37	Op.	Setting2	Page:0010	Obj ID:0001	Touch ON timing
2008/04/26 09:42:40	Op.	Setting3	Page:0010	Obj ID:0002	Touch ON timing
2008/04/26 09:42:42	Switch		From P:0010	To P:0009	
2008/04/26 09:42:44	Op.	Save	Page:0010	Obj ID:0014	Touch ON timing
2008/04/26 09:42:44	Macro		Page:0010	Obj ID:0014	Touch ON timing
2008/04/26 09:42:45	Op.	Save	Page:0010	Obj ID:0014	Touch OFF timing
2008/04/26 09:42:54	Address	Manual Switch	SERIALA	00100_04	Address ON timing
2008/04/26 09:42:57	Switch		From P:0010	To P:0011	
2008/04/26 09:43:02	Op.	Setting4	Page:0011	Obj ID:0003	Touch ON timing
2008/04/26 09:43:09	Op.	Setting5	Page:0011	Obj ID:0004	Touch ON timing
2008/04/26 09:43:09	Op.	Update	Page:0011	Obj ID:0023	Touch ON timing
2008/04/26 09:43:10	Op.	Update	Page:0011	Obj ID:0023	Touch OFF timing
2008/04/26 09:43:12	Op.	Save	Page:0011	Obj ID:0013	Touch ON timing
2008/04/26 09:43:12	Macro		Page:0011	Obj ID:0013	Touch ON timing
2008/04/26 09:43:12	Op.	Save	Page:0011	Obj ID:0013	Touch OFF timing
2008/04/26 09:43:16	Address	Manual Switch	SERIALA	00100_04	Address OFF timing
2008/04/26 09:43:17	Address	Automatic Switch	SERIALA	00100_05	Address ON timing
2008/04/26 09:43:22	Op.	Run	Page:0011	Obj ID:0021	Touch ON timing
2008/04/26 09:43:23	Op.	Run	Page:0011	Obj ID:0021	Touch OFF timing

Operation Log (Sort by Frequency)					
Freq.	History Type	Message	Item1	Item2	Item3
0005	Op.	Run	Page:0010	Obj ID:0025	Touch OFF timing
0005	Op.	Run	Page:0010	Obj ID:0025	Touch ON timing
0004	Op.	Update	Page:0010	Obj ID:0027	Touch ON timing
0004	Op.	Update	Page:0010	Obj ID:0027	Touch OFF timing
0003	Op.	Stop	Page:0010	Obj ID:0026	Touch ON timing
0003	Op.	Stop	Page:0010	Obj ID:0026	Touch OFF timing
0003	Address	Manual Switch	SERIALA	00100_04	Address ON timing
0003	Op.	Save	Page:0011	Obj ID:0013	Touch OFF timing
0003	Op.	Save	Page:0011	Obj ID:0013	Touch ON timing
0003	Macro		Page:0011	Obj ID:0013	Touch ON timing
0003	Op.	Setting1	Page:0010	Obj ID:0008	Touch ON timing
0003	Address	Manual Switch	SERIALA	00100_04	Address OFF timing
0003	Switch		From P:0010	To P:0009	
0002	Op.	Setting3	Page:0010	Obj ID:0002	Touch ON timing
0002	Op.	Setting3	Page:0010	Obj ID:0002	Touch ON timing
0002	Op.	Setting2	Page:0010	Obj ID:0001	Touch ON timing
0002	Op.	Setting1	Page:0011	Obj ID:0009	Touch ON timing
0002	Op.	Run	Page:0011	Obj ID:0021	Touch ON timing
0002	Op.	Run	Page:0011	Obj ID:0021	Touch OFF timing
0002	Op.	Setting5	Page:0011	Obj ID:0004	Touch ON timing
0002	Op.	Setting5	Page:0010	Obj ID:0021	Touch OFF timing

2. With the NS10, NS8, or NS5, press the **Switch Item** Button to change the items that are displayed.

Operation Log (Sort by Occurrence)					
Time of Occurrence	History Type	Item1	Item2	Item3	
2008/04/26 09:42:25	Switch	Page:0010	Obj ID:0025		
2008/04/26 09:42:33	Op.	Page:0010	Obj ID:0025	Touch ON timing	
2008/04/26 09:42:35	Switch	Page:0010			
2008/04/26 09:42:37	Op.	Page:0010	Obj ID:0027	Touch OFF timing	
2008/04/26 09:42:40	Op.	Page:0010	Obj ID:0026	Touch ON timing	
2008/04/26 09:42:42	Switch	Page:0010			
2008/04/26 09:42:44	Op.	SERIALA	00100_04	Address ON timing	
2008/04/26 09:42:44	Macro	Page:0011	Obj ID:0013	Touch OFF timing	
2008/04/26 09:42:45	Op.	Page:0011	Obj ID:0013	Touch ON timing	
2008/04/26 09:42:54	Address	SERIALA	00000_01	Address OFF timing	
2008/04/26 09:42:57	Switch	Page:0010			
2008/04/26 09:43:02	Op.	SERIALA	00100_04	Address ON timing	

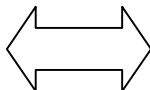

Operation Log (Sort by Occurrence)					
Time of Occurrence	History Type	Message			
2008/04/26 09:42:25	Switch				
2008/04/26 09:42:33	Op.	Setting1			
2008/04/26 09:42:35	Switch				
2008/04/26 09:42:37	Op.	Setting2			
2008/04/26 09:42:40	Op.	Setting3			
2008/04/26 09:42:42	Switch				
2008/04/26 09:42:44	Op.	Save			
2008/04/26 09:42:44	Macro				
2008/04/26 09:42:45	Op.	Save			
2008/04/26 09:42:54	Address	Manual Switch			
2008/04/26 09:42:57	Switch				
2008/04/26 09:43:02	Op.	Setting4			

3. Press the **Save Log** Button. The operation log data will be saved to the Memory Card as a CSV file.
4. Press the **Back** Button to return to the Special Screen.

Reference • Refer to *6-2-4 Initializing and Saving the Operation Log* in this manual and *Operation Log in 2-20 Special Functions* in the *Programming Manual* for details on the operation log.

- Project versions 8.0 and higher support setting operation log messages.

6-8-3 Error Log

This function displays the macro error history. Macro errors can be displayed in order of occurrence or frequency.

Display error log data by using operations from the Special Screen Tab Page in the System Menu, as follows:

1. Press the **Error Log (Sort by Occurrence)** Button or **Error Log (Sort by Frequency)** Button to display the error log contents.

Error Log (Sort by Occurrence)

Time of Occurrence	Page No.	Object ID	Macro ID	Error Type
23 Feb, 02 23:54:14	0001	0017	0020	Incorrect program
23 Feb, 02 23:54:16	0001	0013	0020	0 division occurs
23 Feb, 02 23:54:25	0001	0017	0020	Incorrect program
23 Feb, 02 23:54:27	0001	0015	0020	B/D code error
23 Feb, 02 23:54:28	0001	0016	0020	Argument value incorrect
23 Feb, 02 23:54:31	0001	0017	0020	Incorrect program

Back

Error Log (Sort by Frequency)

Freq.	Page No.	Object ID	Macro ID	Error Type
0003	0001	0017	0020	Incorrect program
0002	0001	0013	0020	0 division occurs
0002	0001	0015	0020	B/D code error
0001	0001	0016	0020	Argument value incorrect

Back

2. Press the **Back** Button to return to the Special Screen.

Reference Refer to 6-2-5 *Initializing and Saving the Error Log* in this manual and *Error Log* in 2-20 *Special Functions* in the *Programming Manual* for details on the error log.

6-8-4 Device Monitor

The device monitor is an expansion function of the PT. This function is supported by CPM1A, CPM2A, CPM2C, CQM1, CQM1H, C200HS, C200HX/HG/HE(-Z), CS1G/CS1H, CS1D, CS1G/CS1H-H, CJ1G, CJ1M, CJ2H, CJ2M, NJ501, NJ301 and NJ101 PLCs.

The device monitor has the following functions.

- Switches the PLC operating modes.
- Displays, changes, and performs force-sets/resets of current values in specified addresses (registered monitor).
- Displays a list of the current values (continuous monitor) in consecutive addresses (DM, EM, and WR Area words).
- Displays PLC error information (error logs) and deletes the errors (error information).

Details on methods of opening the Device Monitor Screen are explained here. Refer to *Device Monitor* in 2-20 *Special Functions* in the *Programming Manual* (Cat. No. V073) for details on the function and operation methods.

**Precautions
for Safe Use**

Always check carefully that the system is safe before performing the following operations using the device monitor.

- Changing the monitor data and timer/counter current values.
 - Switching operating modes.
 - Performing force-sets/resets.
 - Changing timer/counter set values.
-

The Device Monitor Screen is displayed by using operations from the Special Screen Tab Page from the System Menu, as follows:

1. Select **Device Monitor** from the *Special Functions* List Box, and press the **START** Button.

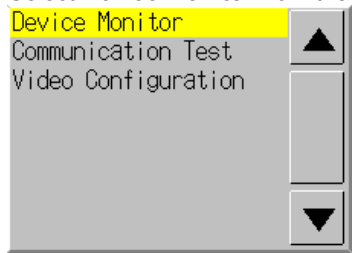

2. The Device Monitor Screen will be displayed.

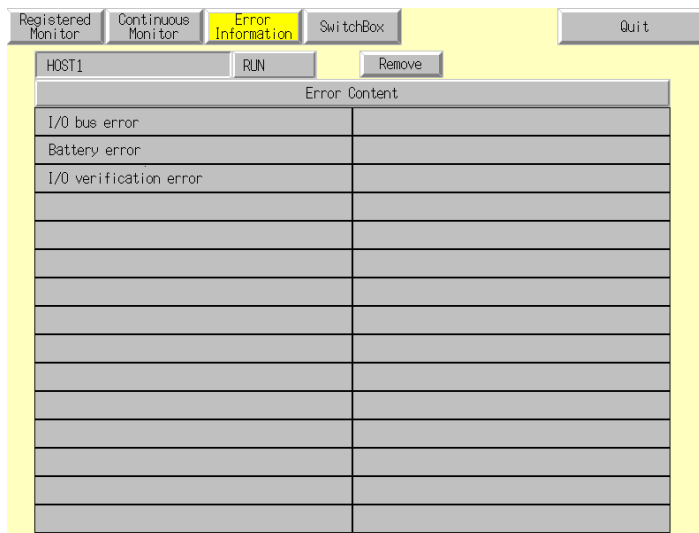

3. Press the **Quit** Button to return to the Special Screen.

6-8-5 Communication Test

This function checks whether communications are enabled, by performing simple communications.

Screen	Method of connection with host
FINS communications test	Serial port Ethernet Controller Link
CIP communications test	EtherNet/IP

Display the Communication Test Screen by using operations from the Special Screen Tab Page in the System Menu, as follows:

1. Select **Communication Test** from the *Special Functions* List Box, and press the **START** Button.

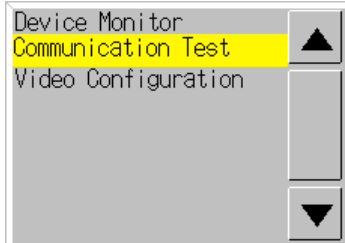

2. Press the **Communication Test** Button to switch to the Communications Test Screen.

A screenshot of the 'Communication Test' screen. At the top, there are tabs for 'FINS' and 'CIP'. The screen contains several input fields and buttons:

- 'Send To (N.n.u.)' field with '0.0.0' entered.
- 'Send Message' field with '2501' entered.
- 'No. of Sends' field with '1' entered.
- 'Receive Timeout' field with '3000 ms' entered.
- 'Received Header' field with 'SID: 0' entered.
- 'Received Message' section with a table of four empty rows.
- 'Comment' field with '0 ms' entered.
- 'Start' button.
- 'Send' and 'Receive' radio buttons.
- 'Back' button.

3. Select either **FINS** or **CIP**.
4. Press the **Back** Button to return to the **Special Window**.

FINS Communications Test

1. Set each of the setting items, as follows:

• Setting and Display Items in Communication Test Screen

Item	Details
Send to	<p>Sets the address of the transmission destination in the format (network address).(node address).(unit number).</p> <p>Sets the following addresses when performing a communications test for a node connected to serial port A or B.</p> <ul style="list-style-type: none"> • Serial port A: 111.1.0 • Serial port B: 112.1.0
Send message	Sets the FINS command being to be sent.
Number of sends	Displays the number of times messages are transmitted. The number of times is fixed to 1.
Receive Timeout	<p>Sets the time before the message timeout occurs. Displays an error message when the timeout time is exceeded after transmission.</p> <p>The setting time is applicable for Ethernet only. For serial communications, the timeout monitor time set from the Comm Tab is used.</p>

2. Press the **Start** Button to start transmission.

The sending indicator will remain lit until the transmission is completed.

After transmission, the Receiving indicator will remain lit until reception is completed.

3. If communications are normal, a response will be received from the transmission destination and the following items will be displayed. Refer to the *FINS Command Reference Manual* (Cat. No. W227) for details on FINS commands and information displayed in comments.

• Display Items in Communication Test Screen

Item	Details
SID (See note 1.)	<p>The SID used for transmission is displayed as a hexadecimal.</p> <p>The SID is incremented between 0 and 0xFF and returns to 0 after 0xFF is exceeded.</p>
Received header	Displays the FINS header that is received. (See note 2.)
Received message	Displays the received message.
ms	Displays the time lapsed in ms from sending the FINS command until receiving the FINS response.
Comment	Displays the status, such as "normal completion," according to the completion code after reception.

Note 1. SID is the source process ID.

2. The FINS header is the header that precedes the FINS command. Refer to the *FINS Command Reference Manual* (Cat. No. W227) for details on FINS commands.

CIP Communications Test

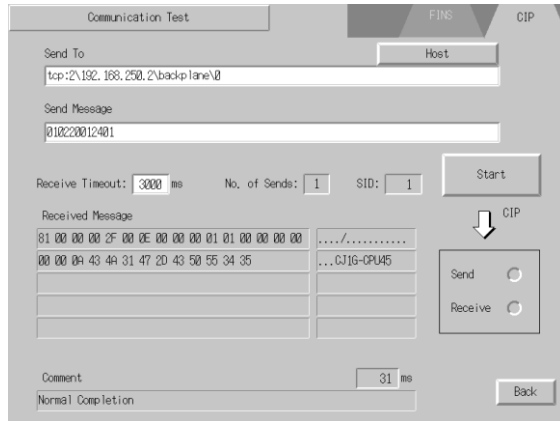

1. Set each of the setting items, as follows:

Item	Details
Send To	Sets route path of the send destination. Also, if you click the Host Button, a list of hosts registered in the project will be displayed. You can select the host of the send destination from the list.
Send message	Inputs an explicit message.
Number of Sends	Displays the number of times messages are transmitted. The number of times is fixed to 1.
Receive Timeout	Sets the time before the message timeout occurs.

- Press the **Start** Button to start transmission.
The sending indicator will remain lit until the transmission is completed.
After transmission, the Receiving indicator will remain lit until reception is completed.
- If communications are normal, a response will be received from the transmission destination and the following items will be displayed.

Item	Details
SID	Displays the identification number of the explicit message.
Received Message	Displays the received message.
ms	Displays the time from sending the command message to receiving the response message.
Comment	Displays the status, such as "normal completion," according to the completion code after reception.

-
- Reference**
- For details on explicit messages, refer to documentation on EtherNet/IP and CIP specifications.
 - To obtain documentation on EtherNet/IP and CIP specifications, contact an ODVA office.
-

6-8-6 Video Configuration

A Video Input Unit can be mounted to the PT to display images by connecting video devices. The user can adjust the image and output signals to a Vision Sensor from this window.

This section describes only the procedure for opening the window. For details, refer to 2-20-10 *Video Configuration* in the *NS Series Programming Manual*.

The Video Configuration Window can be access by selecting the **System Menu** and clicking

the **Special Screen** Tab as shown below.

1. Select **Video Configuration** from the list under *Special Function*, and click the **Start** button.

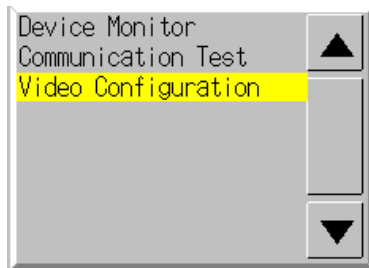

The Video Configuration Window will be displayed.

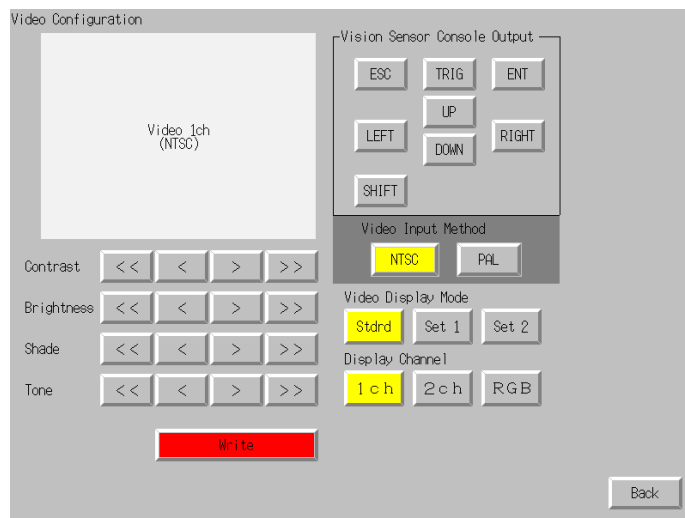

2. Press the **Back** Button to return to the **Special** Window.

Reference Press the **Write** Button to save the adjustments to the displayed image. When starting the PT next time, the saved settings for the adjustments will be automatically reflected on the display.

6-8-7 USB Device List

This function displays information about the devices connected to the PT's USB port.

Item	Details
Device list	A list of the devices currently connected to the USB port is displayed.
Driver list	A list of connectable USB devices that are supported by the NS Series is displayed.

1. Select **USB Device List** from the *Special Functions* List Box, and press the **START** Button.

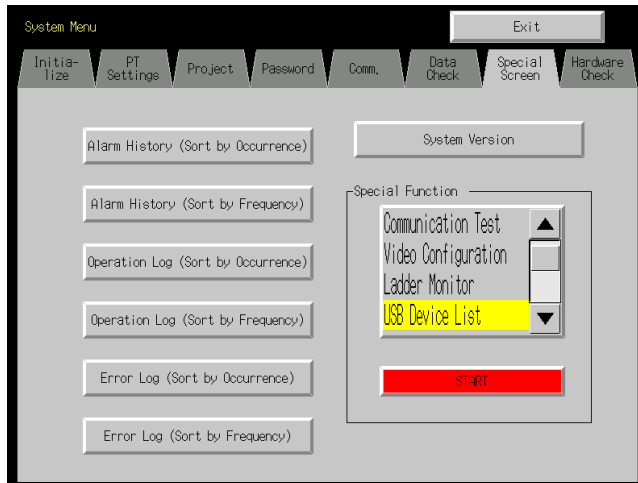

2. The USB Device List Window will be displayed.



A list of USB devices currently connected and a list of USB devices supported by the NS Series are displayed. Press the **Update** Button to reconfirm the connected USB devices and refresh the display.

3. Press the **Return** Button to return to the Special Screen.

Reference The USB Device List Window displays the devices connected to the USB host connector on the PT. A PictBridge-compatible printer connected to the USB slave connector will not be displayed.

6-8-8 Display Capture Data

Video capture data and screen capture data stored in a Memory Card can be displayed. Perform the following procedure under *Special Screen Tab* on the System Menu.

1. Select **Display Capture Data** from the *Special Function List Box* and press the **START** Button.

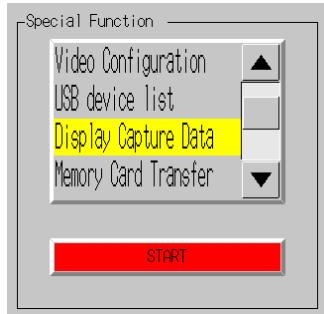

2. The Show The Captured Data Screen will be displayed.

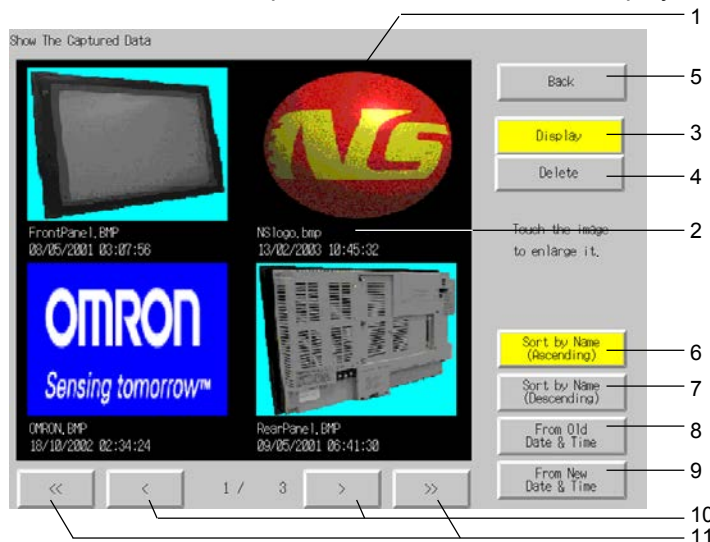

No.	Item	Details
1	Data	Displays a BMP file stored in the LOG/CAPTURE folder in the Memory Card.
2	File name	Display the file name and time stamp of the BMP file.
3	Display	Press the Display Button and then the bitmap to enlarge the display. Press the Print Button to print the BMP file. Press the Full Screen Button to display the BMP file in original format. The original display divided into four areas will return if BACK is pressed.
4	Delete	The following dialog box will appear if the Delete Button and then the bitmap are pressed. <div data-bbox="842 1697 1230 1832" data-label="Image"> </div> Press the Yes Button to delete the BMP. The capture display screen will return if the No Button is pressed.
5	Back	Press to return to the Special Screens Tab Page.

No.	Item	Details
6	Sort by name (Ascending)	Press to sort the bitmap file names alphabetically.
7	Sort by name (Descending)	Press to sort the bitmap file names reversed alphabetically.
8	From Old Date & Time	Press to sort the bitmap file names starting from the oldest one.
9	From New Date & Time	Press to sort the bitmap file names starting from the newest one
10	< Button and > Button	Press to display the next or previous page (4 files) of bitmaps.
11	<< Button and >> Button	Press to display the page back or forward by 3 pages (12 files) of bitmaps.

Reference The following types of data are also displayed for capture data.

- PLC data trace
 - Ladder Monitor
-

6-8-9 Memory Card Transfers

With a Memory Card is inserted into the PT, please perform the following procedures using the Special Screens Tab Page of the System Menu. You can manually transfer screen data and system programs without manipulating the DIP switch on the PT. The Memory Card can be used to transfer data in the following situations.

- To transfer data to or from a Memory Card already inserted to save or read data such as data logs and captured data.
- To transfer data after replacing a Memory Card already inserted to save data such as data logs and captured data with a Memory Card for data transfer.
- To transfer data after inserting a Memory Card to a PT without one.

Perform the following procedures as required by the application.

Transferring Data to a Memory Card in the PT

No special action is required prior to transferring data to the Memory Card.

Replacing a Memory Card in the PT with Another Memory Card Used to Save Data

Use the following procedure to replace the Memory Card already in the PT with another Memory Card that will be used to save data. Perform the following procedure from the Initialize Tab Page of the System Menu. Remove the Memory Card that is currently inserted, and insert another one.

1. Press the **Remove** Button next to *Memory Card* of the Initialize Tab Page.
2. Confirm that it is safe to remove the Memory Card, and remove it from the PT.
3. Insert the Memory Card that will be used to save data into the PT.

Inserting a Memory Card into a PT without One

Insert the Memory Card into the PT.

Transferring Memory Card Data

Use the following procedure from the Special Screen Tab Page of the System Menu to transfer data to Memory Card. Press the **EXIT** Button at the top left of the Memory Card Transfer screen to reset the PT.

1. Select **Memory Card Transfer** from the Special Functions list, and press the **Start** Button.
2. A Memory Card transfer will be executed, and the following screen will be displayed on the PT.

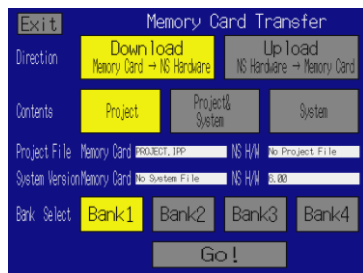

3. Specify the direction (download or upload), contents (Project, Project & System, or System), and banks. The IPP file name and system version that are stored in both the specified bank of the Memory Card and the PT will be displayed in the Project File and System Version Fields. After confirming the details, press the **Go** Button.
4. The following screen will be displayed if data transfer security has been set for the project data stored in the PT to protect the project data in the PT from unauthorized data transfers. Input the password and press the **ENTER** Button.



5. A message confirming the transfer will be displayed. Press the **OK** Button to execute the specified data transfer operation. When downloading, the screen data previously stored in the PT will be deleted. Also, specify whether or not to delete the log data.

Precautions for Correct Use

Always clear the log data for the following.

- When changing settings related to alarms, events, or the data logs.
- When transferring a different project to the PT.

6. A warning message will be displayed if the PT model, system program/screen data versions, or language for the data stored in the PT are different from that for the data stored in the Memory Card. Press the **Yes** Button to continue transferring the data.
7. The uploading/downloading screen will be displayed while data is being transferred. A screen indicating that the transfer has been completed will be displayed when the transfer has finished. (If an error occurs, a transfer error screen will be displayed. Refer to page 3-27 if an error occurs.)
8. The indicator will flash green and the following screen will be displayed when the transfer is completed.



9. If you want to continue using the Memory Card, press the **Reset** Button to reset the PT. If you remove or replace the Memory Card, press the **Reset** Button immediately after removal or replacement to reset the PT.

Precautions for Correct Use

- Please refer to the procedure above for removing a Memory Card when transferring data and always follow the messages displayed on the PT. If a Memory Card is removed at the wrong time, the data that has been transferred may not work properly.
- The data that can be transferred using the Memory Card Transfer operation on the System Menu is only the screen and system program data can be manually transferred with a Memory Card inserted. The DIP switch on the PT must be manipulated to insert a Memory Card and automatically upload/download screen or system program data. Refer to 3-6 *Using Memory Cards* for details.

6-8-10 External Application Startup

This function closes the regular work screen and starts up an external application, such as the Programming Console function or Ladder Monitor.

The following describes the procedure for starting up external applications. Refer to the individual manual for more details on functions and operations applicable to the application.

Start up an external application by using operations from the **Special Screen** Tab in the **System Menu** as follows:

1. Select an external application from the Special Functions List Box, and press the **START** Button. The following diagram shows the screen with Ladder Monitor selected.

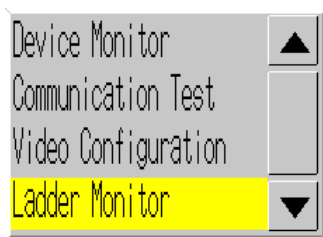

2. The NS-series PT resets.
3. The NS-series PT reboots, and the selected application starts up.

If an application displays a message, refer to its manual.

Reference *Device monitor*, *Communication Test*, *Video Configuration*, *USB Device List*, *Display Capture Data*, and *PLC Data Trace* are not external applications. The screen in the **System Menu** switches when you press the START button with one of these selected, but the NS-series PT does not reset.

- For information on the Ladder Monitor, refer to the *Ladder Monitor Operation Manual* (Cat. No. V082). The *Ladder Monitor Operation Manual* is provided as a PDF file with the CX-Designer.

CX-Designer

CD-ROM: \Utility\English\LadderMonitorFunc\V082.pdf

If you cannot obtain a copy of the manual as a PDF file, consult your OMRON representative.

- For details on programming functions, refer to the *NS-Series PT Programming Manual*.
-

6-8-11 Version Display

This function displays information on the PT version.

Display the Version Display Screen by using operations from the **Special Screen** Tab Page in the System Menu, as follows:

1. Press the **System Version** Button to switch to the Version Display Screen.
2. The product model and version will be displayed.



3. Press the **Back** Button to return to the Special Screen.

6-8-12 PLC Data Trace (NS15, NS12, NS10, and NS8 Only)

The PLC Data Trace function uses the data trace function within a CS/CJ-series PLC (CPU Unit) and displays the results of the PLC's data trace at the PT.

After receiving the data trace execution command from the NS-series PT and establishing the specified trigger condition, the PLC reads the specified bit's status or present value of the specified word according to the sampling conditions, and stores the sampled data in the CPU Unit's Trace Memory.

The PT reads the data stored in the PLC and displays that data on the screen as a time chart.

The PLC Data Trace function can be used in the NS15, NS12, NS10, and NS8 PTs only.

6-8 Special Screens

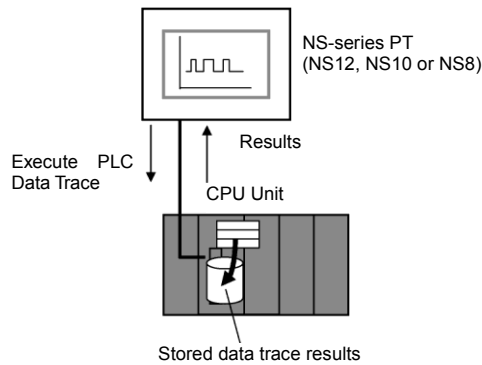

This section only explains how to open the PLC Data Trace Screen. Refer to *2-20 Special Functions* in the *NS Series Programming Manual* for details on the specifications and operation of the data trace function.

Precautions for Correct Use

The data trace function is supported by the CS/CJ-series PLCs (except CP-series PLCs). This function cannot be used with other PLC models.

Display the PLC Data Trace Screen by using operations from the Special Screen Tab Page in the System Menu, as follows:

1. Select **PLC Data Trace** from the *Special Functions* List Box, and press the **START** Button.

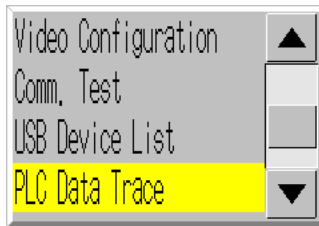

2. The PLC Data Trace Screen will be displayed.

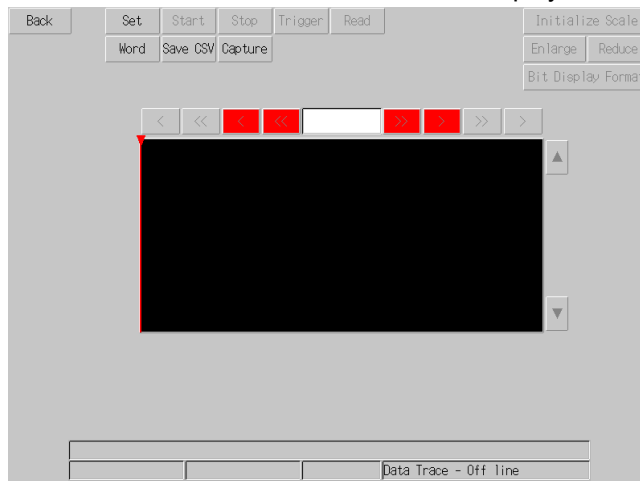

3. Press the **Back** Button to return to RUN mode.

6-8-13 NJ-series Troubleshooter

The NJ-series Troubleshooter is used to monitor the error status in an NJ/NX-series CPU Unit and to display that status on an NS-series PT.

The procedure to open the Troubleshooter Screen is given here. For details on functions and operating methods, refer to *NJ-series Troubleshooter* in *2-20 Special Functions of the NS-Series PT Programming Manual*.

The Troubleshooter is supported by NJ/NX-series Controllers. It cannot be used for other Controllers or PLCs. Perform the following procedure from the Special Screen Tab Page of the System Menu to display the Troubleshooter.

1. Select **Troubleshooter (NJ)** from the list of special functions and press the **START** Button

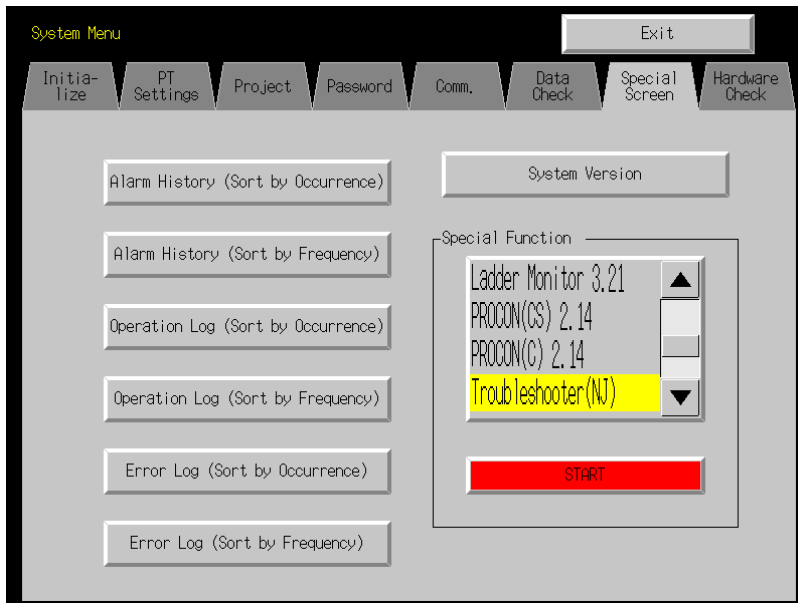

2. The Troubleshooter Screen will be displayed.



3. Press the **Back** Button to return to RUN mode.

6-9 Hardware Check

The hardware check is used to check the following functions.

Item	Function
LCD check	Checks the LCD.
Touch switch check	Checks touch panel input.
Touch panel Calibration (NS15 only)	Calibrates the touch positions.



6-9-1 LCD Check

This function checks whether the LCD (screen display) is operating normally.

Check the LCD by using operations from the Hardware Check Tab Page in the System Menu, as follows:

1. Press the **LCD Check** Button to switch to the LCD Check Screen.

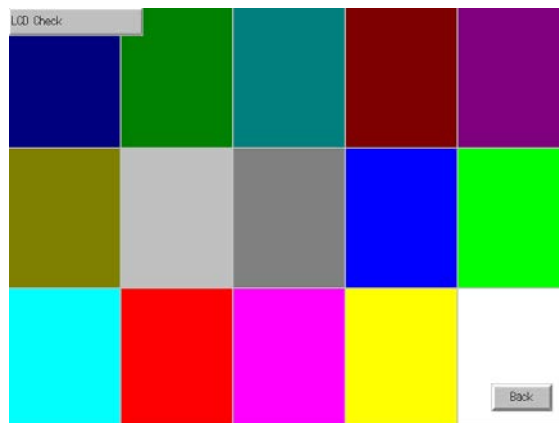

2. Press the **Back** Button to return to the Hardware Check Screen.

6-9-2 Touch Switch Check

This function checks whether the touch switches are operating normally.

Check the touch panel by using operations from the Hardware Check Tab Page in the System Menu, as follows:

1. Press the **Touch Switch Check** Button to switch to the Touch Switch Check Screen.
2. Press the screen. If the part of the screen touched is shown in inverse display, the touch switch is operating normally.

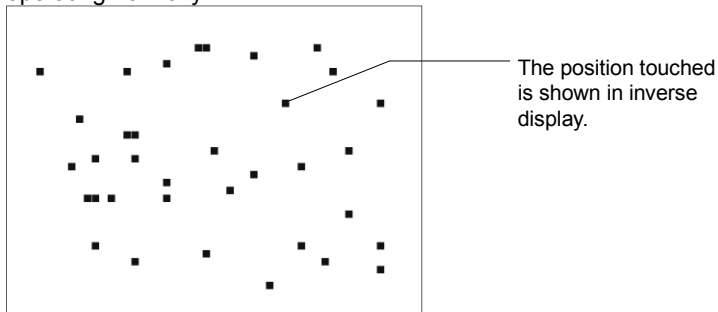

3. Press the button in the top right corner to return to the Hardware Check Screen.

Reference Two points cannot be touched at the same time on the Touch Panel Check Screen.

6-9-3 Touch Panel Calibration (NS15 Only)

This function calibrates the touch positions on the touch panel. Use the following procedure from the Hardware Check Tab Page of the System Menu to perform the calibration.

1. Press the **Touch panel Calibration** Button. The Calibration Display will appear.

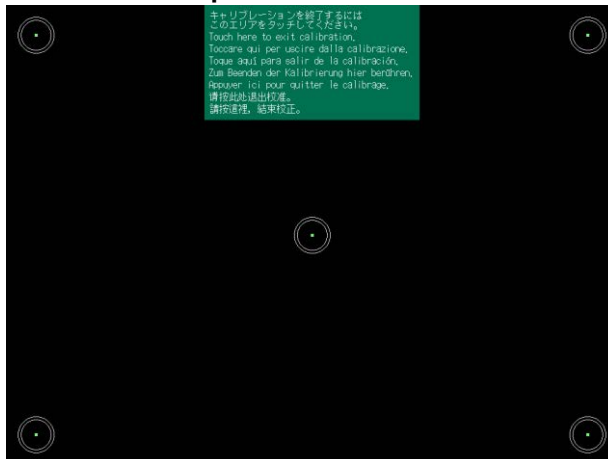

2. Press the marks in the four corners of the screen and the mark in the center of the screen. The marks may be pressed in any order.
3. The touch positions will be calibrated.
4. Press the blue button at the top of the display. The Hardware Check Tab Page will be displayed again.

6-10 Starting Operations

The host and PT connected to it start operating after the project data has finished being transferred and the System Menu settings (communications conditions with the host, etc.) have been completed.

**Precautions
for Safe Use**

Start actual operation only after sufficiently checking the operation of the screen data and host programming.

● Switching to RUN Mode and Starting Up

Pressing the Exit Button at the top right of the screen in the System Menu will display the screen that was displayed before moving to the System Menu, change the status to RUN mode, and start running the PT. The pop-up screens that were open before switching to the System Menu, however, will not be displayed.

Reference The error message indicating a project read error will be displayed if the System Menu is closed while screen data is being initialized. Always transfer the screen data from the CX-Designer or Memory Card after initializing screen data.

● Checking Communications with the Host

Execute the host program and check that the following operations are normal.

- Check that the PT screens will switch according to the host program.
If the screen displays cannot be switched normally, check whether the PT and host are connected properly, and whether the hardware settings are correct. For details, refer to *Section 4 Connecting the Host to Serial Port* or *Section 5 Connecting to Host via Ethernet or Controller Link*.
- Use the Support Software (CX-Programmer, etc.) to display the details on words and bits to check that the results of PT button operations and numerical/character string input operations have been properly transmitted to the host.
- If the operation results are not transmitted to the host properly, check the object settings. Refer to the object descriptions in the *PT Programming Manual* for details on object settings.

● Communications Not Established with Host

Use the following procedure to check communications if the PT and host are not communicating normally.

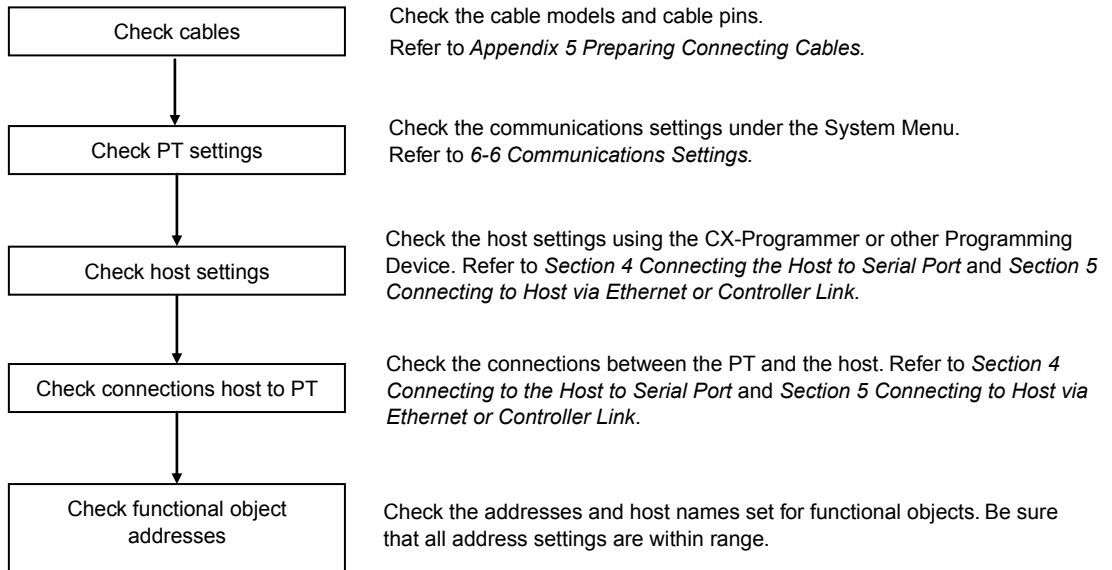

Precautions for Correct Use

The whole system may stop, depending on the method used to turn the power ON and OFF. Always follow the specified procedure when turning the power ON or OFF.

6-11 Verifying Tags

If tags are used by projects in the NS-series PT, verification will be performed to check whether the tag settings match the host tag settings (i.e., network variables).

Tags will be verified in the following cases.

- When the NS-series PT is started
- When ladder data is downloaded to the host (i.e., tag settings are updated)

1. The following screen will be displayed when the NS-series PT is started or ladder data is downloaded to the host.

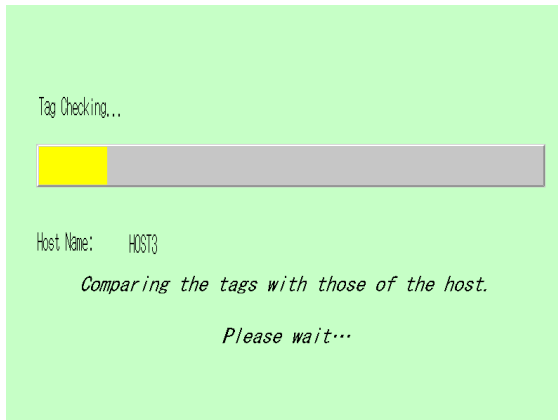

2. When verification has been completed, the user screen will be displayed if the tags of the NS-series PT and the host match.
3. If the tags do not match, the Tag Comparison Results List will be displayed.

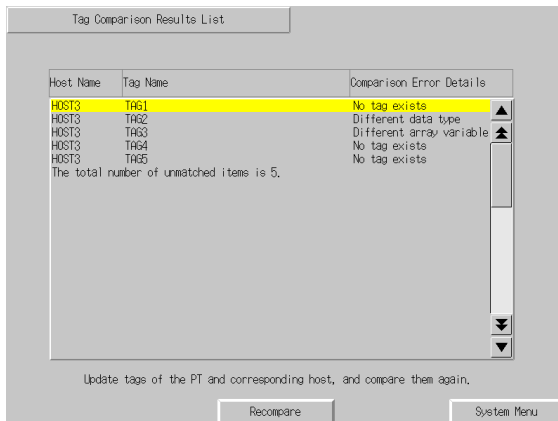

The following will be displayed in the *Verification Error Details* Column.

Item	Details
Missing tag	A tag that is registered in the project is not registered in the host.
Different data type	The data type set for the tag registered in the project is different from the setting for the host tag.
Different array size	The setting for the number of elements for array tags registered in the project is different from the setting for the host tag.
Maximum number of tags is exceeded	A tag is registered in the project, but the maximum number of tags (20,000) is exceeded.
Communications error	An error occurred in communications with the host.

4. Check the differences, and then revise the settings for the project data or the tag.
5. To revise the settings of the host tag, click the **Recompare** Button to verify the tags again.
6. Click the **System Menu** Button to move to the System Menu. You can check the communications settings for the host and transfer memory card data.

Reference • Tags can be used when connection is made to a CJ2H-CPU□□-EIP, CJ2M-CPU3□, NJ□01-□□□□, NX□0□-□□□□, or NX1P2-□□□□ CPU Unit using EhterNet/IP.

- If ladder data is downloaded to the host, the tags will be verified once downloading has been completed when the host tags are monitored.

Examples for the Following Screen Data

Host	Host 1 and host 2
Screen 1	Using tags for host 1 and not host 2
Screen 2	Using tags for host 2

While screen 1 is displayed, tags will not be verified when ladder data is downloaded to host 2. Tags will be verified when you switch to screen 2.

- When ladder data is downloaded to the host, you can display a confirmation message before the system starts to verify tags. For information on the setting method, refer to *6-3-15 Setting the Tag Update Notification Message*.
 - The Tag Comparison Results List Screen can display up to 50 results.
 - If you are connected to an NJ□01-□□□□, NX□0□-□□□□, or NX1P2-□□□□ Controller, some time may be required to verify tags, depending on the task execution times. Allow leeway in the task period settings in comparison with the task execution times, or verify the tags when task execution is stopped.
-

Section 7

Maintenance and Troubleshooting

This section describes the maintenance and inspection methods for preventing errors occurring, and troubleshooting measures when errors occur in the PT.

7-1 Maintenance	7-2
7-1-1 Replacing the Battery	7-2
7-2 Inspection and Cleaning	7-4
7-3 Troubleshooting and Maintenance	7-6
7-4 Requesting a Replacement PT	7-14

7-1 Maintenance

Perform maintenance operations to maintain the PT in optimum condition.

 **WARNING**

Do not attempt to take the Unit apart and do not touch any internal parts while the power is being supplied. Doing either of these may result in electrical shock.



● Backing up Project Data

Always back up project data and store it in a safe place when the PT malfunctions and needs to be sent out for repair, or when replacing the Unit.

● Spare Units

Prepare a spare PT to allow quick recovery of the system at such times as when the PT malfunctions, or the service life of the backlight has expired causing poor screen visibility.

● Backlight

The backlight must be replaced when the brightness of the display backlight dims and the display becomes difficult to see. The backlight cannot be replaced by the user.

Contact your nearest OMRON representative.

● Backlight Replacement Guidelines

Replace the backlight according to the following guidelines under normal conditions.

After 50,000 hours of use at room temperature and humidity, (or after approximately 40,000 hours if an NS8-V1 PT is used.)

LEDs are used in the backlights of the following PTs: NS5-SQ1/-TQ1 PTs with lot number 15Z0 or later, NS8 PTs with lot number 28X1 or later, NS10 PTs with lot number 11Y1 or later, NS12 PTs with lot number 14Z1 or later, and NS15 PTs with lot number 31114 or later. Operation at high temperatures will reduce the life of the backlight. If the backlight become darker, making it difficult to see the screen, replace the backlight. The NS5-SQ1/-TQ1, NS8, NS10, NS12, NS15, and NS5-MQ PTs with lot numbers that are earlier than the ones given above use a CCFL (cold cathode fluorescent light) as the backlight. The life of the backlight is affected by environmental conditions, particularly by cold environments. If the backlight become darker, making it difficult to see the screen, replace the backlight.

7-1-1 Replacing the Battery

Use a lithium battery to back up data other than screen data, such as calendar, clock, and log data.

The battery service life is approximately five years at 25°C. The service life will be shortened if the battery is used at higher temperatures. Replace the battery periodically, according to the operating environment.

Keep a spare battery available, so that the battery can be replaced immediately when required.

- **Battery Models**

CJ1W-BAT01

- **Replacement Guidelines**

The guidelines for replacing the battery are as follows:

- Replace when five years have lapsed since a new battery was installed in the Unit.
- Replace within five days after the RUN indicator lights orange.

**Precautions
for Safe Use**

- Never use batteries that have been subjected to a severe shock, such as being dropped on the ground. Batteries subjected to shock may leak.
 - When mounting the battery, be sure to use the correct battery and mount it correctly.
-

- **Replacement Method**

Perform the following procedure within five minutes to replace the battery.

The shape of the battery cover and the direction for installing the connector depend on the PT model.

1. After power to the PT has been turned ON and at least five minutes have lapsed, turn OFF the power.
2. Open the battery cover on the rear panel of the PT.
3. Remove the battery that is secured inside the PT, grasp the cable, and pull the connector out vertically to remove it.

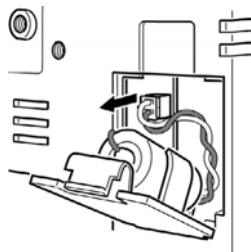

4. Connect the new battery connector, and insert the battery into the battery holder in the battery cover.

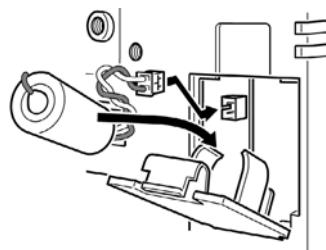

5. Close the battery cover, being careful not to squash the battery cable.

7-2 Inspection and Cleaning

Clean and inspect the PT periodically to maintain it in optimum condition for use.

● Cleaning Methods

The screen visibility will be impaired if the display becomes dirty. Clean the display periodically using the following methods:

- For daily cleaning, wipe with a soft, dry cloth. Attempting to remove heavy dirt with the cloth may scratch the front panel sheet. Use a damp cloth and wipe the surface again to remove dirt.
- If dirt cannot be removed using a dry cloth, dampen the cloth sufficiently with a neutral cleaning agent solution (approximately 2%), squeeze the cloth out, and then wipe the surface.
- Materials such as rubber, vinyl, or tape that are attached to the Unit will leave stains if left for a long time. If such material is attached to the Unit, remove when cleaning.

**Precautions
for Correct Use**

Never use benzene, thinner, or other volatile solvents, or chemical cloths to clean the PT.

● Inspection Methods

Inspect the PT once every six to twelve months. Shorten the interval between inspections when using the PT in extreme conditions, such as under high temperatures, high humidity, or environments subject to large quantities of dust.

• Inspection Items

Inspect the PT for the following items to check whether the PT is operating within the specified criteria. If the PT is outside the criteria, use measures such as improving the operating environment to conform to the standards, or tightening screws.

Inspection items	Inspection details	Criteria	Inspection means
Power supply	Power terminal voltage fluctuation	Allowable voltage range (24 VDC \pm 15%)	Tester
Ambient environment	Ambient temperature (temperature in control panel)	0 to 50°C (Refer to <i>Appendix 1.</i>)	Thermometer
	Ambient humidity (temperature in control panel)	35% to 85% (Refer to <i>Appendix 1.</i>)	Temperature meter
	Presence of dust	No dust accumulated.	Visual inspection
	Presence of oil	No oil between front panel sheet and molding.	Visual inspection
Mounting conditions	Looseness of fixed mounting bracket	Specified torque.	Phillips screwdriver
	Connection status of Connecting Cable Connectors	Fully inserted, locked, and with No looseness.	Phillips screwdriver
	Looseness of external wiring screws	No looseness.	Phillips screwdriver
	Status of external connecting cables	No breaks or other damage	Visual inspection, tester
Parts with limited service life	Backlight brightness	Sufficient brightness. Backlight life (at room temperature of 25°C) is 50,000 hours, as a guideline.	Visual inspection
	Battery	5 years (at room temperature of 25°C).	Replace every 5 years
Touch panel input position accuracy (NS15 only)	Shifted input positions on the touch panel	Calibrate the touch panel if the input positions have shifted.	Touch panel operation

Precautions for Safe Use

- Do not disassemble, repair, or modify the PT.
- Follow all local government regulations, where applicable, when disposing of the Unit and used batteries.

7-3 Troubleshooting and Maintenance

When an error occurs while operating the PT, search for the symptom in the following table and take measures according to those provided.

Errors during Data Transfer

Symptoms at PT	Cause	Possible countermeasure
Serial transfer not possible between CX-Designer and PT.	The CX-Designer is not connected to the PT.	Check the wiring conditions of the connecting cable. (Refer to 3-3 <i>Connecting the CX-Designer</i> .)
	The <i>Expansion Interface</i> for serial port B is set to the expansion interface (NS5 only).	Set the Expansion Interface to <i>Disable</i> on the Comm Tab Page from the NS5 System Menu.
	The serial port used for connection with the CX-Designer is set to Allen-Bradley DF1.	Data cannot be transferred using a serial port set to Allen-Bradley DF1. Use another serial port. Alternatively, change the serial port setting to <i>Disable</i> in the Comm. Tab of the System Menu. Click the Write Button, and transfer the data again after resetting the NS-series PT.
Personal computer cannot detect PT when connected via USB.	The installed PT system is using system program lower than Ver. 6.2.	Install system program Ver. 6.2 or higher in the PT.
	The PT has a lot number earlier than that indicated in 3-3-2 <i>Connecting via USB</i> .	Use a PT from the lot number (or later) indicated in 3-3-2 <i>Connecting via USB</i> .
	The USB cable is longer than 2 m.	To use a cable longer than 2 m, connect a USB Hub between the PT and personal computer as shown in <i>Connection Methods</i> under in 3-3-2 <i>Connecting via USB</i> .
	A malfunction has occurred due to external noise.	Configure the USB Hub and wire the USB cables taking measures to prevent noise.
	A PictBridge-compatible printer is connected to the USB slave connector.	Connect the personal computer to the USB slave connector.
Timeout occurs during screen transfer using USB.	The USB cable is longer than 2 m.	To use a cable longer than 2 m, connect a USB Hub between the PT and personal computer as shown in <i>Connection Methods</i> under in 3-3-2 <i>Connecting via USB</i> .
	A malfunction has occurred due to external noise.	Configure the USB Hub and wire the USB cables taking measures to prevent noise.

Errors during PT Startup

Symptoms at PT	Cause	Possible countermeasure
Indicators do not light.	Power is not being supplied to the PT.	Check the connection points and supply power to the PT correctly. (Refer to 3-1 <i>Installing the PT</i> .)
	The fuse is broken.	The PT needs repair. Contact your nearest OMRON representative.

Symptoms at PT	Cause	Possible countermeasure
Indicators do not light.	The system program is corrupted (fatal error).	The PT may be faulty. Contact your nearest OMRON representative.
The indicator is lit orange and the screen is blank.	The system program is corrupted (fatal error).	The PT may be faulty. Contact your nearest OMRON representative.
	The Memory Card cannot be recognized.	<ul style="list-style-type: none"> • Use a Memory Card specified by OMRON. (Refer to 3-6 <i>Using Memory Cards</i>.) • If you can confirm that the NS-series PT is operating normally after the Memory Card has been removed from the PT, there may be a failure in the Memory Card. Replace the Memory Card before using the PT.
The indicator is lit green and the screen is blank.	The system program is corrupted (non-fatal error). The combination of NS-series PT hardware and system program version is incorrect.	Recovery/update the system program. (Refer to 3-6 <i>Using Memory Cards</i> .) Contact your nearest OMRON representative if the same problem occurs after recovering/updating the system program.
	<p>In the following cases, project data was downloaded without clearing the log data saved in the NS.</p> <ul style="list-style-type: none"> • A project was downloaded to the NS-series PT in which settings related to history, such as alarm/event or data log settings, have been changed. • An attempt was made to download a project that was different from the project saved in the NS. 	Download the project data again. When downloading the project data again, be sure to clear the log data saved in the NS.
The indicator is flashing green and the buzzer repeatedly turns ON and OFF.	The backlight has malfunctioned.	The backlight must be replaced. Contact your nearest OMRON representative.
The screen is blank and the indicator is flashing green.	Automatic upload/download has ended normally.	This is not an error. Turn OFF all the DIP switch pins and turn ON the power to the PT again.

7-3 Troubleshooting and Maintenance

Symptoms at PT	Cause	Possible countermeasure
The screen is blank and the indicator is flashing red.	Automatic upload/download has ended abnormally.	The system program may be corrupted. Reinstall the system program. (Refer to 3-6 <i>Using Memory Cards</i> .) If the same problem occurs after reinstalling the system program, the PT may be faulty. Contact your nearest OMRON representative. An attempt may have been made to transfer screens that are larger than the memory of the PT. Check the screen data at the transfer destination.
The indicator is lit red and the screen is blank.	The PT is faulty, or the system program is corrupted.	Reinstall the system program. (Refer to 3-6 <i>Using Memory Cards</i> .) If the same problem occurs after reinstalling the system program, the PT may be faulty. Contact your nearest OMRON representative.

Errors during PT Powerup

Message	Cause	Possible countermeasure
FATAL ERROR No. 01: Touch Panel is not connected: Please contact your OMRON service center.	Touch panel error.	Contact your nearest OMRON representative.
FATAL ERROR No.01: Touch Panel Initialization Error: Please contact your OMRON service center		
FATAL ERROR No. 02: SRAM Initialization Error: Please contact your OMRON service center.	Hardware error in log SRAM.	Contact your nearest OMRON representative.
FATAL ERROR No. 03: MAC Address Error: Please contact your OMRON service center.	Incorrect MAC address.	
FATAL ERROR No. 04: PT Model type Identify Error: Please contact your OMRON service center.	Built-in model code cannot be read.	
ERROR No. 10: File System Error: Please recover the system program.	File system is corrupted. (A hardware fault occurred or power was interrupted during writing.)	Reinstall the system program by inserting the Memory Card containing the recovery program in the PT and resetting the PT or turning the power supply OFF and ON again. (Refer to 3-6 <i>Using Memory Cards</i> in the <i>Setup Manual</i> .) When the PT contains a read-only file, do a clean installation. After the clean installation, verify that the project data does not contain any read-only files and transfer the project data. If the same problem occurs after reinstalling the system program, contact your nearest OMRON representative.
ERROR No. 10: Fail in loading files or executing program: Please recover the system program.	File reading or program execution failed. A read-only file is being transferred to the PT.	
ERROR No. 10: Fail in loading files: Please recover the system program.	File reading failed.	

Message	Cause	Possible countermeasure
ERROR No. 11: Fail in loading files: Please reinstall the system program.	File reading failed.	Execute automatic download of the system program. If the same problem occurs after downloading, insert the Memory Card containing the recovery program in the PT and reset the PT or turn the power supply OFF and ON again. (Refer to 3-6 <i>Using Memory Cards</i> in the <i>Setup Manual</i> .) If the same problem occurs after reinstalling the system program, contact your nearest OMRON representative.
ERROR No. 11: Device check program error: Please reinstall the system program.	Hardware check program is corrupted.	
ERROR No. 11: SRAM check program error: Please reinstall the system program.	Log SRAM check program is corrupted.	
ERROR No. 11: IP Address Setting Error: Please reinstall the system program.	IP address setting program is corrupted.	
ERROR No. 11: Device check program error: Touch the screen to continue.	At startup with DIP switch 6 set to ON, the hardware check program is corrupted.	The Memory Card transfer program started up after this can be used. If operation is not restored after continuing with the Memory Card transfer program, insert the Memory Card containing the recovery program in the PT and reset the PT or turn the power supply OFF and ON again. (Refer to 3-6 <i>Using Memory Cards</i> in the <i>Setup Manual</i> .) If the same problem occurs after reinstalling the system program, contact your nearest OMRON representative.
ERROR No. 12: Fail in loading fonts: Please reinstall the system program.	Reading of font files when operation performed with DIP switch 6 set to ON failed.	Download the system program by automatic download that does not use DIP switch 6. If operation is not restored after downloading, insert the Memory Card containing the recovery system program in BANK 1 in the PT. (Refer to 3-6 <i>Using Memory Cards</i> in the <i>Setup Manual</i> .) If the same problem occurs after reinstalling the system program, contact your nearest OMRON representative.
ERROR No. 12: Installed system program is not applicable for this hardware: Please reinstall the system program.	The installed system program does not match the hardware.	
ERROR No.13: Memory Card Error: Memory card or some files in a memory card may be corrupted. Safely change the memory card, and reset the PT or turn the power supply OFF and ON again.	Memory card is corrupted, or using unsupported memory card.	Safely remove the memory card, and change it. (Refer to 3-6 <i>Using Memory Cards</i> in the <i>Setup Manual</i> .) If the same problem occurs after changing the memory card, contact your nearest OMRON representative.
WARNING No. 20: Date and Time are not set: Touch the screen to continue.	Date set outside the PT's allowable range of 2000 to 2049.	Touch the touch panel to continue booting. Then set the correct date in the System Menu.
WARNING No. 21: SRAM previously broken... Initialization Complete: Touch the screen to continue.	SRAM contents could not be held because the battery was not connected or there was insufficient capacity. For this reason, SRAM was initialized.	Touch the touch panel to continue booting. Replace the battery the next time power is turned OFF.

7-3 Troubleshooting and Maintenance

Message	Cause	Possible countermeasure
WARNING No. 22: Memory Card Error: Some files in a memory card may be corrupted. Safely remove the memory card, and check whether files are not corrupted on a computer. You can continue to startup the PT by touching on the screen, however, it may NOT operate correctly when accessing to the memory card. (The same message will also be displayed in Japanese. This is not a fault.)	The two following causes are possible: The previous time the PT was used, power was turned OFF while accessing the Memory Card. Memory Card access safety information could not be held because the battery was connected or there was insufficient capacity.	Touch the touch panel to continue booting. When the Memory Card is accessed, however, the PT may not operate normally.
WARNING No. 23: Screen data file(s) is not correct: Touch the screen to continue and transfer screen data again.	The PT screen data is corrupted. (The cable was disconnected or the power was turned OFF during screen data transfer).	Touch the PT's touch panel, and after <i>connecting</i> is displayed at the bottom right of the screen, or after the message "No project data is registered. Press OK button and download project data." is displayed, reattempt screen transfer.
WARNING No. 24: The recovery program in the inserted Memory Card is not supported by the PT. Update the recovery program, referring to NS Series Setup Manual. To continue starting the PT without executing the program, touch the screen.	The recovery program cannot be started because the recovery program installer in the Memory Card that is inserted in the PT is not supported by the current hardware version of the PT.	Touch the screen to start the system that is currently installed in the PT (i.e., not the recovery program). To start the recovery program that is in the Memory Card, you must update the recovery program that is stored in the Memory Card. To update the program, install the CX-Designer in a personal computer and then select Programs - OMRON - CX-One – CX-Designer – How to recover or update the system program from the Window's Start Menu.

Errors while Connecting to the Host

Symptoms at PT	Cause	Possible countermeasure
PT cannot communicate with the host. (An error message is displayed or <i>connecting</i> is displayed at the bottom right of the screen.)	The settings for Ethernet connection, such as node number, network number, and IP address, are not set correctly.	Set the settings correctly, referring to <i>Section 5 Connecting to Host via Ethernet or Controller Link</i> .
	The protocol settings for the host and the settings at the PT do not match.	Set the communications settings using the CX-Designer.
	The PT is not connected to the host properly.	Check that the type, length, and wiring of the connecting cables meet the specifications. (Refer to <i>Section 4 Connecting the Host to Serial Port</i> .)
	For 1:N NT Link connections, two or more Units have the same unit number.	Reset so that each Unit has a unique unit number. (Refer to <i>6-6 Communications Settings</i> .)

Symptoms at PT	Cause	Possible countermeasure
PT cannot communicate with the host. (An error message is displayed or <i>connecting</i> is displayed at the bottom right of the screen.)	With the NS5, the <i>Expansion Interface</i> for serial port B is set to the expansion interface when the connection is to serial port B.	Set the Expansion Interface to <i>Disable</i> on the Comm Tab Page from the NS5 System Menu.
	Initializing system memory at startup has been disabled, and the NS-series PT was started with a non-existing screen number (0 to 3,999) set in the allocation address of \$SW0 or with a special screen number set, such as 4002, that displays the system menu.	Correctly set the screen number for display in the allocation address of \$SW0.

Errors during PT Operation

Symptoms at PT	Cause	Possible countermeasure
RUN indicator does not light.	Power is not being supplied to the PT.	Check the connection points and supply power to the PT correctly. (Refer to 3-1 <i>Installing the PT</i> .)
	The fuse is broken.	Contact your nearest OMRON representative.
	The RUN indicator is too dark.	Increase the brightness of the backlight on the PT Setting Tab Page of the System Menu.
The screen is blank.	The PT is in system startup waiting status.	This is not an error. Information will be displayed when the waiting time has lapsed.
	The screen saver function is operating.	This is not an error. Touch the screen, or operate the system memory for switching the screen from the host to switch the screen as follows: <ul style="list-style-type: none"> Set the screen number in \$SW0. Set the pop-up screen number in \$SW1, 4 and 7. (Refer to 2-4 <i>System Memory</i> in the <i>PT Programming Manual</i> for details on the system memory.)
	The backlight is OFF.	Turn ON the backlight by setting system memory bits \$SB6 to 8 for adjusting backlight brightness to ON. (Refer to 2-4 <i>System Memory</i> in the <i>PT Programming Manual</i> for details on the system memory.)
	The backlight has malfunctioned.	The backlight must be replaced. Contact your nearest OMRON representative.
	The backlight is too dark.	Increase the brightness of the backlight on the PT Setting Tab Page of the System Menu.
The display update is slow.	Screen switching, opening and closing pop-up screens, and switching frames are being performed frequently.	If screens are opened and closed frequently, the display update may take some time and communications may be delayed. Adjust the interval between screen switches so that the system is not overloaded.
	The message communications interval is too long.	In the CX-Designer, select PT - Communication Setting , click the Comm-All Tab, and set a shorter communications interval. (For details, refer to <i>System Settings and Project Properties</i> in the CX-Designer's Online Help.)

7-3 Troubleshooting and Maintenance

Symptoms at PT	Cause	Possible countermeasure
Screens are slow to change.	Communications are not possible with the host.	If a communications error is displayed, refer to 5-2-7 <i>Communication Errors and Countermeasures</i> in the <i>NS Series Programmable Terminals PROGRAMMING MANUAL</i> (Cat. No. V073). Communications errors will not be displayed if automatic recovery is set for communications. If automatic recovery is set, check if communications with the host are possible using the communications test on the System Menu. If more than one host is registered, test communications with all of the hosts.
The touch panel does not respond.	PT has malfunctioned due to external noise.	Reset the PT, and wire it according to noise prevention measures.
	The touch panel is damaged.	Test the touch panel using the hardware check in the System Menu. If an error has occurred, contact your nearest OMRON representative.
The display is dark.	The brightness setting is too low.	Increase the backlight brightness in the PT Tab Page of the System Menu.
	The backlight is faulty or its service life has expired.	The backlight must be replaced. Contact your nearest OMRON representative.
Cannot enter the device monitor function.	The communications settings are incorrect.	When using the device monitor, set the communications mode as follows: <ul style="list-style-type: none"> • C-series PLCs: 1:1 NT Link or 1:N NT Links • CS1-series PLCs: 1:N NT Links (normal, high speed) The device monitor function is not supported for Ethernet or Controller Link.
	The PLC does not support the device monitor function.	The PLCs that support the device monitor function are restricted. Check the PLC model being used. (Refer to 6-8-4 <i>Device Monitor</i> .)

Errors during Object Operation

Symptoms at PT	Cause	Possible countermeasure
The numerical and character string update is slow.	Communications are unstable due to external noise.	Perform noise countermeasures such as separating communications cables from power lines.
	There are too many Numeral Display & Input objects and String Display & Input objects in the display.	Reduce the number of Numeral Display & Input and String Display & Input objects in the screen where update is slow.
	For RS-422A communications, the branch is incorrect or the terminating resistance is not set properly.	Wire correctly, referring to <i>Appendix 3 Using NS-AL002 Converters</i> .

Symptoms at PT	Cause	Possible countermeasure
The numerical and character string update is slow.	The host is processing a large volume of data and the cycle time is long.	Shorten the host cycle time.
	The message communications interval is too long.	In the CX-Designer, select PT - Communication Setting , click the Comm-All Tab, and set a shorter communications interval. (For details, refer to <i>System Settings and Project Properties</i> in the CX-Designer's Online Help.)
Some objects in the screen configuration are not displayed.	A communications error has occurred.	Check the communications settings again.
	The control flags set in the object include Hide Display Flags.	Display the control flags for the objects set to be not displayed, as follows: Display the Expansion Tab from the functional object property setting using the CX-Designer. Select <i>Display</i> from <i>Display/Hide</i> in the Control Flags Tab Page. Turn ON the indirect address of the control flag set for the object.
The Log Flag display does not match the actual log timing.	The communications address set for the event of log timing is turning ON and OFF at high speed.	Set the ON/OFF cycle of the communications address for events to a longer time.
Cannot input numerical values.	The numerical value input upper and lower limit check function is running.	Display the Expansion Tab from the functional object property setting using the CX-Designer. Check the set values in the Input Upper and Lower Limits Tab Page and correct if necessary.
Cannot input for some functional objects.	The control flags set in the objects include Input Prohibit Flags.	Display the Expansion Tab from the functional object property settings using the CX-Designer. Select <i>Enable</i> for <i>Input</i> in the Control Flag Tab Page. Turn ON the indirect address of the control flag set for the object.
	A password has been set.	Input the password in the password input dialog box that is displayed.
Cannot input to any functional object.	PT is set to input prohibit mode.	Set system memory bit \$SB19 to OFF.
		Touch the screen and input the password to cancel disabling inputs.
		Turn ON or OFF the touch switch lock control flag to enable input. (Whether ON or OFF enables input depends on the settings.)
Cannot move to System Menu.	Moving to System Menu is prohibited.	Set system memory bit \$SB3 to OFF.
The list selection and bitmap object are blank.	There is no reference file.	Use the CX-Designer to check whether the folder storing project data contains a reference file, and resend the screen data to the PT.
	The number of rows specified in the first row of the list selection is above the maximum.	Set the number of rows to less than the maximum.

7-4 Requesting a Replacement PT

Always observe the following precautions when faults are detected during inspection and the PT is to be replaced.

- Create a backup of the PT project data.
Project data may be deleted when the PT is repaired by OMRON.
- Always turn OFF the power before replacing the PT.
- After replacing the PT, check to confirm that the new PT has no faults.
- When returning a faulty PT for repair, include a document with the Unit that provides as many details on the fault as possible, and send to your OMRON representative.

Appendices

Appendix 1	Specifications.....	A-3
A-1-1	General Specifications.....	A-3
A-1-2	Characteristics	A-5
A-1-3	Communications Specifications	A-8
Appendix 2	Dimensions	A-12
Appendix 3	Using NS-AL002 Converters	A-21
A-3-1	Dimensions.....	A-21
A-3-2	Mounting and Removing.....	A-22
A-3-3	Specifications	A-22
A-3-4	DIP Switch Settings.....	A-23
A-3-5	Pin Arrangement	A-24
A-3-6	Handling the Shield on RS-422A/485 Cables.....	A-25
A-3-7	Connection Example	A-28
Appendix 4	Using NT-AL001 Converters	A-29
A-4-1	Dimensions.....	A-29
A-4-2	Methods for Mounting and Removal	A-29
A-4-3	Specifications	A-31
A-4-4	DIP Switch Settings.....	A-32
A-4-5	Pin Arrangement	A-33
A-4-6	Block Diagram	A-34
Appendix 5	Preparing Connecting Cables.....	A-35
A-5-1	Cable Preparation	A-35
A-5-2	Soldering	A-36
A-5-3	Hood Assembly	A-36
A-5-4	Preparing Connecting Cables for Host Connection.....	A-37
Appendix 6	Preparing Cables for Computer Connection	A-41
A-6-1	Connecting Cable Assembly	A-41
Appendix 7	Preparing Connecting Cables for Bar Code Readers	A-43
Appendix 8	Standard Models	A-44
Appendix 9	List of Optional Products.....	A-61
A-9-1	Anti-reflection Sheets: NS15-KBA04, NS12-KBA04, NS7-KBA04, NT30-KBA04.....	A-61
A-9-2	Protective Covers: NS15-KBA05N, NS12-KBA05(N), NS7-KBA05(N), NT31C-KBA05(N).....	A-62

A-9-3 NT30-KBA01 Chemical-resistant Cover	A-63
A-9-4 Replacement Battery: CJ1W-BAT01	A-63
A-9-5 Recommended Memory Cards	A-64
A-9-6 NS-CLK21 Controller Link Interface Unit	A-64
A-9-7 NS-CA001/CA002 Video Input Unit	A-64
A-9-8 Attachments: NS12-ATT01(B)/NS12-ATT02/NS8-ATT01/ NS8-ATT02	A-64
A-9-9 NS-USBEXT-1M USB Relay Cable	A-65
Appendix 10 System Memory List	A-66
Appendix 11 Differences between "-V1"/"-V2" Models and Other Models	A-69
Appendix 12 NS5 System Menu	A-71

Appendix 1 Specifications

A-1-1 General Specifications

Item	Specifications				
	NS15-TX01□-V2	NS12-TS0□-V1 NS12-TS0□-V2	NS10-TV0□-V1 NS10-TV0□-V2	NS8-TV□□-V1 NS8-TV0□-V2	NS5-SQ0□-V1 NS5-SQ□□-V2 NS5-TQ□□-V2 NS5-MQ□□-V2
Rated power supply voltage	24 VDC				
Allowable voltage range	20.4 to 27.6 VDC (24 VDC ±15%)				
Allowable input power interruption time	No restriction.				
Power consumption	45 W max.	25 W max		15 W max.	
Ambient operating temperature	0 to 50°C (See notes 1, 2, and 3.)				
Storage temperature	-20 to 60°C (See note 2.)				
Ambient operating humidity	35% to 85% (0 to 40°C) with no condensation 35% to 60% (40 to 50°C) with no condensation				
Operating environment	No corrosive gases.				
Noise immunity	Conforms to IEC61000-4-4, 2 KV (power lines)				
Vibration resistance (during operation)	5 to 8.4 Hz with 3.5 mm single amplitude and 8.4 to 150 Hz with 9.8 m/s ² acceleration 10 times in each of X, Y, and Z directions	10 to 57 Hz with 0.075 mm amplitude and 57 to 150 Hz with 9.8 m/s ² acceleration for 30 min in each of X, Y, and Z directions			
Shock resistance (during operation)	147 m/s ² 3 times in each of X, Y, and Z directions.				
Dimensions	405 × 304 × 75.8 mm (W × H × D)	315 × 241 × 48.5 mm (W × H × D)		232 × 177 × 48.5 mm (W × H × D)	195 × 142 × 54 mm (W × H × D)
Panel cutout dimensions	Width 383.5 ⁺¹ ₀ × Height 282.5 ⁺¹ ₀ mm Panel thickness: 1.6 to 4.8 mm	Width 302 ⁺¹ ₀ × Height 228 ⁺¹ ₀ mm Panel thickness: 1.6 to 4.8 mm	Width 302 ⁺¹ ₀ × Height 228 ⁺¹ ₀ mm Panel thickness: 1.6 to 4.8 mm	Width 220.5 ^{+0.5} ₀ × Height 165.5 ^{+0.5} ₀ mm Panel thickness: 1.6 to 4.8 mm	Width 184 ^{+0.5} ₀ × Height 131 ^{+0.5} ₀ mm Panel thickness: 1.6 to 4.8 mm
Weight	4.2 kg max.	2.5 kg max.		2.0 kg max.	1.0 kg max.
Enclosure rating	Front panel: IP65 oil-proof type (equivalent to NEMA4) (See note 4.)			Front-panel controls: IP65 oil-proof type	Front panel: IP65 oil-proof type (equivalent to NEMA4) (See note 4.)
Battery life	5 years (at 25°C) The SRAM and RTC will be backed up for 5 days after the battery runs low (indicator lights orange). The SRAM and RTC will be backed up by a super capacitor for 5 minutes after removing the old battery. (This assumes that the power is first turned ON for at least 5 minutes and then turned OFF.)				
International standards	EC Directives	UL 1604 Class 1 Division 2, EC Directives			

Note 1. The operating temperature is subject to the following restrictions, depending on the mounting angle and whether an Expansion Unit is installed or not.

- Without any Expansion Unit Installed
 - NS15-V2/NS12-V1/-V2, NS10-V1/-V2, NS8-V1/-V2
 - Mounting angle of 0° to less than 30° to the horizontal:
 - Operating temperature range of 0 to 45°C
 - Mounting angle of 30° to 90° or less to the horizontal:
 - Operating temperature range of 0 to 50°C
 - NS5-V1/-V2
 - Mounting angle of 0° to 90° or less to the horizontal:
 - Operating temperature range of 0 to 50°C
- With an Expansion Unit (Video Input Unit or Controller Link Unit) Installed
 - NS15-V2/NS12-V1/-V2, NS10-V1/-V2
 - Mounting angle of 0° to less than 30° to the horizontal:
 - Operating temperature range of 0 to 35°C
 - Mounting angle of 30° to 90° or less to the horizontal:
 - Operating temperature range of 0 to 50°C
 - NS8-V1/-V2
 - Mounting angle of 0° to less than 30° to the horizontal:
 - Operating temperature range of 0 to 35°C
 - Mounting angle of 30° to less than 90° to the horizontal:
 - Operating temperature range of 0 to 45°C
 - Mounting angle of 90° to the horizontal:
 - Operating temperature range of 0 to 50°C

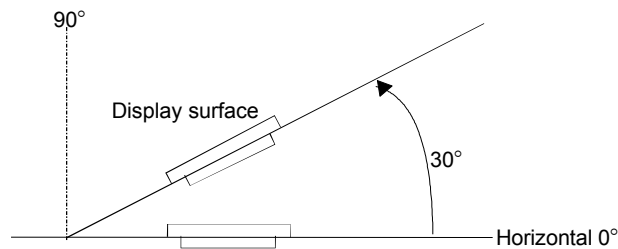

2. Operate the PT within the temperature and humidity ranges shown in the following diagram.

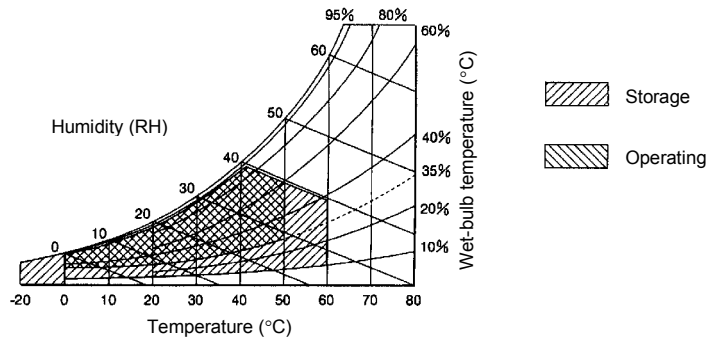

3. When a STN LCD display device is used, the display quality will decline (e.g., the contrast ratio will be reduced) if the temperature exceeds 40°C. Also, when the temperature drops, the response speed is lowered due to characteristics of liquid crystals. This applies to the following models. Refer to *NS-series PT Lot Numbers* on page A-8 for information on lot numbers.

Display device	PT model
Color STN LCD	NS5-SQ0□-V1
	NS5-SQ□□-V2 with lot number earlier than 2110
Monochrome STN LCD	NS5-MQ□□-V2

4. May not be applicable in locations with long-term exposure to oil.

A-1-2 Characteristics

● Display Specifications

Item	Specifications					
	NS15-TX01□-V2	NS12-TS0□-V1 NS12-TS0□-V2	NS10-TV0□-V1 NS10-TV0□-V2	NS8-TV□□-V1	NS8-TV0□-V2	
Display panel (See note 5.)	Display device	High-definition TFT color LCD				
	Number of dots	1024 dot horizontal × 768 dot vertical	800 dot horizontal × 600 dot vertical	640 dot horizontal × 480 dot vertical		
	Display color	256 colors (32,768 colors for BMP/JPEG images, NS5: 4,096 colors for BMP/JPEG images)				
	Display area	Width 304.1 mm × height 228.1 mm (15.0 inches)	Width 246.0 mm × height 184.5 mm (12.1 inches)	Width 215.2 mm × height 162.4 mm (10.4 inches)	Width 162.2 mm × height 121.7 mm (8.0 inches)	Width 170.9 mm × height 128.2 mm (8.4 inches)
View angle	Left 80°, Right 80°, Top 70°, Bottom 60°	-V1: Left 60°, Right 60°, Top 45°, Bottom 55°, -V2: Left 80°, Right 80°, Top 80°, Bottom 80°	-V1: Left 60°, Right 60°, Top 35°, Bottom 65°, -V2: Left 70°, Right 70°, Top 65°, Bottom 65°	Left 60°, Right 60°, Top 50°, Bottom 60°	Left 80°, Right 80°, Top 80°, Bottom 60°	
Backlight (See note 4.)	Life expectancy	50,000 hours min. (See note 1.)			40,000 hours min. (See note 1.)	50,000 hours min. (See note 1.)
	Brightness adjustment	There are 3 levels or 32 levels of adjustment that you can make by operating the touch panel. (See note 9.)				
	Backlight error detection	Error is detected automatically, and the RUN indicator flashes green as notification. (See note 3.)			No detection function.	Error is detected automatically, and the RUN indicator flashes green as notification. (See note 3.)
Front panel indicators	RUN	Lit green: PT is operating normally. Flashing green: The Memory Card transfer has ended normally or a backlight error was detected immediately after power was turned ON. (Backlight errors are not detected for the NS8-V1.) Lit orange: Immediately after power turns ON, indicates file system check in progress, battery low, or disconnected and operating normally. Flashing orange: Memory Card transfer in progress. Flashing red: Memory Card transfer has ended abnormally.				
Rear panel indicators	MCPWR	Lit green: Memory Card power ON. Green not lit: Memory Card power OFF.	None			

Item		Specifications			
		NS5-SQ□□-V1	NS5-SQ□□-V2 (See note 6.)	NS5-TQ□□-V2	NS5-MQ□□-V2
Display panel (See note 5.)	Display device	STN color LCD	TFT color LCD	High-luminance TFT color LCD (See note 7.)	Monochrome STN LCD
	Number of dots	320 dot horizontal × 240 dot vertical			
	Display color	256 colors (4,096 colors for BMP/JPEG images)	256 colors (32,768 colors for BMP/JPEG images)		Monochrome/16 gray-scale levels
	Display area	Width 117.2 mm × Height 88.4 mm (5.7 inches)			
	View angle	Left 50°, Right 50°, Top 30°, Bottom 50°	Left 80°, Right 80°, Top 80°, Bottom 60°	Left 45°, Right 45°, Top 20°, Bottom 40°	
Backlight (See note 4.)	Life expectancy	50,000 hours min. (See note 1.)	75,000 hours min. (See note 1.)		50,000 hours min. (See note 1.)
	Brightness adjustment	The brightness can be adjusted to any of 3 levels by operating the touch panel. (See note 2.)	The brightness can be adjusted to any of 3 levels or any of 32 levels by operating the touch panel. (See note 8.)		The brightness can be adjusted to any of 3 levels by operating the touch panel. (See note 2.)
	Backlight error detection	No detection function.	Error is detected automatically, and the RUN indicator flashes green as notification. (See note 3.)		
Front panel indicators	RUN	Lit green: PT is operating normally. Flashing green: The Memory Card transfer has ended normally or a backlight error was detected immediately after power was turned ON. (Backlight errors are not detected for the NS5-V1.) Lit orange: Immediately after power turns ON, indicates file system check in progress, battery low, or disconnected and operating normally. Flashing orange: Memory Card transfer in progress.			

- Note 1. This is the estimated time before brightness is reduced by half at room temperature and humidity. It is not a guaranteed value. (It is based on the middle brightness setting using the NS8.)
 The life expectancy will be drastically shortened if PT is used at low temperatures. For example, using the PT at temperatures of 0°C will reduce the life expectancy to approximately 10,000 hours (reference value).
- The brightness cannot be adjusted much.
 - This function does not detect service life expectancy.
 - It detects when the backlight is not lit due to a disconnection or other errors. Backlight error detection indicates that all backlights are OFF.
 - Contact your nearest OMRON representative to replace the backlight.
 - There may be some defective pixels in the display. This is not a fault as long as the numbers of defective light and dark pixels fall within the following standard ranges.

Model	Standard range
NS15-TX01□-V2 NS12-TS□□-V1/-V2 NS10-TV□□-V1/-V2 NS8-TV□□-V1/-V2	Number of light and dark pixels: 10 or less. (Must not be 3 consecutive.)
NS5-SQ□□-V1/-V2 NS5-MQ□□-V2 NS5-TQ□□-V2	Number of light and dark pixels: 4 or fewer defects the size of $0.2 < (\text{minor axis} + \text{major axis}) / 2 \leq 0.55$ mm (within 1 per 20-mm square)

- Specifications are as follows for NS5-SQ□□-V2 PTs with lot number 2110 (manufactured January 21, 2010) or earlier.

Item	Specification
Display device	STN color LCD
Display colors	256 colors (4,096 colors for BMP/JPEG images)
View angle	Left 50°, Right 50°, Top 45°, Bottom 50°

Refer to *NS-series PT Lot Numbers* on page A-8 for information on lot numbers.

The NS5-TQ PTs (high-luminance TFT LCDs) are approx. 70 cd/m² brighter than the NS5-SQ PTs (TFT LCDs).

7. Lot number 14Z0 or earlier can be adjusted to only one of three levels.
8. NS8 PTs with lot number 27X1 or earlier can be adjusted to only three levels. NS10 PTs with lot number 10Y1 or earlier can be adjusted to only three levels. NS12 PTs with lot number 13Z1 or earlier can be adjusted to only three levels. NS15 PTs with lot number 30114 or earlier can be adjusted to only three levels.

● Operating Specifications

Item	Specifications				
	NS15-TX01□-V2	NS12-TS0□-V1/ NS12-TS0□-V2	NS10-TV0□-V1/ NS10-TV0□-V2	NS8-TV□□-V1/ NS8-TV□□-V2	NS5-SQ0□-V1 NS5-SQ□□-V2 NS5-TQ□□-V2 NS5-MQ□□-V2
Touch panel	Method: Resistive membrane				
	Vertical and horizontal resolution: 1024 Three function keys (Analog type)	Number of switches: 1900 (50 horizontal × 38 vertical) 16 × 16 dots for each switch. (Matrix type)	Number of switches: 1200 (40 horizontal × 30 vertical) 16 × 16 dots for each switch. (Matrix type)	Number of switches: 768 (32 horizontal × 24 vertical) 20 × 20 dots for each switch. (Matrix type)	Number of switches: 300 (20 horizontal × 15 vertical) 16 × 16 dots for each switch. (Matrix type)
	Input: Pressure-sensitive				
	Service life: 1,000,000 touch operations.				

● Data Capacity Specifications

Item	NS15-TX01□-V2 NS12-TS0□-V2 NS10-TV0□-V2 NS8-TV0□-V2	NS12-TS0□-V1 NS10-TV0□-V1	NS8-TV□□-V1	NS5-SQ0□-V1	NS5-SQ0□-V2 NS5-TQ0□-V2 NS5-MQ0□-V2
Standard screen data capacity	60 MB	20 MB	NS8-TV0□-V1: 6 MB NS8-TV1□-V1: 20 MB	6 MB	20 MB

● External Interface Specifications

Item	Specifications			
	NS15-TX01□-V2	NS12-TS0□-V1/V2 NS10-TV0□-V1/V2 NS8-TV□□-V1/V2	NS5-SQ0□-V1/V2 NS5-TQ0□-V2 NS5-MQ0□-V2	NS5-SQ1□-V2 NS5-TQ1□-V2 NS5-MQ1□-V2
USB HOST	1 port (for connecting printers)		None	
USB Slave	1 port (screen data transfer, connection to computer, connection to printer) (NS-V2 only)		1 port (screen data transfer, connection to computer)	1 port (screen data transfer, connection to computer, connection to printer)
Memory card interface	1 ATA-Compact Flash interface slot. Used to transfer and store screen data and to store history data.			
Expansion interface (See note 1.)	For Expansion Interface Units Used to install a Controller Link Interface Unit or Video Input Unit.		For Expansion Interface Units Used to install Expansion Units specially designed for the NS5. (From Lot No. 01218, this connector is not incorporated)	
Analog RGB output	1 port (connects to an LCD monitor)	---		
External brightness adjustment	Used to adjust brightness externally (See note 2.)	---		

Note 1. This interface is for NS-series PTs only. Units not specified in this manual cannot be installed.

2. This applies to lot numbers 30114 and earlier.

● **Programming Device (Software for Creating Screen Data)**

Item	Specifications
Name	CX-Designer
Model	NS-CXDC1-V□

● **NS-series PT Lot Numbers**

The four-digit lot number that is given on the back of an NS-series PT can be used to check the manufacturing date of PTs that were manufactured on May 31, 2012 or earlier.

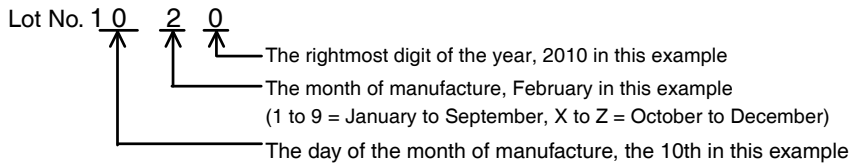

The five-digit lot number that is given on the back of an NS-series PT can be used to check the manufacturing date of PTs that were manufactured on June 1, 2012 or later.

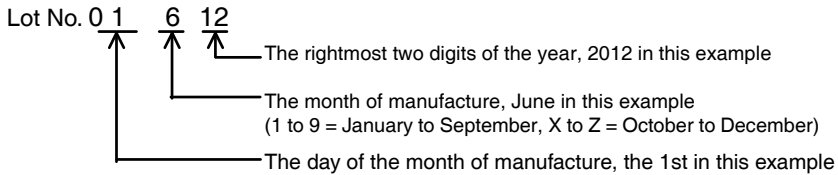

A-1-3 Communications Specifications

● **Serial Communications**

Item	Specifications
Port A	Conforms to EIA RS-232C. D-Sub female 9-pin connector 5-V output (250 mA max.) through pin 6 (See note 1.)
Port B	Conforms to EIA RS-232C. D-Sub female 9-pin connector (See note 2.) 5-V output (250 mA max.) through pin 6. (See note 1.) Conforms to EIA RS-422/RS-485 (insulated) (NS15 only) 7-pin connector

Note 1: When using the 5 V outputs of serial ports A and B at the same time, the total current of A and B must be 250 mA or less.

Note 2: With the NS5, the *Expansion Interface* on the Comm Tab Page in the System Menu settings can be set to use a communications port in the expansion interface connector. The expansion interface, however, is a future expansion, which cannot yet be used. Always use the serial port B connector (D-Sub female 9-pin connector).
 (From Lot No. 01218, the expansion interface connector is not incorporated)

● **1:1 NT Link**

Item	Specifications
Communications standards	Conforms to EIA RS-232C.
Connectors	D-Sub female 9-pin connector (Serial ports A and B)
Number of Units connected	1:1
Transmission distance	Up to 15 m. (See note 1.)

• **1:N NT Links**

Item	Specifications
Communications standards	Conforms to EIA RS-232C.
Connectors	D-Sub female 9-pin connector (Serial ports A and B)
Number of Units connected	1:1 to 8
Transmission distance	Up to 15 m. (See note 2.)

- Note 1. When using an NS-AL002 Adapter, the transmission distance is as follows:
RS-422A cable: Up to 500 m total extended length.
2. The NS-AL002 is required when connecting two or more PTs to the host.
RS-422A cable: Up to 500 m total extended length.

• **Bar Code Reader**

Item	Specifications				
Communications standards	Conforms to EIA RS-232C.				
Communications settings	Start-stop synchronization Baud rate: 4,800, 9,600, or 19,200 bps Data length: 7 or 8 bits Stop bits: 1 or 2 bits Parity: None, odd, or even Flow control: RS/CS control				
Ports that can be connected	Either port A or port B only.				
Number of Units connected	1:1				
Transmission distance	Using PT serial port and D-Sub 6-pin	Using external power supply			
	2 m	15 m			
Communications protocol	No protocol mode				
Data format	<table border="1" style="display: inline-table; border-collapse: collapse;"> <tr> <td style="padding: 2px;">[STX]</td> <td style="padding: 2px;">Data (0 to 254 bytes)</td> <td style="padding: 2px;">[ETX]</td> </tr> </table>		[STX]	Data (0 to 254 bytes)	[ETX]
[STX]	Data (0 to 254 bytes)	[ETX]			
Power supply	Using PT serial port and D-Sub 6-pin	Using external power supply			
	5 V \pm 5% 250 mA max.	Depends on Bar Code Reader specifications.			

Ethernet Specifications (NS15-TX01□-V2, NS12-TS01(B)-V1, NS10-TV01(B)-V1, NS8-TV□1(B)-V1, NS5-SQ01(B)-V1, NS5-SQ□1(B)-V2, NS5-TQ□1(B)-V2, NS5-MQ□1(B)-V2)

Item	Specifications
Conformance standards	Conforms to IEEE 802.3 / Ethernet (10/100Base-T).
Transmission medium	2 pair Cat 3 UTP 22 to 26AWG, Cat 5, Cat 5e, Cat 6
Transmission distance	100 m (node-to-hub and hub-to-hub)
Connector	8-pin modular connector

• Ethernet

Item	Specifications
Network address	1 to 127
Node address	1 to 254
UDP port number	1024 to 65535 (See note 1.)
IP address	0.0.0.0 to 255.255.255.255 (See note 2.)
Subnet mask	0.0.0.0 to 255.255.255.255
Default gateway	0.0.0.0 to 255.255.255.255
IP proxy address	""(blank), 0.0.0.0 to 255.255.255.255
Conversion table	Node address: 1 to 253 IP address: 0.0.0.0 to 255.255.255.255

Note 1. The default UDP port number is 9600.

2. Do not set the following values for the IP address.

- Host ID with all bits set to 0 or 1. (Example: **192.168.21.0**)
- Net ID with all bits set to 0 or 1. (Example: **255.255.21.16**)
- Subnet ID with all bits set to 1. (Example: **192.168.255.16**)
- IP addresses that begin with 127. (Example: **127.35.21.16**)

• EtherNet/IP Specifications

Item	Specifications
Conformance standards	Conforms to IEEE 802.3 and Ethernet (10/100Base-T)
Transmission medium	Shielded twisted-pair (STP) cable, Category 5, 5e, or higher
Transmission distance	100 m (node-to-hub and hub-to-hub)
Connector	8-pin modular connector

• Controller Link Specifications (with NS-CLK21 Controller Link Interface Unit Mounted)

Item	Specification
Communications method	N:N token bus
Code	Manchester code
Modulation	Baseband code
Synchronization	Flag synchronization (conforming to HDLC frames)
Transmission path type	Multidrop (bus)
Baud rate and maximum transmission distance	The maximum transmission distances depends on the baud rate setting as follows: 2 Mbits/s: 500 m 1 Mbits/s: 800 m 500 Kbits/s: 1 km
Media	Specified shielded twisted-pair cable 2 signal lines and 1 shield
Connections to nodes	PLCs: Connected via terminal block Personal computers: Connected via special connector
Max. number of nodes	32 nodes
Communications functions	Data links and message service
Number of data link words	<ul style="list-style-type: none"> • Transmission area per node: 1,000 words max. (2,000 bytes) • Send/receive data link areas per SYSMAC CS-series PLC: 12,000 words max. (24,000 bytes) • Send/receive data link areas per SYSMAC C200HX/HG/HE, CVM1, or CV-series PLC: 8,000 words max. (16,000 bytes) • Send/receive data link areas per personal computer: 32,000 words max. (64,000 bytes) • Total send data link words on entire network: 32,000 words max. (64,000 bytes)
Data link areas	Bit (CIO, and LR Area), data memory (DM Area), expansion data memory (EM Area)
Message length	2,012 bytes max.

Item	Specification
RAS functions	<ul style="list-style-type: none"> • Polling unit backup function • Self-diagnosis (hardware check at startup) • Internode tests and broadcast test (via FINS commands) • Watchdog timer • Error log
Error correction	Manchester code check CRC check (CCITT $X^{16}+X^{12}+X^5+1$)

Note: A Controller Link Interface Unit can be used only for the NS15, NS12, and NS10 NS-series PTs.

• Video Input Specifications

Item	Specifications
Input system	NTSC (RS-170A compliant) or PAL
Scanning system (See note.)	Interlaced
Input signal	1.0 V p-p 75 Ω
Signal input connector	BNC connector

Note: The NS-series PTs do not support progressive scanning (i.e., non-interlaced scanning)

Item	Specifications
Model	NS-CA001 NS-CA002
Dimensions	150 x 90 x 21 mm (WxHxD) 150 x 102 x 22 mm (WxHxD)
Weight	0.5 kg or less
Ambient operating temperature	<ul style="list-style-type: none"> • NS12-V1/-V2 and NS10-V1/-V2 Mounting angle of 0° or greater but less than 30° to horizontal: 0 to 35°C Mounting angle of 30° or greater but less than 90° to horizontal: 0 to 50°C • NS8-V1/-V2 Mounting angle of 0° or greater but less than 30° to horizontal: 0 to 35°C Mounting angle of 30° min. but less than 90° to horizontal plane: 0 to 45°C Mounting angle of 90° to horizontal: 0 to 50°C • NS12-V1/-V2, NS10-V1/-V2, and NS8-V1/-V2 Mounting angle of 0° or greater but less than 30° to horizontal: 0 to 35°C Mounting angle of 30° or greater but less than 90° to horizontal: 0 to 45°C Mounting angle of 90° to horizontal: 0 to 50°C
Ambient storage temperature	-20 to 60°C
Ambient operating humidity	35% to 85% (with no condensation)
Rated power supply voltage (See note.)	Power supply used from NS-series PT expansion interface connector (5 V $\pm 5\%$, 3.3 V $\pm 5\%$).
Ambient operating atmosphere	No corrosive gases.
Vibration resistance	Conforms to NS-series PT specifications.
Shock resistance	Conforms to NS-series PT specifications.

Note: You can still use 5 V from either port A or port B on the NS-series PT after you mount a Video Unit on the PT.

Appendix 2 Dimensions

NS15 (Includes Mounting Dimensions)

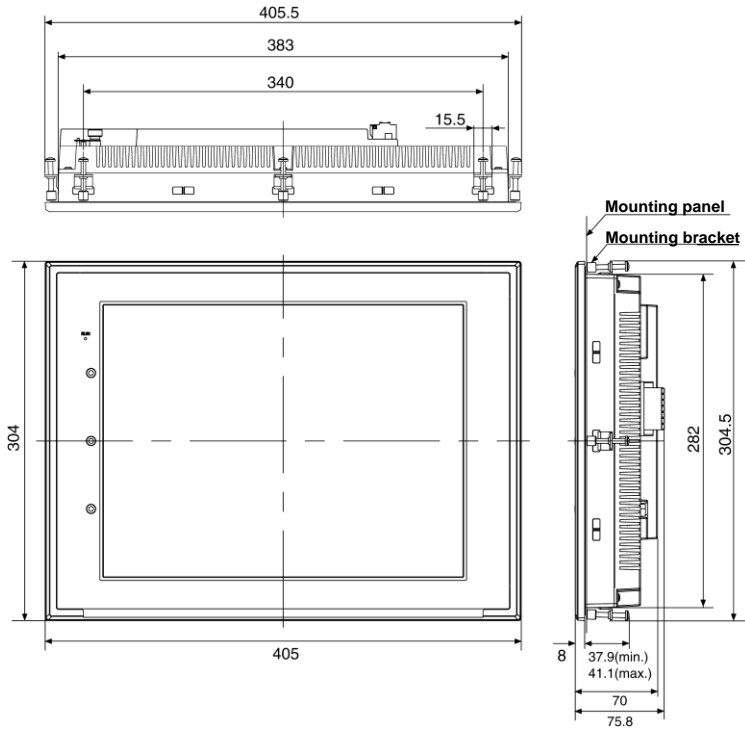

Note: The NS15 conforms to version-2 hardware standards.

With Controller Link Interface Unit Mounted

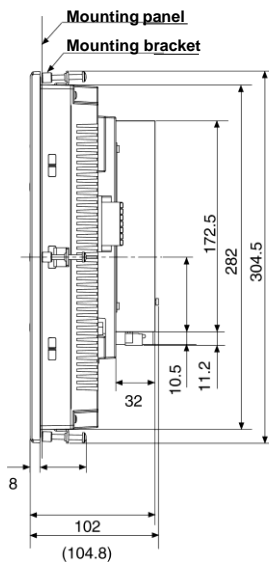

With Video Input Unit Mounted

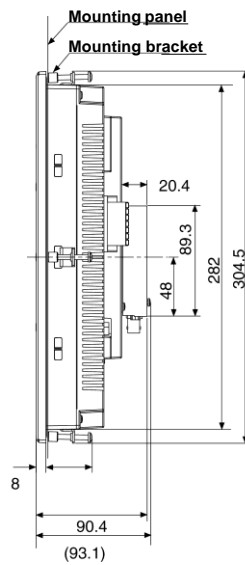

● NS15 Cable Connection Dimensions

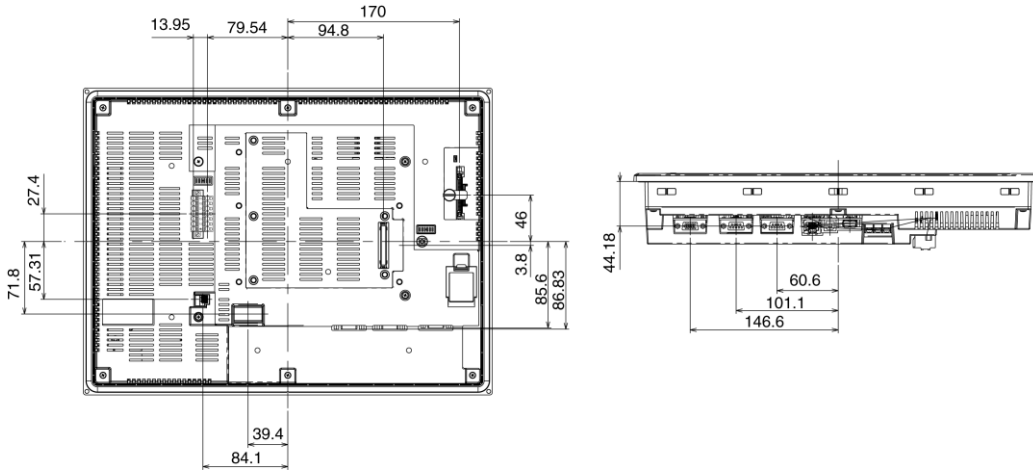

● NS15 Video Board (NS-CA001) Mounted Dimensions

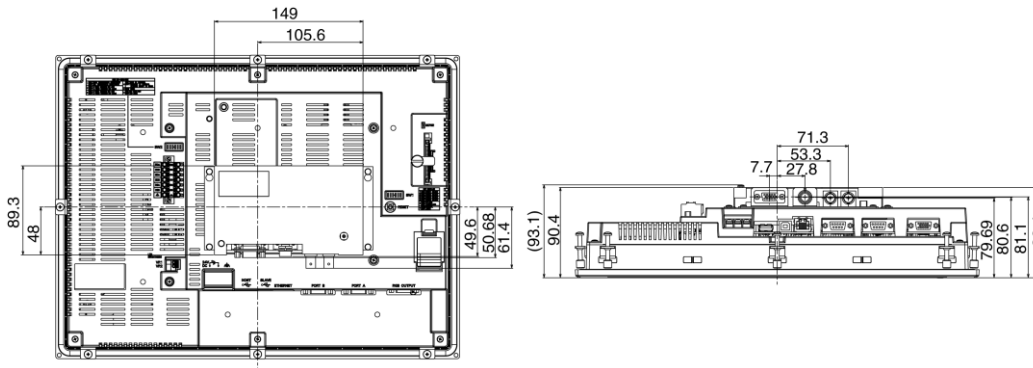

● NS15 Controller Link Interface Unit Mounted Dimensions

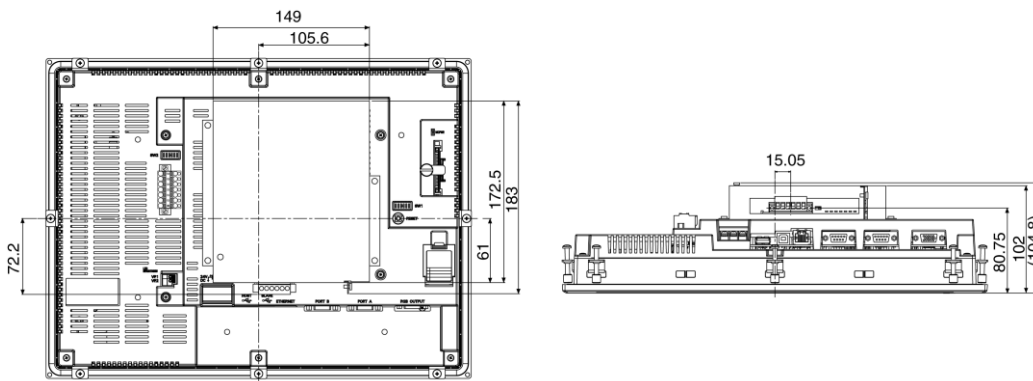

**NS12-V1/V2, NS10-V1/V2
(Includes Mounting Dimensions)**

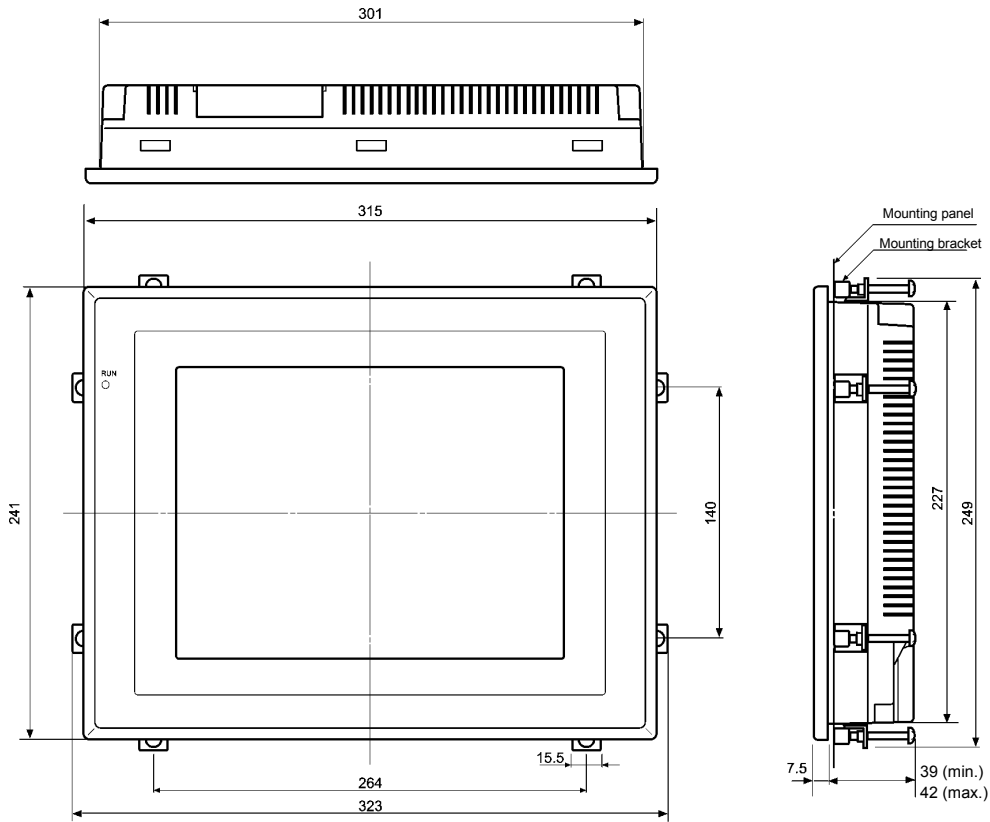

(Unit: mm)

With Controller Link Interface Unit Mounted

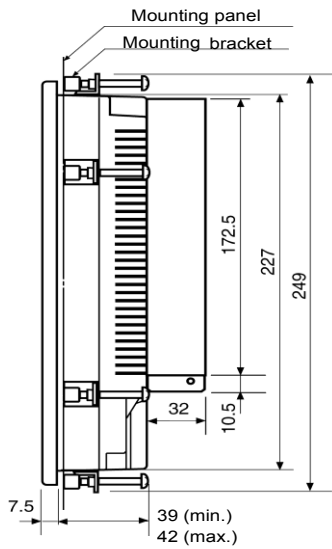

With Video Input Unit Mounted

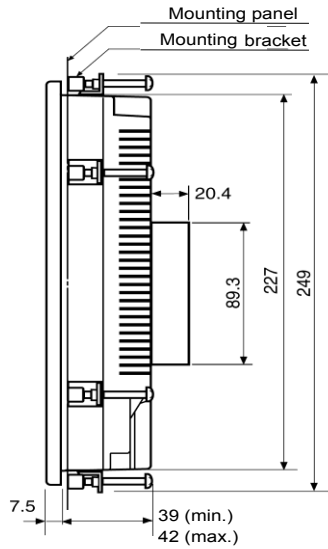

● NS12-V1/-V2, NS10-V1/-V2 Cable Connection Dimensions

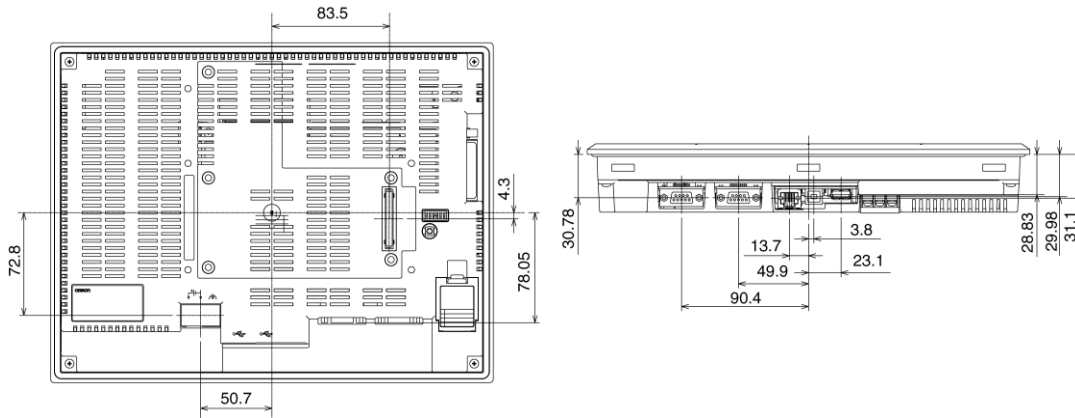

● NS12-V1/-V2 and NS10-V1/-V2 Video Board (NS-CA001) Mounted Dimensions

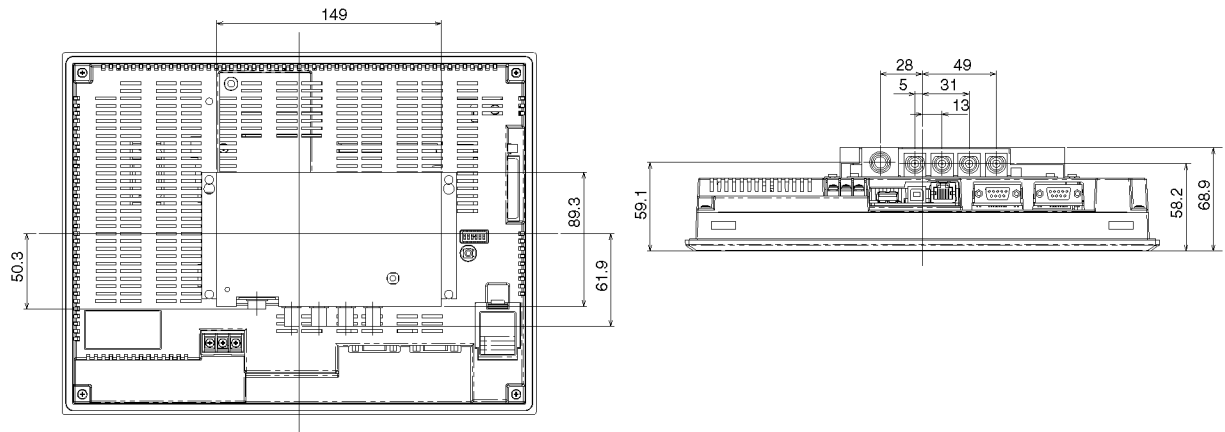

● NS12-V1/-V2 and NS10-V1/-V2 Video Board (NS-CA002) Mounted Dimensions

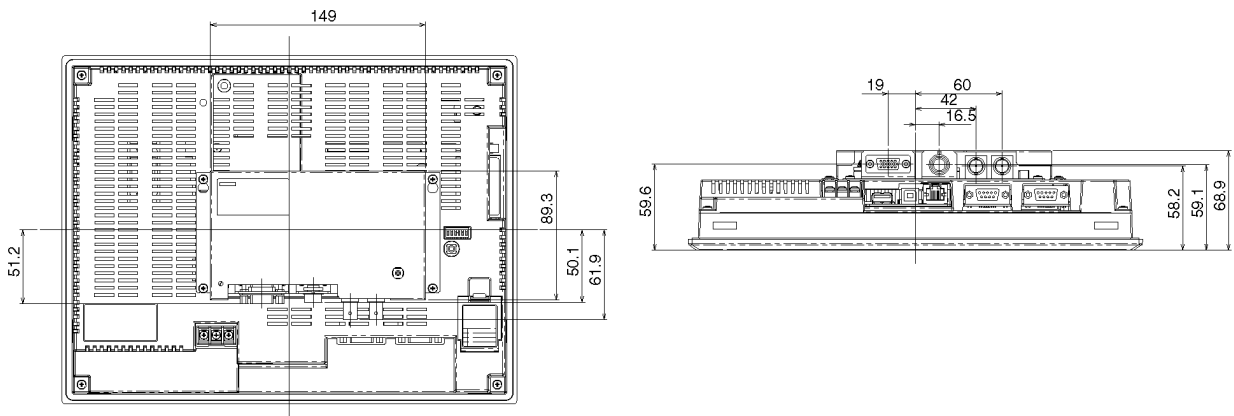

● NS12-V1/-V2 and NS10-V1/-V2 Controller Link Interface Unit Mounted Dimensions

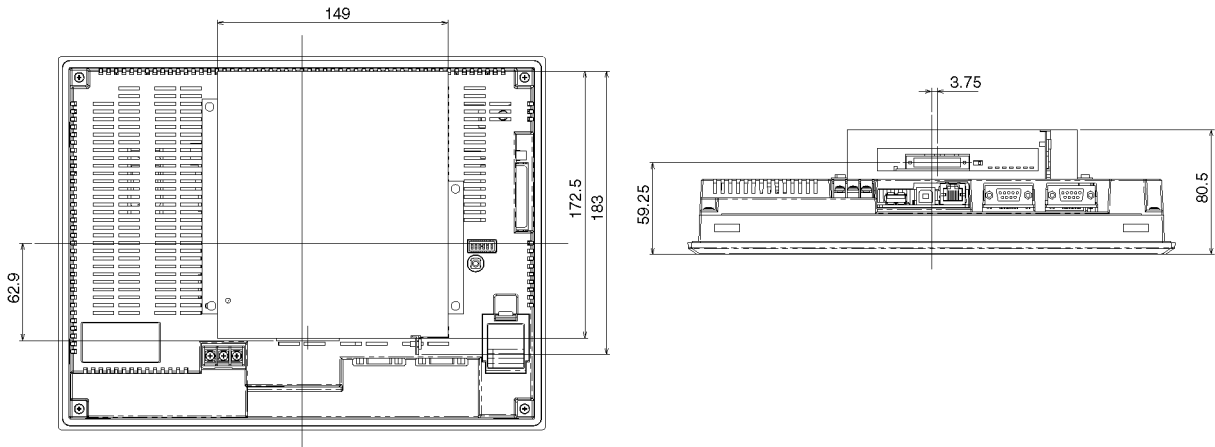

● NS12/NS10 (without "V1") Cable Connection Dimensions

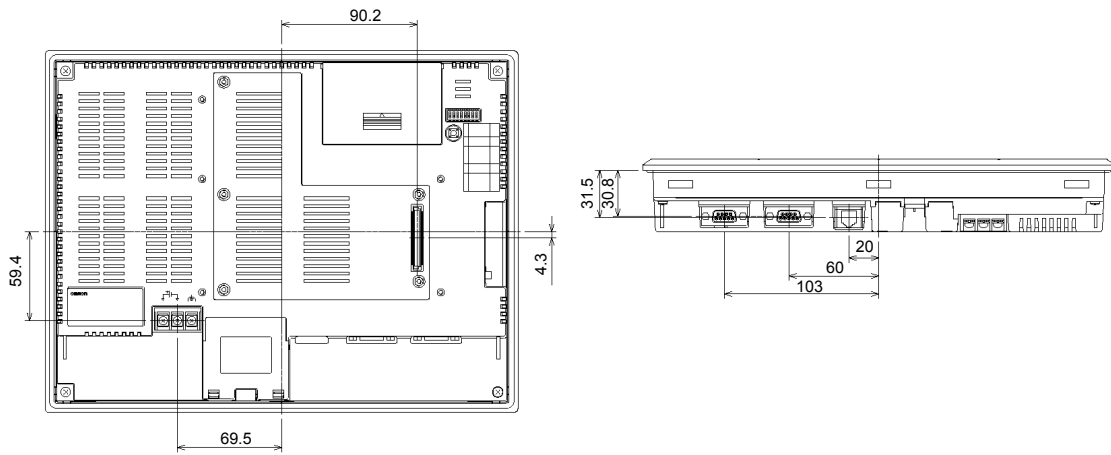

● NS8-V1/NS8-V2 Main Unit Dimensions (Mounted)

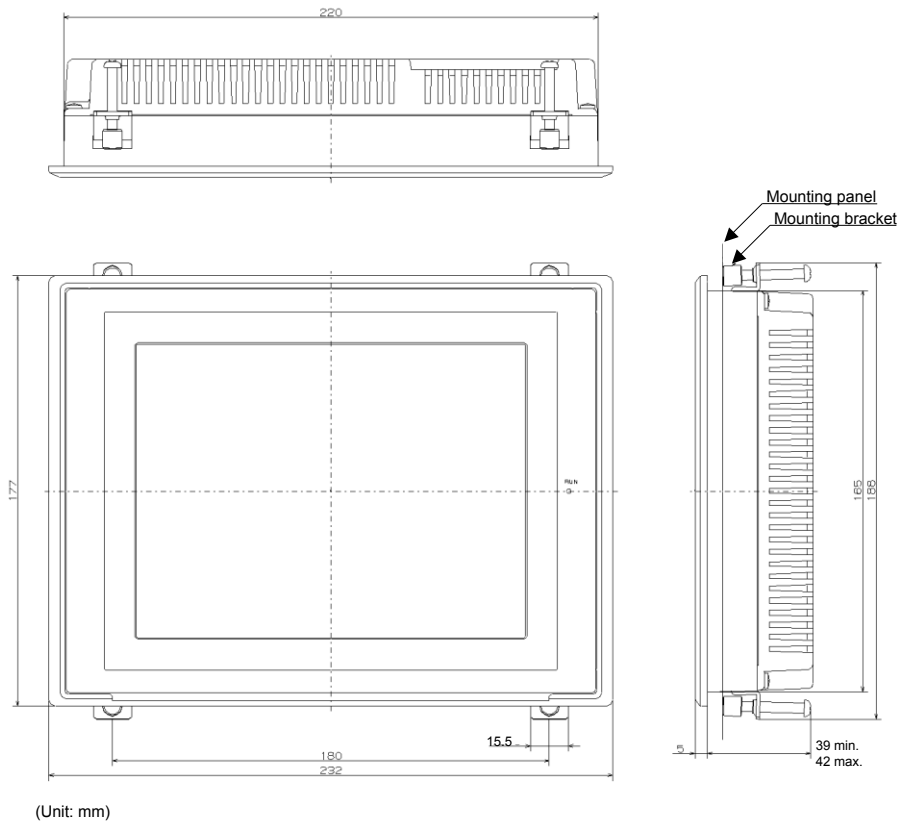

● NS8-V1/ NS8-V2 Cable Connection Dimensions

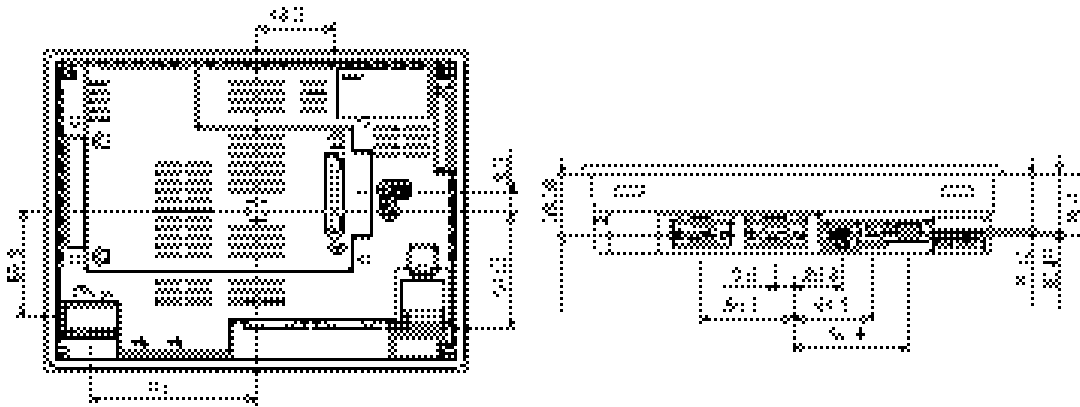

● NS8-V1/-V2 Video Board (NS-CA001) Mounted Dimensions

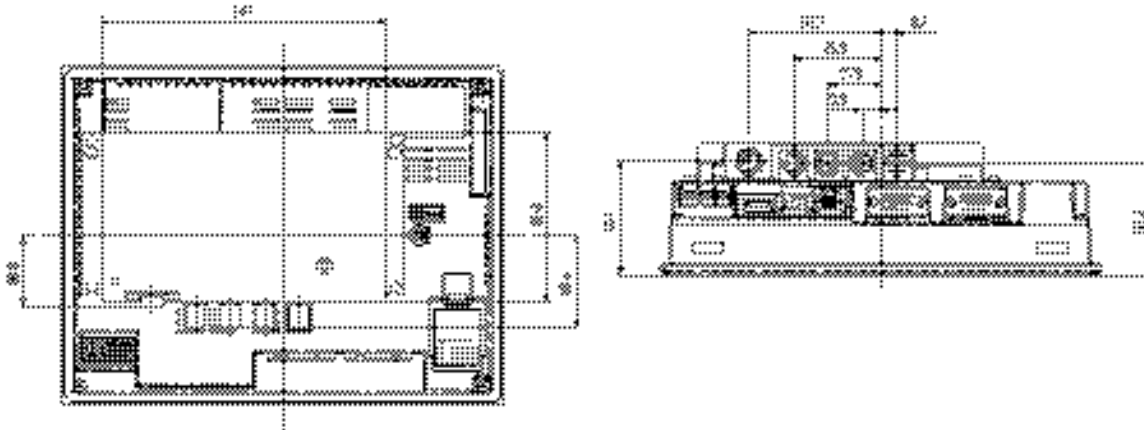

● NS8-V1/-V2 Video Board (NS-CA002) Mounted Dimensions

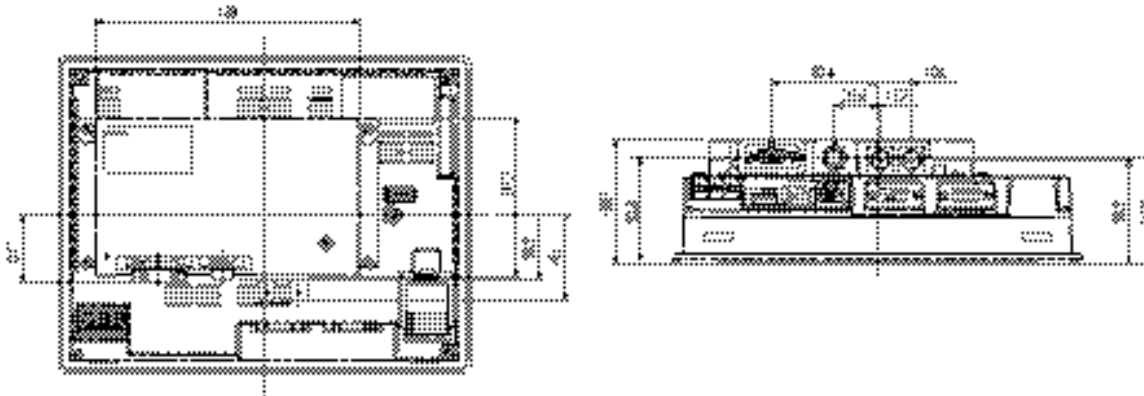

● NS5-V1/-V2 Cable Connection Dimensions

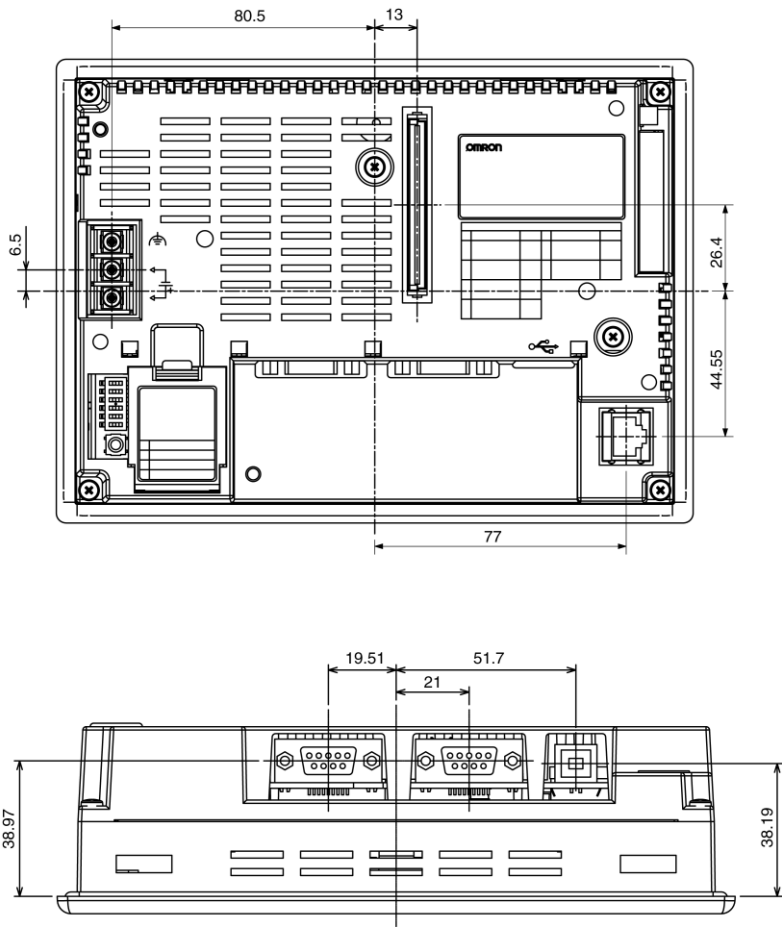

Appendix 3 Using NS-AL002 Converters

The NS-AL002 RS-232C/RS-422A Converter is connected directly to RS-232C port A or B of the PT, and converts RS-232C communications to RS-422A/RS-485. Any of the Converters listed in *Appendix 9 Standard Models* can be used. A summary of the NS-AL002 external dimensions, mounting and removal methods, and specifications is provided here. Refer to this information when designing the control panel. Refer to the *Instruction Sheet* included with the NS-AL002 for details.

Precautions for Correct Use

The NS-AL002 is an uninsulated RS-232C/RS-422A Converter. Therefore, if differences in ground potential or effects from noise are concerns, it is recommended that an insulated NT-AL001 RS-232C/RS-422A Converter be used instead. For details, refer to *Appendix 4 Using NT-AL001 Converters*.

A-3-1 Dimensions

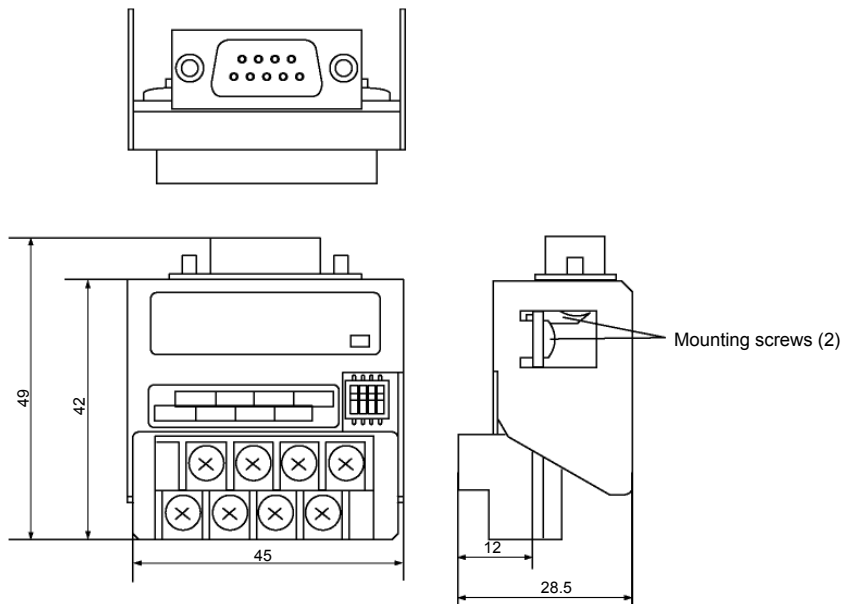

A-3-2 Mounting and Removing

Connect the NS-AL002 directly to port A or port B of the PT. Two NS-AL002 Adapters cannot be connected to ports A and B simultaneously.

Mount the Adapter by tightening and securing the mounting screws on both of the D-Sub connectors. The correct tightening torque is 0.3 N·m. The correct tightening torque for the terminal block is 0.5 N·m.

To remove the Adapter, loosen the screws and pull out the Adapter.

Precautions for Safe Use

- Always turn OFF the power to the PT before removing the Adapter.
- Do not touch the surface or the mounted parts of the Board with bare hands. Always discharge any static electricity from your body before handling the Board.

Precautions for Correct Use

- Mount to the PT after securely connecting the cable to the terminal block. Be sure to tighten the mounting screws on both of the D-Sub connectors. If the screws are loose, the FG terminals of the PT and NS-AL002 will not be connected.

A-3-3 Specifications

The following table shows the general specifications and communications specifications of the Adapter.

● General Specifications

Item	Specifications
Dimensions	45 × 49 × 28.5 mm (W × H × D)
Weight	50 g max.
Ambient operating temperature	0 to 50°C
Storage temperature	-20 to 60°C
Ambient operating humidity	35% to 85% (without condensation)
Rated power supply	5 V ±10% (through pin 6 of the RS-232C connector)
Power consumption	150 mW max.
Operating environment	No corrosive gases.
Vibration resistance	Conforms to PT specifications.
Shock resistance	Conforms to PT specifications.

Reference NS-series RS-485 (two-wire) communications are used to connect to an OMRON Temperature Controller. The NS-AL002 cannot be used with the NT-series PTs or PLCs.

● Communications Specifications

● RS-422A Interface

Item	Specifications
Baud rate	115.2 kbps max.
Transmission distance	500 m total length (See note 1.)
Terminal block format	8-terminal terminal block, M3.0
Insulation	No insulation (See note 2.)

Note 1: This specification is for a configuration in which all the Adapters connected on the same transmission path are NT-AL002 Link Adapters. If a CJ1W-CIF11 Conversion Adapter is used, the total length is 50 m.

Note 2: The RS-422A and RS-232C are not insulated.

A-3-4 DIP Switch Settings

The NS-AL002 Adapter has four DIP switch pins for setting the RS-422A communications conditions.

Set the DIP switch pins before connecting the cables to the Adapter.

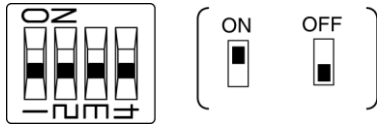

The factory setting for the DIP switch is all pins set to OFF.

Pin	Function	ON	OFF
Pin 1	Transmission mode	RS/CS control	Normal transmission
Pins 2 and 3	Two-wire/four-wire method selection	Two-wire method	Four-wire method
Pin 4	Terminating resistance	Yes	None

For 1:1 NT Link, set the RS-422A transmission mode to normal transmission (pin 1 OFF).
For 1:N NT Links (normal, high speed), set the RS-422A transmission mode to RS/CS control (pin 1 ON).

Note • Use the following DIP switch settings when connecting a CJ1W-CIF11 Conversion Adapter to the PT.

Pin	Function	Setting
Pin 1	Terminating resistance selection	ON: Terminating resistance enabled OFF: Terminating resistance disabled
Pin 2	Two-wire/four-wire method selection	OFF (four-wire)
Pin 3	Two-wire/four-wire method selection	OFF (four-wire)
Pin 4	Not used.	OFF
Pin 5	Selection of RS control for RD	OFF (no RS control)
Pin 6	Selection of RS control for SD	ON (RS control)

- When a CJ1W-CIF11 Conversion Adapter is used, the total transmission length is 50 m.
- If NT-001/NT-002 Link Adapters are used together with CJ1W-CIF11 Conversion Adapters on the same transmission path, the total transmission length is also 50 m.
- For details, refer to the *Appendix G* in the *SYSMAC CJ Series Operation Manual* (Cat. No. W393).

Precautions for Correct Use

Make sure that both of the mounting screws on the D-Sub connector are tightened to a torque of 0.3 N·m.

A-3-5 Pin Arrangement

The Adapter has a connector for RS-232C interface connection and a terminal block for RS-422A/485 interface connection.

The pin arrangements for the RS-232C connector and RS-422A/485 terminal block are as follows:

● RS-232C Connector

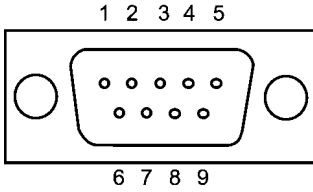

Terminal block pin number	Signal name	Signal direction Adapter ↔ PT
1	NC	
2	RD	←
3	SD	→
4	CS	← (RS signal short-circuited internally)
5	RS	→
6	5 V (30 mA max.)	←
7 or 8	NC	(Pins 7 and 8 are short-circuited.)
9	SG	–
Connector hood	FG	Connects to functional ground terminal of PT.

● RS-422A Terminal Block

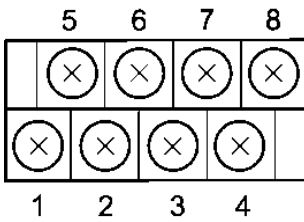

Terminal block pin number	Signal name	Signal direction Adapter ↔ Host
1	FG	Connects to functional ground terminal of PT.
2	RDB (+)	←
3	SDB (+)	→
4	RSB (+)	→
5	NC	---
6	RDA (-)	←
7	SDA (-)	→
8	RSA (-)	→

● Crimp Terminals

Use M3 crimp terminals.

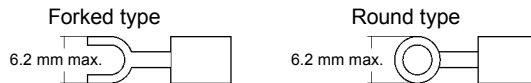

Applicable Crimp Terminal Examples

Forked type

Manufacturer	Model	Recommended cable size
J.S.T. Mfg. Co., Ltd.	V1.25-N3A	AWG22 to 16 (0.25 to 1.65 mm ²)
Molex	VSY1.25-3.5L	AWG22 to 16 (0.3 to 1.65 mm ²)

Round type

Manufacturer	Model	Recommended cable size
J.S.T. Mfg. Co., Ltd.	V1.25-MS3	AWG22 to 16 (0.25 to 1.65 mm ²)
Molex	RAV1.25-3	AWG22 to 16 (0.3 to 1.65 mm ²)

Recommended Cable

Manufacturer	Model
Tachii Electric Wire Co., Ltd.	TKV VBS3P-03T
HIRAKAWA HEWTECH CORP.	CO-HC-ESV-3P×7/0.2

A-3-6 Handling the Shield on RS-422A/485 Cables



Perform the following procedures to connect, process the shield, and connect to ground for communications systems using the NS-AL002. Incorrect connection may result in communications errors with the host.

● Connecting the NS-AL002 D-Sub Connector

Always securely tighten the screws on both sides of the D-Sub connector. Otherwise, the functional ground terminal (FG: ) of the PT will not be properly connected to the functional ground of the NS-AL002.

● Connecting the Ground Wire

The PT has a functional ground terminal (FG: ) .

- Ground according to *Figure (a)* for normal grounding.
 - Connect the ground terminal (GR) of the devices to the functional ground (FG: ) .
Make sure that each signal line is grounded at only one point and ground to 100 Ω max.
 - Short the LG terminal of the PLC to the ground terminal (GR).
 - Use a wire AWG14 to 20 for the ground wire.
 - Refer to the manual for individual Communications Units for details on proper wiring procedures.
- Do not ground the functional ground (FG: ) of the PT if it is mounted to the same panel as devices that generate noise, such as motors or inverters, as shown in *Figure (b)*.

● **Preparing the Shield of RS-422A/485 Connectors**

Always prepare RS-422A/485 cable shields properly. Otherwise, communications errors may occur with the host.

Ground only one end of the shield when connecting the ground terminal (GR) of the devices to the functional ground (FG: ) , and grounding each signal line at only one point and to 100 Ω max, as shown in *Figure (a)*.

Ground both ends of the shield when not grounding the functional ground (FG: ) of the PT, as shown in *Figure (b)*.

When using the CJ1W-CIF11 or when using the NT-AL001/NS-AL002 together with the CJ1W-CIF11, always performs connections, shield processing, and grounding as shown in *Figure (b)*.

● Example of Recommended Wiring

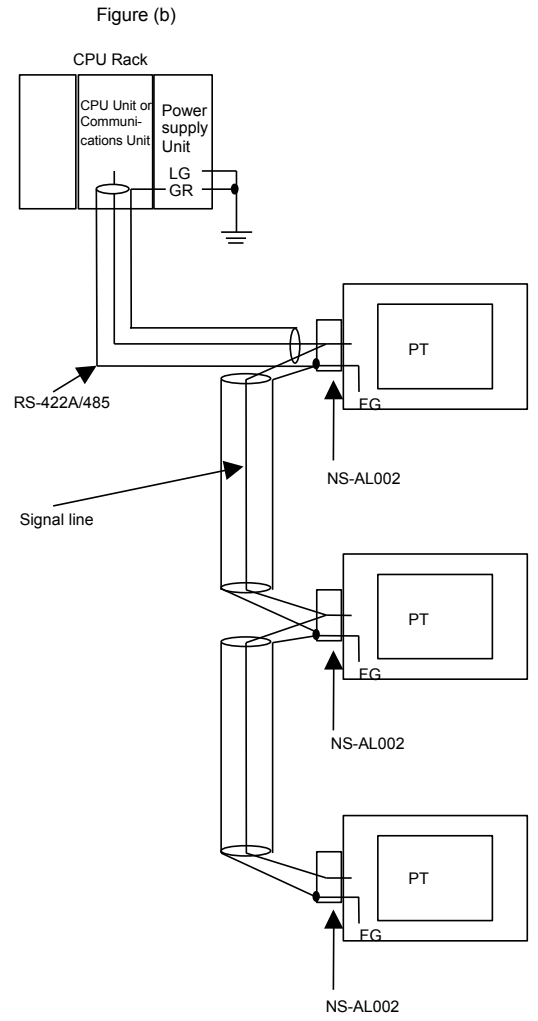
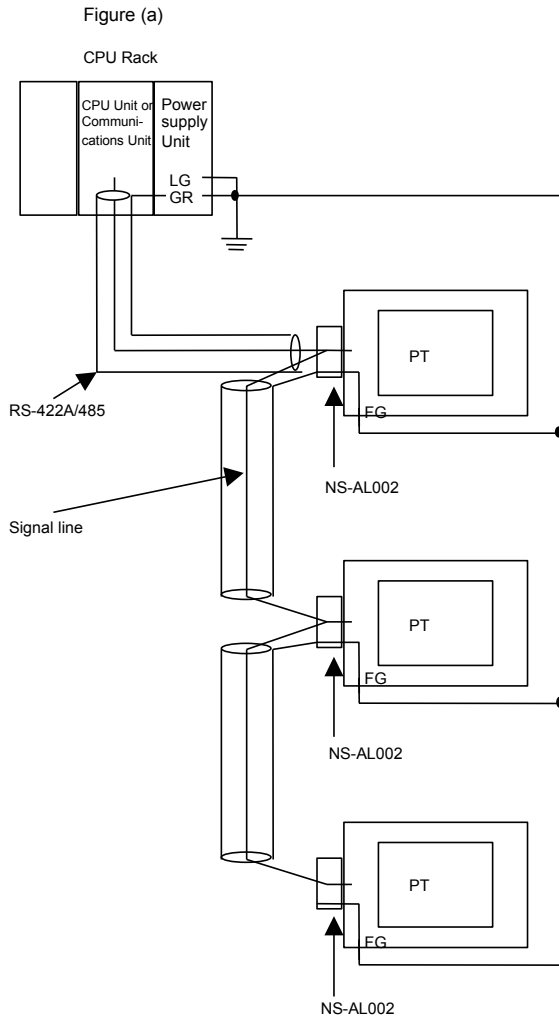

A-3-7 Connection Example

An example of connecting a PLC and a PT using an RS-232C/RS-422A Converter is shown below. Use the wiring example as reference for correct wiring.

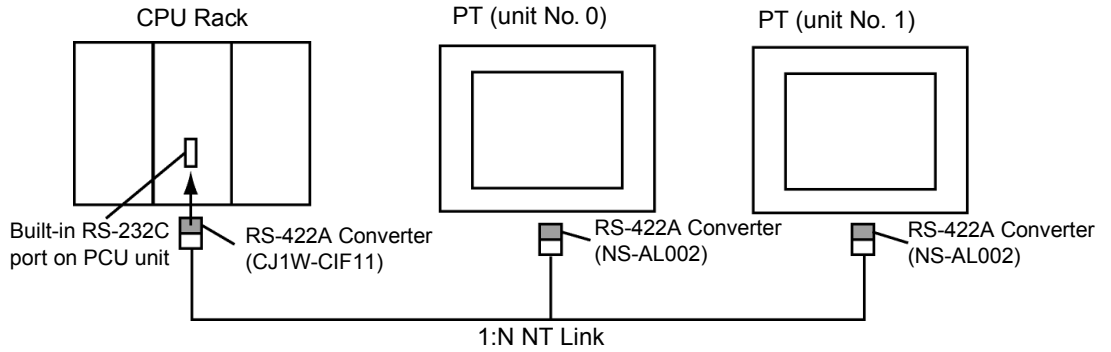

● Wiring Example

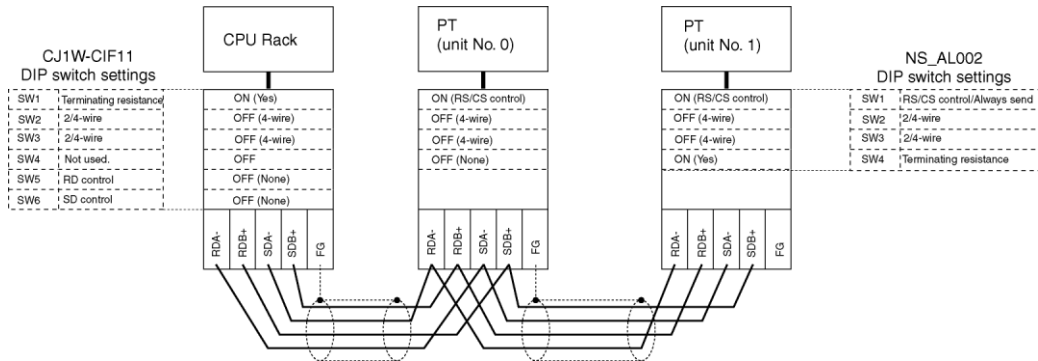

Note: Refer to A-3-6 *Handling the Shield on RS-422A/485 Cables* for information on processing the shield wire on the RS-422A/485 cable.

Note: If you use an RS-422A converter unit in NT-link (1:N) communication to allow multiple NSs to communicate at the same time, communication latency may occur depending on conditions. In this case, change the setting to communicate using port B.

Appendix 4 Using NT-AL001 Converters

This section outlines the external dimensions, procedure for mounting and removal, and specifications of an NT-AL001 RS-232C/RS-422A Converter. Refer to this information when designing the control panel. For details, refer to the instruction manual supplied with the NT-AL001.

A-4-1 Dimensions

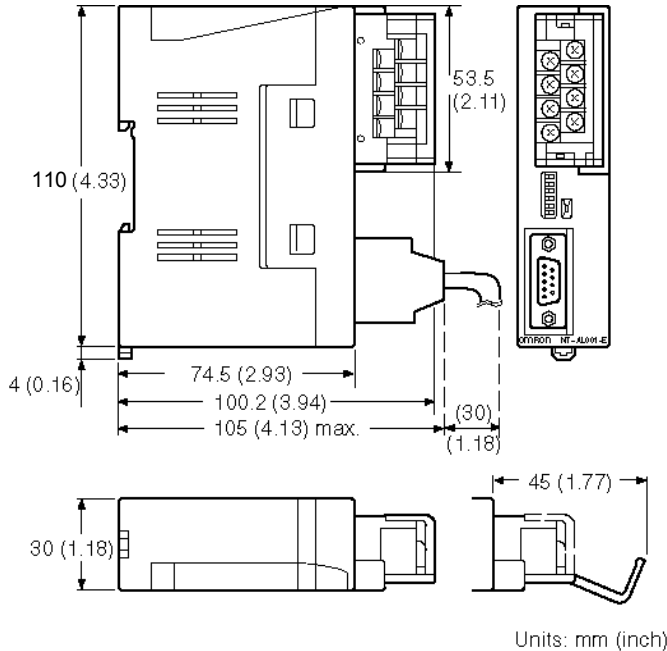

30 (W) × 114 (H) × 100.2 (D) mm: with the RS-422A terminal block cover closed
 30 (W) × 114 (H) × 119.5 (D) mm: with the RS-422A terminal block cover open

A-4-2 Methods for Mounting and Removal

The RS-232/RS-422 converter unit (NT-AL001) can be mounted on a DIN rail or in an operation panel.

The RS-422A terminal block of the converter unit can be easily removed.

Mounting to a DIN Rail

Latch the top part of the rear face of the converter unit (a in the figure) onto the top edge of the DIN rail, and push the unit in the direction indicated by b in the figure.

Now fit end plates at the right and left of the converter unit to secure it and ensure that it cannot shift laterally.

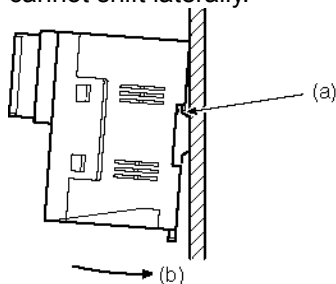

Removal from a DIN Rail

Remove the end plates at right and left of the converter unit and, as shown in the figure below, insert a flat blade screwdriver into the rail stopper at the bottom face of the converter unit and prize it free.

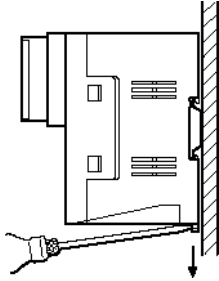

Mounting to an Operation Panel

Drill two mounting screw holes in an operation panel with a thickness of at least 2 mm (0.08 inch) and secure the converter unit with screws.

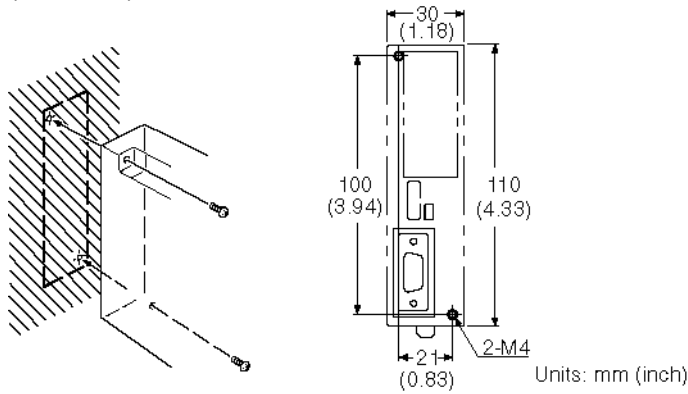

Precautions for Safe Use

In order to ensure a secure and strong mount, mount the converter unit in an operation panel with a thickness of at least 2 mm (0.08 inch).

A-4-3 Specifications

The general specifications and communications specifications of the converter unit are shown below.

General Specifications

Item	Specification
Dimensions	30 (W) × 114(H) × 100.2(D) mm: with the RS-422A terminal block cover closed 30 (W) × 114(H) × 119.5(D) mm: with the RS-422A terminal block cover open
Weight	200 g max.
Operating ambient temperature	0 to 55 °C
Operating ambient humidity	10% to 90% (with no condensation)
Rated power supply voltage	+5 V ±10% (using pin No. 6 of the RS-232C connector)
Rated power supply current	150 mA max.
Rush current	0.8 A max.
Insulation resistance	20 MΩ or higher, measured between all RS-422A terminal signal lines collectively and functional ground terminal with a 500 VDC Megger Tester.
Dielectric strength	1500 VAC for 1 minute between all RS-422A terminal signal lines collectively and functional ground terminal Leakage current: 10 mA max.
Operating environment	No corrosive gases
Storage ambient temperature	-20 to 75°C
Vibration resistance	Conforms to JIS C0911 60 minutes in each of X, Y, and Z directions
Shock resistance	Conforms to JIS C0912 147 m/s ² , 3 times in each of X, Y, and Z directions

Communications Specifications

RS-232C Interface

Item	Specification
Communications speed	115.2k max. bps
Transmission distance	2 m max.
Connector	9-pin D-SUB connector (female)

RS-422A/485 Interface

Item	Specification
Communications speed	115.2k max. bps (depends on the RS-232C communications speed)
Transmission distance	500 m max.
Connector	8-terminal detachable terminal block, M3.0

A-4-4 DIP Switch Settings

The converter unit has 6 digits DIP switch for setting the RS-422A/485 communication conditions.

Before connecting the cable to the converter unit, make the DIP switch settings.

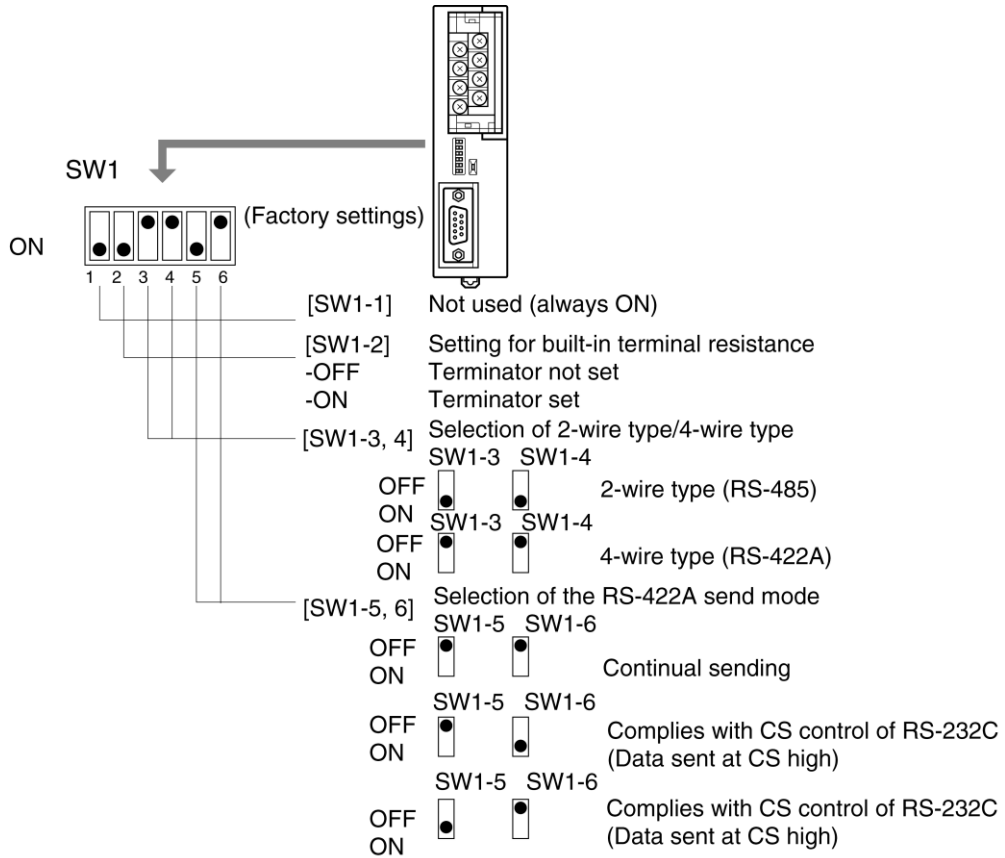

When using the host link or 1:1 NT Link, set the RS-422A send mode to continual sending (set both SW1-5 and 6 OFF).

When using the 1:N NT Link (standard or high-speed), set the RS-422A send mode to comply with CS control of RS-232C (i.e., one of SW1-5 and SW1-6 must be ON).

Precautions for Safe Use

- Do not set both SW1-5 and SW1-6 ON at the same time. This may damage internal circuits.
- The power supply to the device supplying +5 V must be turned OFF before starting wiring work.
- Before connecting the RS-232C cable and turning on the power to an RS-232C device such as a PT (i.e., turning on the power to the converter unit), check that the cable is wired correctly and that the DIP switch settings are correct. If the power is turned on while there is a wiring fault, the internal circuits of the converter unit or the RS-232C device may be damaged.
- When the converter unit is connected to a C200HX/HG/HE (-ZE), CQM1H, CS1G/H model of OMRON PLC as an RS-422A device, set DIP switches SW1-5 and SW1-6 as indicated below.

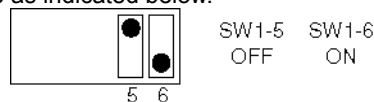

A-4-5 Pin Arrangement

The converter unit has a terminal block for an RS-422A/485 interface connection and a connector for an RS-232C interface connection. The pin arrangements for the RS-422A/485 terminal block and the RS-232C connector are as follows.

RS-422A/485 Terminal Block

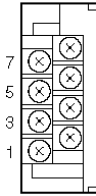

Terminal block pin No.	Signal name	Abbreviation	Signal direction (converter unit RS-422 device)
8	Request to send ()	CSA	
7	Request to send (+)	CSB	
6	Receive data ()	RDA	
5	Receive data (+)	RDB	
4	Send data ()	SDA	
3	Send data (+)	SDB	
2	Signal ground	SG (GND)	-
1	Functional ground		-

* The CSB and CSA signals are for specialized applications.

RS-232C Connector

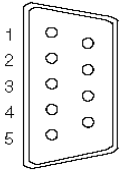

Connector pin No.	Signal name	Abbreviation	Signal direction (converter unit RS-232C device)
1	Not used	-	-
2	Send data	SD	
3	Receive data	RD	
4	Request to send (shorted to CS internally)	RS	
5	Clear to send (shorted to RS internally)	CS	
6	+5 V (150 mA) input for converter unit	+5 V	
7	Data set ready (shorted to ER internally)	DR	
8	Data terminal ready (shorted to DR internally)	ER	
9	Signal ground	SG	-

* The hood is connected to the functional ground terminal of the RS-422A terminal block.

A-4-6 Block Diagram

A diagram showing the internal blocks of the converter unit is shown below. Refer to this diagram when making cables yourself, or when connecting devices with special interfaces.

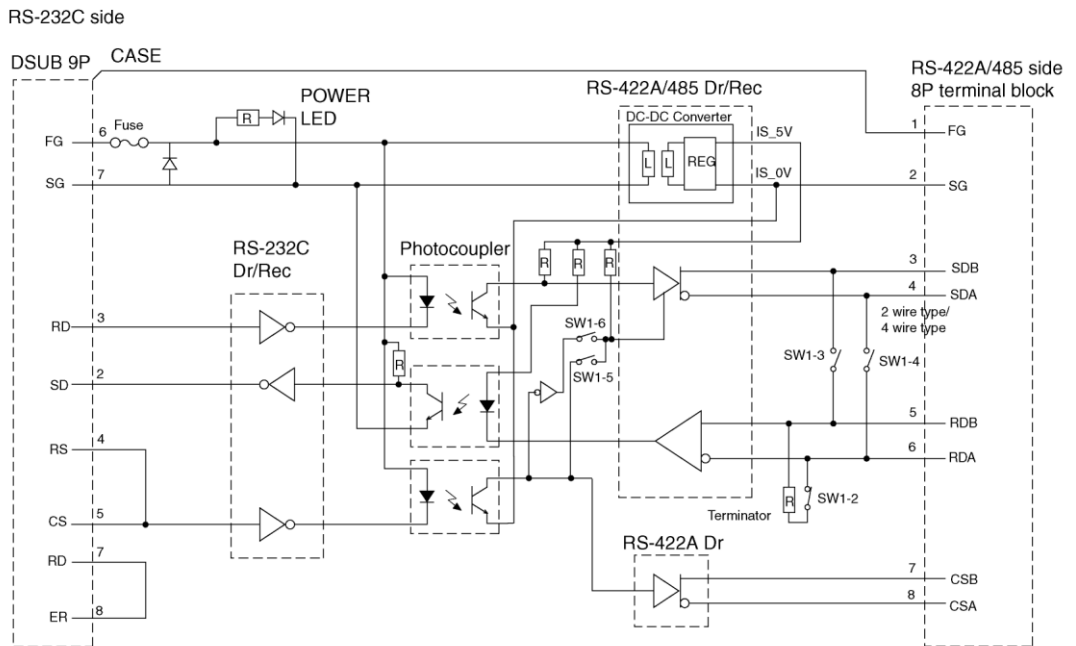

Appendix 5 Preparing Connecting Cables

Use the following procedure to prepare connecting cables.
Refer to this cable preparation method to prepare cables for the RS-232C/RS-422A Converter.

A-5-1 Cable Preparation

1. Cut the cables to the required length.
2. Remove the vinyl cable covering using a razor blade or other tool.
Use care not to damage the shield (braided mesh).
3. Cut the shield using scissors.
4. Strip back to the core of each wire using a stripper.
5. Bend back the shields.
6. Wrap the section of the shields that is bent back with aluminum foil tape.

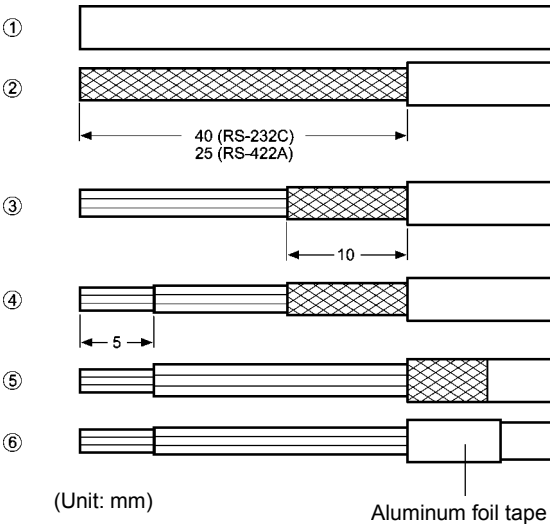

A-5-2 Soldering

1. Pass a heat-shrinking tube over each wire.
2. Pre-solder each wire and connector terminal.
3. Solder each of the wires to the connector terminals.

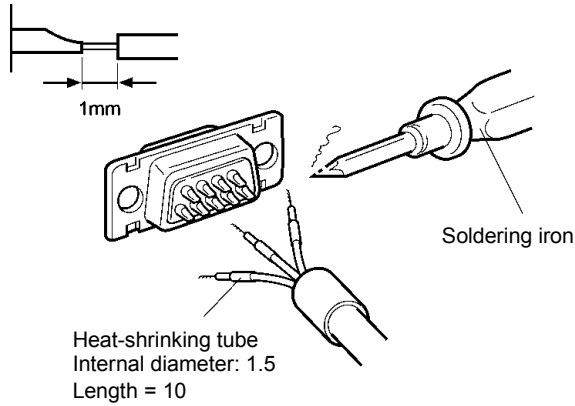

4. Replace the heat-shrinking tube up to the soldered section, and shrink the tube onto the wire by applying heat using a soldering gun.

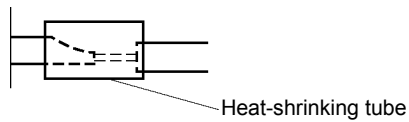

A-5-3 Hood Assembly

Assemble the hood as shown in the following diagram.

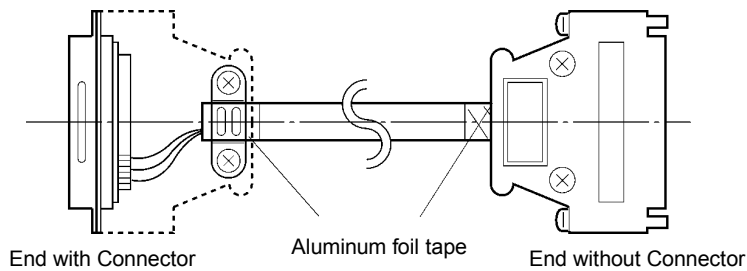

A-5-4 Preparing Connecting Cables for Host Connection

Refer to the following information when preparing the connecting cables for connecting the PT to the host.

● **Wiring Layout between PT and Host (RS-232C)**

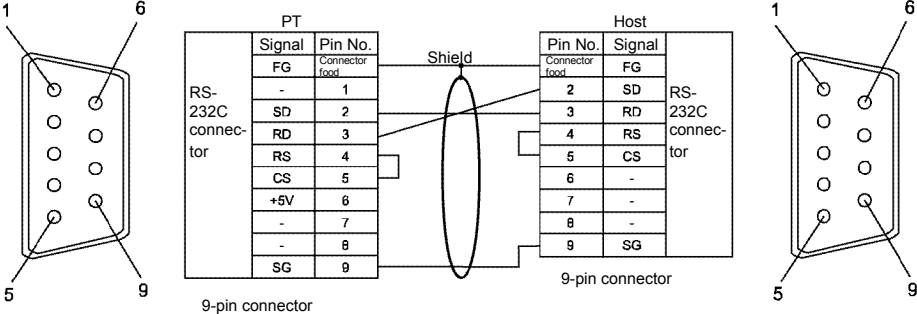

● **Wiring Layout between NS-AL002 and Host (RS-422A)**

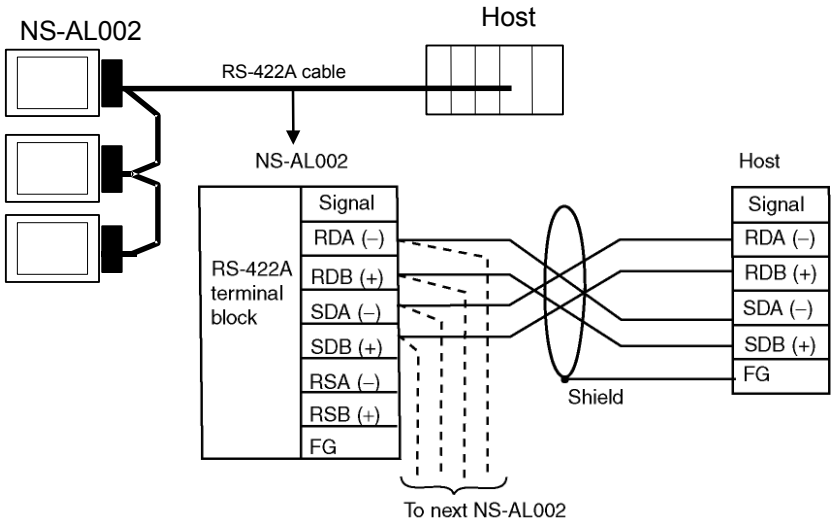

When connecting individual signals with twisted-pair cable, connect RDA and RDB, and SDA and SDB, as pairs in the twisted-pair cable. A communications error may occur if the pairs are not combined correctly.

● **Wiring Layout between NS-AL002 and NS-AL002 (RS-422A)**

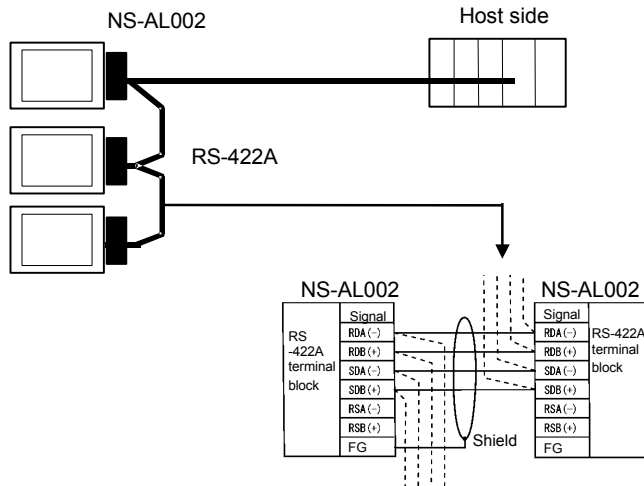

● **Wiring Layout between NT-AL001 and Host (RS-422A)**

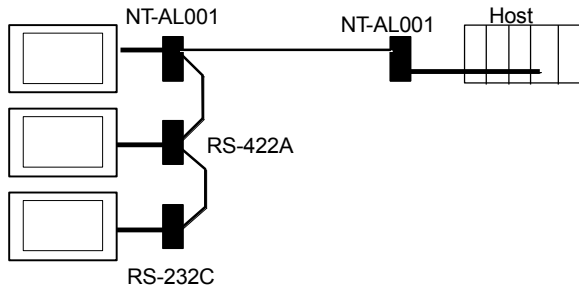

Usable Cables with Connectors

Host Link, NT Link (1:1), NT Link (N:1). +5 V provided from the PLC.

XW2Z-070T-1 (9-pin to 9-pin, 0.7 m)

XW2Z-200T-1 (9-pin to 9-pin, 2 m)

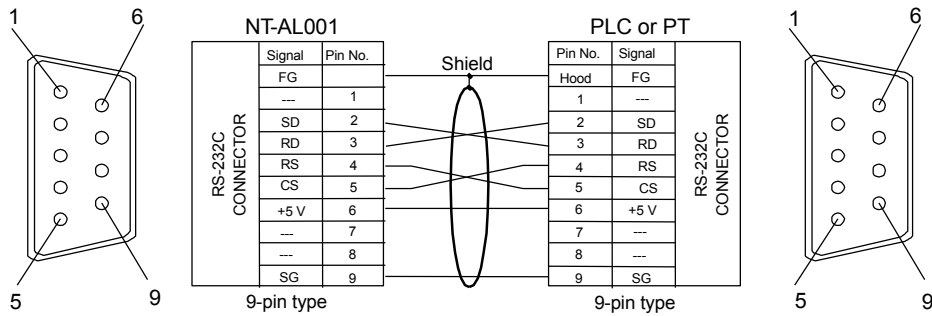

When connected to a PLC with a +5-V output, an external power supply is not required for the NT-AL001.

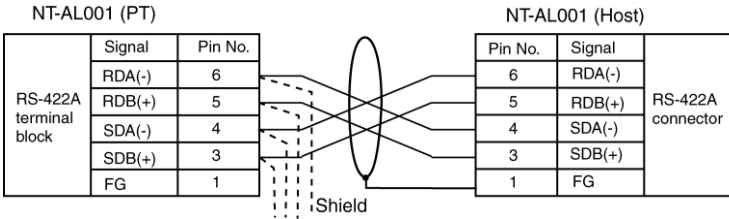

● **Wiring Layout between NT-AL001 and NT-AL001 (RS-422A)**

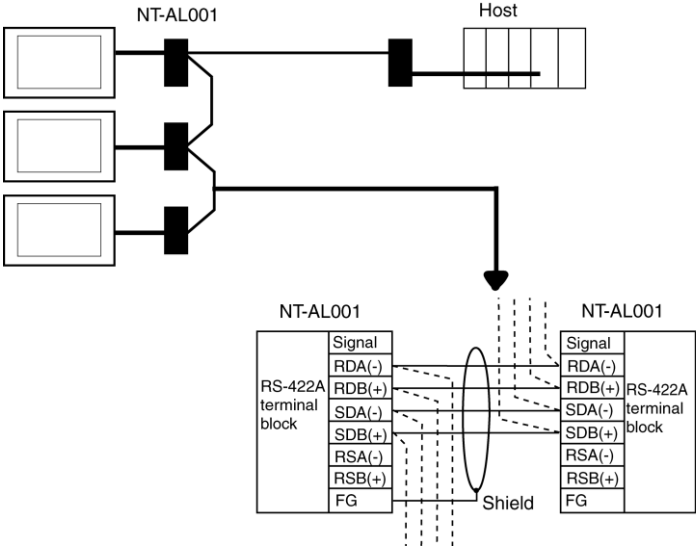

● **Wiring Layout to CS1G/H Serial Communications Boards, C200HX/HG/HE(-Z) Communications Boards, CQM1H Serial Communications Boards, and CVM1/CV Series Host Link Units**

Applicable Units:

- CS1G-CPU42(-V1), CS1G-CPU43(-V1), CS1G-CPU44(-V1), CS1G-CPU45(-V1), CS1H-CPU63(-V1), CS1H-CPU64(-V1), CS1H-CPU65(-V1), CS1H-CPU66(-V1), CS1H-CPU67(-V1), C200HE-CPU32(-Z), C200HE-CPU42(-Z), C200HG-CPU33(-Z), C200HG-CPU43(-Z), C200HG-CPU53(-Z), C200HG-CPU63(-Z), C200HX-CPU34(-Z), C200HX-CPU44(-Z), C200HX-CPU54(-Z), C200HX-CPU64(-Z), C200HX-CPU65-Z, C200HX-CPU85-Z, CQM1H-CPU51, CQM1H-CPU61, CV500-LK201(COM port 2)

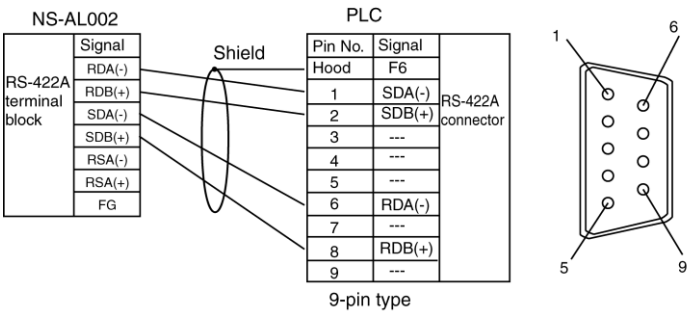

For details on processing shielded cable, refer to A-3-6 Handling the Shield on RS-422A/485 Cables.

● **Wiring Layout to CVM1/CV-series CPU Units**

Applicable Units:

CV500-CPU01-V1, CV1000-CPU01-V1, CV2000-CPU01-V1,
 CVM1-CPU01-V□, CVM1-CPU11-V□, CVM1-CPU21-V□

CVM1/CV Series CPU Units without the -V□ suffix cannot be connected by any communications method.

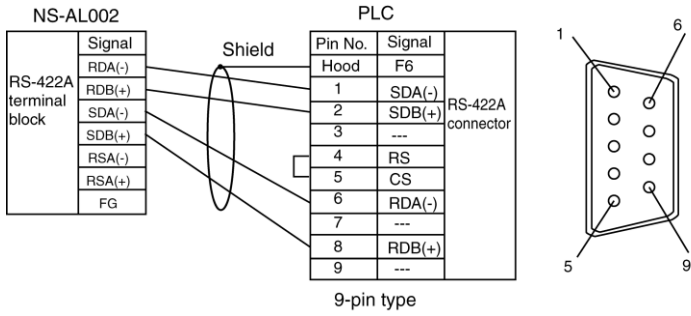

For details on processing shielded cable, refer to *A-3-6 Handling the Shield on RS-422A/485 Cables*.

Appendix 6 Preparing Cables for Computer Connection

Refer to the following information when preparing the CX-Designer connecting cables.

A-6-1 Connecting Cable Assembly

Wire the RS-232C connector to the DOS or 98-NX computer according to the type, as follows:

- **25-pin Connector**

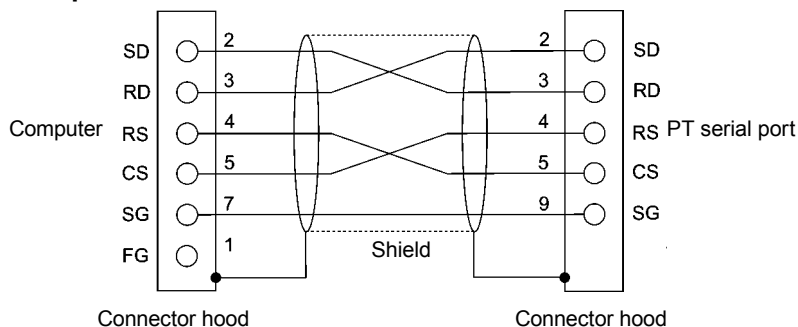

Use the following products to assemble the connecting cable.

Name	Model	Details
Connector	XM3D-2521 or equivalent	25-pin type Manufactured by OMRON (computer side)
	XM3A-0921 or equivalent	9-pin type Manufactured by OMRON (PT side)
Connector hood	XM2S-2511 or equivalent	25-pin type Manufactured by OMRON (computer side)
	XM2S-0911 or equivalent	9-pin type, mm screws Manufactured by OMRON (PT side)
Cable	AWG28 × 5P IFVV-SB	Multiconductor shielded cable Manufactured by Fujikura Densen.
	CO-MA-VV-SB 5P × 28AWG	Multiconductor shielded cable Manufactured by Hitachi Densen.

• 9-pin Connector

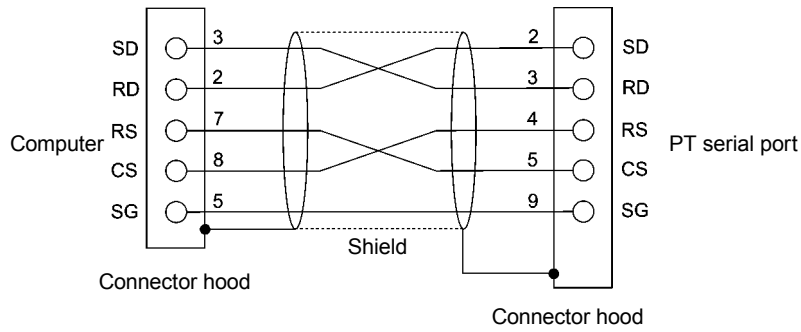

Use the following products to assemble the connecting cable.

Name	Model	Details
Connector	XM3D-0921 or equivalent	9-pin type Manufactured by OMRON (computer side)
	XM3A-0921 or equivalent	9-pin type Manufactured by OMRON (PT side)
Connector hood (See note.)	XM2S-0911 or equivalent	9-pin type, mm screws Manufactured by OMRON.
	XM2S-0913 or equivalent	9-pin type, inch screws Manufactured by OMRON.
Cable	AWG28 × 5P IFVV-SB	Multiconductor shielded cable Manufactured by Fujikura Densen.
	CO-MA-VV-SB 5P × 28AWG	Multiconductor shielded cable Manufactured by Hitachi Densen.

Note: Use a connector hood for the computer that conforms to the standards for the screws of the computer connector.

Appendix 7 Preparing Connecting Cables for Bar Code Readers

Refer to the following information when preparing the connecting cables for connecting the V520-RH21-6 Bar Code Reader.

• Connector Pin Arrangement

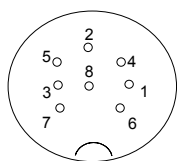

Connector pin arrangement at computer

Pin number	Signal name	Abbreviation	Signal direction	
			V520-RH21-6	PT
1	Send data	SD (TXD)	→	→
2	Receive data	RD (RXD)	←	←
3	Request to send	RS (RTS)	→	→
4	Clear to send	CS (CTS)	←	←
5	Not connected.			
6	Data terminal ready	ER (DTR)	→	→
7	0 V	SG		
8	Power supply (Vcc)	+5 V		

• Wiring Method

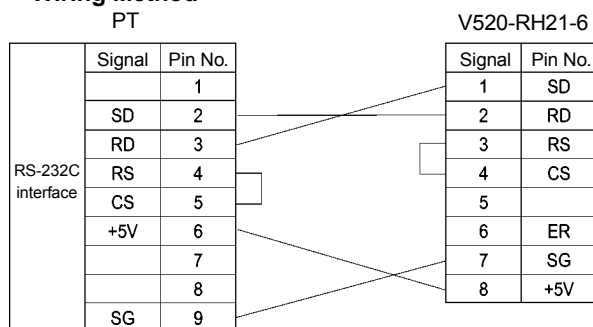

When connecting to the 5-V output of the PT's serial port, use a cable length of less than 2 m. If the cable is 2 m or longer, connect pins 7 and 8 of the Bar Code Reader to an external power supply.

• Connector Types

Use the following products to assemble the connecting cable.

Name	Model	Details
Connector	XM3A-0921 or equivalent	9-pin type Manufactured by OMRON (PT side)
	TCS2280-01-2011	8-pin DIN type Hoshiden, Co., Ltd. Panel-mounting type
Connector hood	XM2S-0911 or equivalent	9-pin type Manufactured by OMRON.
Cable	AWG28 × 5P IFVV-SB	Multiconductor shielded cable Manufactured by Fujikura Densen.
	CO-MA-VV-SB 5P × 28AWG	Multiconductor shielded cable Manufactured by Hitachi Densen.

Use the following cables if the V400-H111 or V400-H211 is used.

Model	Cable length
V400-W20-2M	2 m
V400-W20-5M	5 m

Appendix 8 Standard Models

Programmable Terminals (PTs)

Model	LCD				Ethernet	Case
	Type	Size	Color	Number of dots		Color
NS15-TX01S-V2	TFT	15.0 inch	Color	1024 × 768	10/100Base-T	Silver
NS15-TX01B-V2	TFT	15.0 inch	Color	1024 × 768	10/100Base-T	Black
NS12-TS01-V1	TFT	12.1 inch	Color	800 × 600	10/100Base-T	Ivory
NS12-TS01B-V1	TFT	12.1 inch	Color	800 × 600	10/100Base-T	Black
NS12-TS00-V1	TFT	12.1 inch	Color	800 × 600	Not supported.	Ivory
NS12-TS00B-V1	TFT	12.1 inch	Color	800 × 600	Not supported.	Black
NS12-TS01-V2	TFT	12.1 inch	Color	800 × 600	10/100Base-T	Ivory
(See note 3.)						
NS12-TS01B-V2	TFT	12.1 inch	Color	800 × 600	10/100Base-T	Black
(See note 3.)						
NS12-TS00-V2	TFT	12.1 inch	Color	800 × 600	Not supported.	Ivory
(See note 3.)						
NS12-TS00B-V2	TFT	12.1 inch	Color	800 × 600	Not supported.	Black
(See note 3.)						
NS10-TV01-V1	TFT	10.4 inch	Color	640 × 480	10/100Base-T	Ivory
NS10-TV01B -V1	TFT	10.4 inch	Color	640 × 480	10/100Base-T	Black
NS10-TV00 -V1	TFT	10.4 inch	Color	640 × 480	Not supported.	Ivory
NS10-TV00B-V1	TFT	10.4 inch	Color	640 × 480	Not supported.	Black
NS10-TV01-V2	TFT	10.4 inch	Color	640 × 480	10/100Base-T	Ivory
(See note 3.)						
NS10-TV01B-V2	TFT	10.4 inch	Color	640 × 480	10/100Base-T	Black
(See note 3.)						
NS10-TV00-V2	TFT	10.4 inch	Color	640 × 480	Not supported.	Ivory
(See note 3.)						
NS10-TV00B-V2	TFT	10.4 inch	Color	640 × 480	Not supported.	Black
(See note 3.)						
NS8-TV01-V1	TFT	8.0 inch	Color	640 × 480	10/100Base-T	Ivory
(See note 1.)						
NS8-TV01B-V1	TFT	8.0 inch	Color	640 × 480	10/100Base-T	Black
(See note 1.)						
NS8-TV11-V1	TFT	8.0 inch	Color	640 × 480	10/100Base-T	Ivory
(See note 1.)						
NS8-TV11B-V1	TFT	8.0 inch	Color	640 × 480	10/100Base-T	Black
(See note 1.)						
NS8-TV00 -V1	TFT	8.0 inch	Color	640 × 480	Not supported.	Ivory
(See note 1.)						
NS8-TV00B-V1	TFT	8.0 inch	Color	640 × 480	Not supported.	Black
(See note 1.)						
NS8-TV10 -V1	TFT	8.0 inch	Color	640 × 480	Not supported.	Ivory
(See note 1.)						
NS8-TV10B-V1	TFT	8.0 inch	Color	640 × 480	Not supported.	Black
(See note 1.)						
NS8-TV01-V2	TFT	8.4 inch	Color	640 × 480	10/100Base-T	Ivory
(See note 3.)						
NS8-TV01B-V2	TFT	8.4 inch	Color	640 × 480	10/100Base-T	Black
(See note 3.)						
NS8-TV00-V2	TFT	8.4 inch	Color	640 × 480	Not supported.	Ivory
(See note 3.)						

Model	LCD				Ethernet	Case
	Type	Size	Color	Number of dots		Color
NS8-TV00B-V2 (See note 3.)	TFT	8.4 inch	Color	640 × 480	Not supported.	Black
NS5-SQ01-V1 (See note 2.)	STN	5.7 inch	Color	320 × 240	10/100Base-T	Ivory
NS5-SQ01B-V1 (See note 2.)	STN	5.7 inch	Color	320 × 240	10/100Base-T	Black
NS5-SQ00-V1 (See note 2.)	STN	5.7 inch	Color	320 × 240	Not supported.	Ivory
NS5-SQ00B-V1 (See note 2.)	STN	5.7 inch	Color	320 × 240	Not supported.	Black
NS5-SQ01-V2 (See note 2.)	STN	5.7 inch	Color	320 × 240	10/100Base-T	Ivory
NS5-SQ01B-V2 (See note 2.)	STN	5.7 inch	Color	320 × 240	10/100Base-T	Black
NS5-SQ00-V2 (See note 2.)	STN	5.7 inch	Color	320 × 240	Not supported.	Ivory
NS5-SQ00B-V2 (See note 2.)	STN	5.7 inch	Color	320 × 240	Not supported.	Black
NS5-SQ11-V2 (See notes 3 and 4.)	TFT	5.7 inch	Color	320 × 240	10/100Base-T	Ivory
NS5-SQ11B-V2 (See notes 3 and 4.)	TFT	5.7 inch	Color	320 × 240	10/100Base-T	Black
NS5-SQ10-V2 (See notes 3 and 4.)	TFT	5.7 inch	Color	320 × 240	Not supported.	Ivory
NS5-SQ10B-V2 (See notes 3 and 4.)	TFT	5.7 inch	Color	320 × 240	Not supported.	Black
NS5-TQ01-V2 (See note 2.)	TFT	5.7 inch	Color	320 × 240	10/100Base-T	Ivory
NS5-TQ01B-V2 (See note 2.)	TFT	5.7 inch	Color	320 × 240	10/100Base-T	Black
NS5-TQ00-V2 (See note 2.)	TFT	5.7 inch	Color	320 × 240	Not supported.	Ivory
NS5-TQ00B-V2 (See note 2.)	TFT	5.7 inch	Color	320 × 240	Not supported.	Black
NS5-TQ11-V2 (See note 3.)	TFT	5.7 inch	Color	320 × 240	10/100Base-T	Ivory
NS5-TQ11B-V2 (See note 3.)	TFT	5.7 inch	Color	320 × 240	10/100Base-T	Black
NS5-TQ10-V2 (See note 3.)	TFT	5.7 inch	Color	320 × 240	Not supported.	Ivory
NS5-TQ10B-V2 (See note 3.)	TFT	5.7 inch	Color	320 × 240	Not supported.	Black
NS5-MQ01-V2 (See note 2.)	STN	5.7 inch	Mono- chrome	320 × 240	10/100Base-T	Ivory
NS5-MQ01B-V2 (See note 2.)	STN	5.7 inch	Mono- chrome	320 × 240	10/100Base-T	Black
NS5-MQ00-V2 (See note 2.)	STN	5.7 inch	Mono- chrome	320 × 240	Not supported.	Ivory
NS5-MQ00B-V2 (See note 2.)	STN	5.7 inch	Mono- chrome	320 × 240	Not supported.	Black
NS5-MQ11-V2 (See note 3.)	STN	5.7 inch	Mono- chrome	320 × 240	10/100Base-T	Ivory
NS5-MQ11B-V2 (See note 3.)	STN	5.7 inch	Mono- chrome	320 × 240	10/100Base-T	Black
NS5-MQ10-V2 (See note 3.)	STN	5.7 inch	Mono- chrome	320 × 240	Not supported.	Ivory

Model	LCD				Ethernet	Case
	Type	Size	Color	Number of dots		Color
NS5-MQ10B-V2 (See note 3.)	STN	5.7 inch	Mono- chrome	320 × 240	Not supported.	Black

- Note
1. The capacity of the NS8-TV00/TV01(B)-V1 is 6 Mbytes and the capacity of the NS8-TV10/TV11(B)-V1 is 20 Mbytes.
 2. The capacity of the NS5-SQ00/SQ01-V1 is 6 Mbytes and the capacity of the NS5-V2 is 20 Mbytes.
 3. The capacity of the NS15-TX01□-V2, NS12-V2, NS10-V2, NS8-V2, NS5-SQ1□-V2, NS5-TQ1□-V2, and NS5-MQ1□-V2 is 60 MB.
 4. Lot number 2110 or earlier use an STN LCD.

Serial Communications Units

Model	Specifications	Applicable PLC
CS1W-SCU21	<ul style="list-style-type: none"> • RS-232C (2 ports) • Base-mounting type 	CS-series CS1G/H and CS1G/H-H
CS1W-SCU41	<ul style="list-style-type: none"> • RS-232C (1 port) • RS-422A (1 port) • Base-mounting type 	CS-series CS1G/H and CS1G/H-H
CJ1W-SCU21/22	<ul style="list-style-type: none"> • RS-232C (2 ports) • Building block type 	CJ-series NJ-series
CJ1W-SCU31/32	<ul style="list-style-type: none"> • RS-422A (2 ports) • Building block type 	CJ-series NJ-series
CJ1W-SCU41/42	<ul style="list-style-type: none"> • RS-232C (1 port) • RS-422A (1 port) • Building block type 	CJ-series NJ-series

● CPU Units That Connect to PTs in 1:1 NT Links

PLC Series	Specifications
C200HE/HG/HX Series	With RS-232C connector (switching/9-pin type)
CQM1(H) Series	With RS-232C connector (9-pin type)
CPM1A Series	Connects to RS-232C cable using RS-232C Adapter CPM1-CIF01.
CPM2A Series	With RS-232C connector (9-pin type)
CPM2C Series	Connects to RS-232C connector branched using CPM2C-CN111 with converting cable.
CVM1/CV Series	With RS-232C connector (switching/9-pin type)

CPU Units That Connect in 1:1 NT Links via RS-232C to PT Serial Ports

PLC Series	CPU Units with built-in 1:1 NT Link functionality	CPU Units that connect via optional Communications Boards
C Series	C200HS-CPU21 C200HS-CPU23 C200HS-CPU31 C200HS-CPU33	---
	C200HE-CPU42 (-Z)	C200HE-CPU32 (-Z) (See note 1.) C200HE-CPU42 (-Z) (See note 1.)
	C200HG-CPU33(-Z) C200HG-CPU43(-Z) C200HG-CPU53(-Z) C200HG-CPU63(-Z)	C200HG-CPU33(-Z) (See note 1.) C200HG-CPU43(-Z) (See note 1.) C200HG-CPU53(-Z) (See note 1.) C200HG-CPU63(-Z) (See note 1.)
	C200HX-CPU34(-Z) C200HX-CPU44(-Z) C200HX-CPU54(-Z) C200HX-CPU64(-Z) C200HX-CPU65-Z C200HX-CPU85-Z	C200HX-CPU34(-Z) (See note 1.) C200HX-CPU44(-Z) (See note 1.) C200HX-CPU54(-Z) (See note 1.) C200HX-CPU64(-Z) (See note 1.) C200HX-CPU65-Z C200HX-CPU85-Z
	CQM1-CPU41-V1 CQM1-CPU42-V1 CQM1-CPU43-V1 CQM1-CPU44-V1 CQM1-CPU45-EV1	---
	CPM1A-10CD□□(-V1) CPM1A-20CD□□(-V1) CPM1A-30CD□□(-V1) CPM1A-40CD□□(-V1)	---
	CPM2A-30CD□□□□ CPM2A-40CD□□□□ CPM2A-60CD□□□□	---
	CPM2C-10□□□□□□□□ (See note 3.) CPM2C-20□□□□□□□□ (See note 3.)	---
	CQM1H-CPU21 CQM1H-CPU51 CQM1H-CPU61	CQM1H-CPU51 CQM1H-CPU61
	CV Series (See note 2.)	CV500-CPU01-V1 CV1000-CPU01-V1 CV2000-CPU01-V1
CVM1 Series (See note 2.)	CVM1-CPU01-V2 CVM1-CPU11-V2 CVM1-CPU21-V2	---

- Note 1. A C200HW-COM02/COM04/COM05/COM06-V1 Communications Board is required.
2. Connection is not possible to CVM1/CV-series PLC CPU Units without "-V1" in the model number.
3. A CS1W-CN118 Conversion Cable or XW2Z-200T-2 Cable with connector must be used for the connection.

Reference • CS-series CPU Units cannot connect to 1:1 NT Links, but a 1:1 connection can be made using 1:N NT Links (normal or high-speed). Refer to 4-2 *1:N Host Connection* and 4-3 *High-speed 1:N NT Link* for details.

● CPU Units That Connect in 1:1 NT Links via RS-422A to PT Serial Ports

PLC Series	CPU Units with built-in 1:1 NT Link functionality	
C Series	C200HE-CPU32 (-Z) (See note 1.) C200HE-CPU42 (-Z) (See note 1.)	
	C200HG-CPU33 (-Z) (See note 1.) C200HG-CPU43 (-Z) (See note 1.) C200HG-CPU53 (-Z) (See note 1.) C200HG-CPU63 (-Z) (See note 1.)	
	C200HX-CPU34 (-Z) (See note 1.) C200HX-CPU44 (-Z) (See note 1.) C200HX-CPU54 (-Z) (See note 1.) C200HX-CPU64 (-Z) (See note 1.) C200HX-CPU65-Z (See note 1.) C200HX-CPU85-Z (See note 1.)	
	CQM1H-CPU51 (See note 2.) CQM1H-CPU61 (See note 2.)	
	CV Series (See note 3.)	CV500-CPU01-V1 CV1000-CPU01-V1 CV2000-CPU01-V1
	CVM1 Series (See note 3.)	CVM1-CPU01-V2 CVM1-CPU11-V2 CVM1-CPU21-V2

- Note 1. A C200HW-COM03-V1 or C200HW-COM06-V1 Communications Board is required.
 2. A CQM1H-SCB41 Serial Communications Board is required.
 3. Connection is not possible to CVM1/CV-series PLC CPU Units without "-V1" in the model number.

Reference • NS-series RS-485 (two-wire) communications are used to connect to an OMRON Temperature Controller. The NS-AL002 cannot be used with the NT-series PTs or PLCs. Connect using RS-422A (4-wire).

● CPU Units That Connect to PTs in Standard 1:N NT Links

Model	Specifications
C200HE/HG/HX Series	With RS-232C connector (switching/9-pin type)
CQM1H Series	With RS-232C connector (9-pin type)
CS Series	With RS-232C connector (9-pin type)
CJ Series	With RS-232C connector (9-pin type)
NJ Series	With Serial Communications Unit (CJ1W-SCU22/32/42)
CP Series	With RS-232C connector (9-pin type/Terminal block) With Serial Option Board (CP1W-CIF01, CP1W-CIF11/12(-V1), CP2W-CIFD1, CP2W-CIFD2)

● CPU Units That Connect in 1:N NT Links via RS-232C to PT Serial Ports

PLC Series	Connecting with built-in ports	Connecting via optional Communications Boards or Units
CS Series	CS1G-CPU42(-V1) CS1G-CPU43(-V1) CS1G-CPU44(-V1) CS1G-CPU45(-V1) CS1H-CPU63(-V1) CS1H-CPU64(-V1) CS1H-CPU65(-V1) CS1H-CPU66(-V1) CS1H-CPU67(-V1) CS1G-CPU42H CS1G-CPU43H CS1G-CPU44H CS1G-CPU45H CS1H-CPU63H CS1H-CPU64H CS1H-CPU65H CS1H-CPU66H CS1H-CPU67H CS1D-CPU65H CS1D-CPU67H	Same as at left (See note 1).
CJ Series	CJ1G-CPU42H (See note 2.) CJ1G-CPU43H (See note 2.) CJ1G-CPU44H (See note 2.) CJ1G-CPU45H (See note 2.) CJ1M-CPU11 CJ1M-CPU12 CJ1M-CPU13 CJ1M-CPU21 CJ1M-CPU22 CJ1M-CPU23 CJ1H-CPU65H CJ1H-CPU66H CJ1H-CPU67H CJ1H-CPU65H-R CJ1H-CPU66H-R CJ1H-CPU67H-R CJ2H-CPU64(-EIP) CJ2H-CPU65(-EIP) CJ2H-CPU66(-EIP) CJ2H-CPU67(-EIP) CJ2H-CPU68(-EIP) CJ2M-CPU11 CJ2M-CPU12 CJ2M-CPU13 CJ2M-CPU14 CJ2M-CPU15 CJ2M-CPU31 (See note 3.) CJ2M-CPU32 (See note 3.) CJ2M-CPU33 (See note 3.) CJ2M-CPU34 (See note 3.) CJ2M-CPU35 (See note 3.)	CJ1G-CPU42H (See note 2.) CJ1G-CPU43H (See note 2.) CJ1G-CPU44H (See note 2.) CJ1G-CPU45H (See note 2.) CJ1M-CPU11 (See note 2.) CJ1M-CPU12 (See note 2.) CJ1M-CPU13 (See note 2.) CJ1M-CPU21 (See note 2.) CJ1M-CPU22 (See note 2.) CJ1M-CPU23 (See note 2.) CJ1H-CPU65H (See note 2.) CJ1H-CPU66H (See note 2.) CJ1H-CPU67H (See note 2.) CJ1H-CPU65H-R (See note 2.) CJ1H-CPU66H-R (See note 2.) CJ1H-CPU67H-R (See note 2.) CJ2H-CPU64(-EIP) (See note 2.) CJ2H-CPU65(-EIP) (See note 2.) CJ2H-CPU66(-EIP) (See note 2.) CJ2H-CPU67(-EIP) (See note 2.) CJ2H-CPU68(-EIP) (See note 2.) CJ2M-CPU11 (See note 2.) CJ2M-CPU12 (See note 2.) CJ2M-CPU13 (See note 2.) CJ2M-CPU14 (See note 2.) CJ2M-CPU15 (See note 2.) CJ2M-CPU31 (See note 3.) CJ2M-CPU32 (See note 3.) CJ2M-CPU33 (See note 3.) CJ2M-CPU34 (See note 3.) CJ2M-CPU35 (See note 3.)
NJ Series	---	NJ501-1500 (See note 6.) NJ501-1400 (See note 6.) NJ501-1300 (See note 6.) NJ301-1200 (See note 6.) NJ301-1100 (See note 6.) NJ101-1000 (See note 6.) NJ101-9000 (See note 6.)
CP Series	CP1E-N□□□□-□ CP2E-E□□□□-□ CP2E-S□□□□-□	CP1L-□□□□□-□ (See note 3.) CP1H-□□□□□-□ (See note 3.) CP2E-N□□□□-□ (See note 7.)

PLC Series	Connecting with built-in ports	Connecting via optional Communications Boards or Units
C Series	C200HE-CPU42(-Z)	C200HE-CPU32(-Z) (See note 4.) C200HE-CPU42(-Z) (See note 4.)
	C200HG-CPU43(-Z) C200HG-CPU63(-Z)	C200HG-CPU33(-Z) (See note 4.) C200HG-CPU43(-Z) (See note 4.) C200HG-CPU53(-Z) (See note 4.) C200HG-CPU63(-Z) (See note 4.)
	C200HX-CPU44(-Z) C200HX-CPU64(-Z) C200HX-CPU65-Z C200HX-CPU85-Z	C200HX-CPU34(-Z) (See note 4.) C200HX-CPU44(-Z) (See note 4.) C200HX-CPU54(-Z) (See note 4.) C200HX-CPU64(-Z) (See note 4.) C200HX-CPU65-Z (See note 4.) C200HX-CPU85-Z (See note 4.)
	---	CQM1H-CPU21 (See note 5.) CQM1H-CPU51 (See note 5.) CQM1H-CPU61 (See note 5.)

- Note
1. A CS1W-SCB21/SCB41 Serial Communications Board or a CS1W-SCU21 Serial Communications Unit is required.
 2. A CJ1W-SCU21/22/41/42 Serial Communications Unit is required.
 3. An RS-232C Option Board (CP1W-CIF01) is required.
 4. A C200HW-COM02/COM04/COM05/COM06(-V1) Communications Board is required.
 5. A CQM1H-SCB41 Serial Communications Board is required.
 6. A CJ1W-SCU22/42 Serial Communications Unit is required.
 7. An RS-232C Option Board (CP1W-CIF01, CP2W-CIFD1, or CP2W-CIFD2) is required.

Reference • NS-series RS-485 (two-wire) communications are used to connect to an OMRON Temperature Controller. The NS-AL002 cannot be used with the NT-series PTs or PLCs. Connect using RS-422A (4-wire).

● CPU Units That Connect in 1:N NT Links via RS-422A to PT Serial Ports

PLC Series	Unit	Serial Communications Board or Unit required for connection
CS Series	CS1G-CPU42(-V1) CS1G-CPU43(-V1) CS1G-CPU44(-V1) CS1G-CPU45(-V1) CS1H-CPU63(-V1) CS1H-CPU64(-V1) CS1H-CPU65(-V1) CS1H-CPU66(-V1) CS1H-CPU67(-V1) CS1G-CPU42H CS1G-CPU43H CS1G-CPU44H CS1G-CPU45H CS1H-CPU63H CS1H-CPU64H CS1H-CPU65H CS1H-CPU66H CS1H-CPU67H CS1D-CPU65H CS1D-CPU67H	CS1W-SCB41 Serial Communications Board

PLC Series	Unit	Serial Communications Board or Unit required for connection
CJ Series	CJ1G-CPU42H CJ1G-CPU43H CJ1G-CPU44H CJ1G-CPU45H CJ1M-CPU11 CJ1M-CPU12 CJ1M-CPU13 CJ1M-CPU21 CJ1M-CPU22 CJ1M-CPU23 CJ1H-CPU65H CJ1H-CPU66H CJ1H-CPU67H CJ1H-CPU65H-R CJ1H-CPU66H-R CJ1H-CPU67H-R CJ2H-CPU64(-EIP) CJ2H-CPU65(-EIP) CJ2H-CPU66(-EIP) CJ2H-CPU67(-EIP) CJ2H-CPU68(-EIP) CJ2M-CPU11 CJ2M-CPU12 CJ2M-CPU13 CJ2M-CPU14 CJ2M-CPU15 CJ2M-CPU31 (See note 1.) CJ2M-CPU32 (See note 1.) CJ2M-CPU33 (See note 1.) CJ2M-CPU34 (See note 1.) CJ2M-CPU35 (See note 1.)	CJ1W-SCU31/32/41/42 Serial Communications Unit RS-422A Option Board: CP1W-CIF11 or CP1W-CIF12(-V1) (See note 1.)
NJ Series	NJ501-1500 NJ501-1400 NJ501-1300 NJ301-1200 NJ301-1100 NJ101-1000 NJ101-9000	CJ1W-SCU32/42 Serial Communications Unit
CP Series	CP1E-N□□□□-□ CP1L-□□□□□-□ CP1H-□□□□□-□ CP2E-N□□D□-□ (See note 2.)	RS-422A Option Board: CP1W-CIF11 or CP1W-CIF12(-V1)
C Series	C200HE-CPU32(-Z) C200HE-CPU42(-Z) C200HG-CPU33(-Z) C200HG-CPU43(-Z) C200HG-CPU53(-Z) C200HG-CPU63(-Z)	C200HW-COM03/COM06(-V1) Communications Board
	C200HX-CPU34(-Z) C200HX-CPU44(-Z) C200HX-CPU54(-Z) C200HX-CPU64(-Z) C200HX-CPU65-Z C200HX-CPU85-Z	C200HW-COM03/COM06(-V1) Communications Board CQM1H-SCB41 Serial Communications Board
	CQM1H-CPU21 CQM1H-CPU51 CQM1H-CPU61	

Note 1: A CP1W-CIF11 or CP1W-CIF12(-V1) RS-422A Board is required to connect a CJ2M-CPU31/32/33/34/35 CPU Unit to the serial port on an NS-series PT.

2: CP2E series units (CP2E-S30/S40/S60) with the Built-in RS-485 Port (2-wire) cannot be connected with the NS via 2-wire RS-485.

Reference • Both the normal 1:N NT Links and high-speed NT Links are supported for CS-series PLC CPU Units with "-V1" in the model number. If the most recent Serial Communications Unit or Board is used, these connections are also supported by CPU Units without "-V1." Refer to 4-3 *High-speed 1:N NT Link* for details.

● **CPU Units That Connect to PTs in High-speed 1:N NT Links**

Model	Specifications
CS Series (See note.)	With RS-232C connector (9-pin type)
CJ Series	With RS-232C connector (9-pin type)
NJ Series	With Serial Communication Unit (CJ1W-SCU22/32/42)
CP Series	With RS-232C connector (9-pin type/Terminal block) With Serial Option Board (CP1W-CIF01, CP1W-CIF11/12(-V1), CP2W-CIFD1, CP2W-CIFD2)

Note: Connection is not possible for CPU Units without "-V1" in the model number.

● **CPU Units That Connect in 1:N NT Links via RS-232C to PT Serial Ports**

PLC Series	Unit	Serial Communications Board or Unit required for connection
CS Series	CS1G-CPU42-V1 (See note 1.) CS1G-CPU43-V1 (See note 1.) CS1G-CPU44-V1 (See note 1.) CS1G-CPU45-V1 (See note 1.) CS1H-CPU63-V1 (See note 1.) CS1H-CPU64-V1 (See note 1.) CS1H-CPU65-V1 (See note 1.) CS1H-CPU66-V1 (See note 1.) CS1H-CPU67-V1 (See note 1.) CS1G-CPU42H CS1G-CPU43H CS1G-CPU44H CS1G-CPU45H CS1H-CPU63H CS1H-CPU64H CS1H-CPU65H CS1H-CPU66H CS1H-CPU67H CS1D-CPU65H CS1D-CPU67H	Same as at left (See note 2).

PLC Series	Unit	Serial Communications Board or Unit required for connection
CJ Series	CJ1G-CPU42H CJ1G-CPU43H CJ1G-CPU44H CJ1G-CPU45H CJ1M-CPU11 CJ1M-CPU12 CJ1M-CPU13 CJ1M-CPU21 CJ1M-CPU22 CJ1M-CPU23 CJ1H-CPU65H CJ1H-CPU66H CJ1H-CPU67H CJ1H-CPU65H-R CJ1H-CPU66H-R CJ1H-CPU67H-R CJ2H-CPU64(-EIP) CJ2H-CPU65(-EIP) CJ2H-CPU66(-EIP) CJ2H-CPU67(-EIP) CJ2H-CPU68(-EIP) CJ2M-CPU11 CJ2M-CPU12 CJ2M-CPU13 CJ2M-CPU14 CJ2M-CPU15 CJ2M-CPU31 (See note 4.) CJ2M-CPU32 (See note 4.) CJ2M-CPU33 (See note 4.) CJ2M-CPU34 (See note 4.) CJ2M-CPU35 (See note 4.)	Same as at left (See note 3).
NJ Series	---	NJ501-1500 (See note 5.) NJ501-1400 (See note 5.) NJ501-1300 (See note 5.) NJ301-1200 (See note 5.) NJ301-1100 (See note 5.) NJ101-1000 (See note 5.) NJ101-9000 (See note 5.)
CP Series	CP1E-N□□□□-□ CP2E-E□□D□-□ CP2E-S□□D□-□	CP1L-□□□□-□ (See note 4.) CP1H-□□□□-□ (See note 4.) CP2E-N□□D□-□ (See note 6.)

- Note 1. CS-series PLC CPU Units without "-V1" in the model number do not support high-speed NT Links.
2. A CS1W-SCB21/SCB41 Serial Communications Board or a CS1W-SCU21 Serial Communications Unit is required.
3. A CJ1W-SCU41 Serial Communications Board is required.
4. An RS-232C Option Board (CP1W-CIF01) is required.
5. A CJ1W-SCU22/42 Serial Communications Unit is required.
6. An RS-232C Option Board (CP1W-CIF01, CP2W-CIFD1, or CP2W-CIFD2) is required.

CPU Units That Connect in 1:N NT Links via RS-422A to PT Serial Ports

PLC Series	Unit	Serial Communications Board or Unit required for connection
CS Series	CS1G-CPU42(-V1) CS1G-CPU43(-V1) CS1G-CPU44(-V1) CS1G-CPU45(-V1) CS1H-CPU63(-V1) CS1H-CPU64(-V1) CS1H-CPU65(-V1) CS1H-CPU66(-V1) CS1H-CPU67(-V1) CS1G-CPU42H CS1G-CPU43H CS1G-CPU44H CS1G-CPU45H CS1H-CPU63H CS1H-CPU64H CS1H-CPU65H CS1H-CPU66H CS1H-CPU67H CS1D-CPU65H CS1D-CPU67H	CS1W-SCB41 Serial Communications Board
CJ Series	CJ1G-CPU42H CJ1G-CPU43H CJ1G-CPU44H CJ1G-CPU45H CJ1M-CPU11 CJ1M-CPU12 CJ1M-CPU13 CJ1M-CPU21 CJ1M-CPU22 CJ1M-CPU23 CJ1H-CPU65H CJ1H-CPU66H CJ1H-CPU67H CJ1H-CPU65H-R CJ1H-CPU66H-R CJ1H-CPU67H-R CJ2H-CPU64(-EIP) CJ2H-CPU65(-EIP) CJ2H-CPU66(-EIP) CJ2H-CPU67(-EIP) CJ2H-CPU68(-EIP) CJ2M-CPU11 CJ2M-CPU12 CJ2M-CPU13 CJ2M-CPU14 CJ2M-CPU15 CJ2M-CPU31 (See note 1.) CJ2M-CPU32 (See note 1.) CJ2M-CPU33 (See note 1.) CJ2M-CPU34 (See note 1.) CJ2M-CPU35 (See note 1.)	CJ1W-SCU31/41 Serial Communications Unit RS-422A Option Board: CP1W-CIF11 or CP1W-CIF12(-V1) (See note 1.)

NJ Series	NJ501-1500 NJ501-1400 NJ501-1300 NJ301-1200 NJ301-1100 NJ101-1000 NJ101-9000	CJ1W-SCU32/42 Serial Communication Unit
CP Series	CP1E-N□□□□-□ CP1L-□□□□□-□ CP1H-□□□□□-□ CP2E-N□□D□-□ (See note 2.)	RS-422A Option Board: CP1W-CIF11 or CP1W-CIF12(-V1)

Note 1: A CP1W-CIF11 or CP1W-CIF12(-V1) RS-422A Board is required to connect a CJ2M-CPU31/32/33/34/35 CPU Unit to the serial port on an NS-series PT.

2: CP2E series units (CP2E-S30/S40/S60) with the Built-in RS-485 Port (2-wire) cannot be connected with the NS via 2-wire RS-485.

● CPU Units That Connect to PTs via Ethernet

PLC Series	CPU Unit	Specifications
CV Series	CV500-CPU01-V1 CV1000-CPU01-V1 CV2000-CPU01-V1	Mount a CV500-ENT01 Ethernet Unit (10Base-5). Mount a 10Base-T Adapter to the Ethernet Unit and a 10Base-T cable can also be used.
CVM1 Series	CVM1-CPU01-V2 CVM1-CPU11-V2 CVM1-CPU21-V2	
CS Series	CS1G-CPU42(-V1) CS1G-CPU43(-V1) CS1G-CPU44(-V1) CS1G-CPU45(-V1) CS1G-CPU42H CS1G-CPU43H CS1G-CPU44H CS1G-CPU45H CS1H-CPU63(-V1) CS1H-CPU64(-V1) CS1H-CPU65(-V1) CS1H-CPU66(-V1) CS1H-CPU67(-V1) CS1H-CPU63H CS1H-CPU64H CS1H-CPU65H CS1H-CPU66H CS1H-CPU67H CS1D-CPU65H CS1D-CPU67H	Mount a CS1W-ENT01 Ethernet Unit (10Base-5). Mount a 10Base-T Adapter to the Ethernet Unit and a 10Base-T cable can also be used. Mount a CS1W-ENT11 Ethernet Unit (10Base-T). Mount a CS1W-ETN21 Ethernet Unit (10Base-T/100Base-T). Mount a CS1D-ETN21D Ethernet Unit (100Base-T)

CJ Series	CJ1G-CPU42H CJ1G-CPU43H CJ1G-CPU44H CJ1G-CPU45H CJ1M-CPU11 CJ1M-CPU12 CJ1M-CPU13 CJ1M-CPU21 CJ1M-CPU22 CJ1M-CPU23 CJ1H-CPU65H CJ1H-CPU66H CJ1H-CPU67H CJ1H-CPU65H-R CJ1H-CPU66H-R CJ1H-CPU67H-R CJ2H-CPU64(-EIP) (See note 1.) CJ2H-CPU65(-EIP) (See note 1.) CJ2H-CPU66(-EIP) (See note 1.) CJ2H-CPU67(-EIP) (See note 1.) CJ2H-CPU68(-EIP) (See note 1.) CJ2M-CPU11 CJ2M-CPU12 CJ2M-CPU13 CJ2M-CPU14 CJ2M-CPU15 CJ2M-CPU31 (See note 1.) CJ2M-CPU32 (See note 1.) CJ2M-CPU33 (See note 1.) CJ2M-CPU34 (See note 1.) CJ2M-CPU35 (See note 1.)	Mount a CJ1W-ENT11 Ethernet Unit (10Base-T). Mount a CJ1W-ENT21 Ethernet Unit (10Base-T/100Base-T). Mount a CJ1W-EIP21 EtherNet/IP Unit (10Base-T/100Base-T).
CP Series	CP1L-□□□□□-□ CP1H-□□□□□-□ CP2E-N□□D□-□ (See note 2.)	Mount a CP1W-CIF41 Ethernet Option Board (10Base-T/100Base-T).

- Note 1. The CJ2H-CPU□□-EIP and CJ2M-CPU3□ CPU Units have a built-in Ethernet connector.
 2. CP2E-N□□D□-□ CPU Unit uses a Built-in Ethernet port. CP1W-CIF41 is not supported.

CPU Units That Connect to PTs via Controller Link

PLC Series	CPU Unit	Specifications
CS Series	All CS-series CPU Units	Mount a CS1W-CLK21 Controller Link Unit.
CJ Series	All CJ-series CPU Units	Mount a CJ1W-CLK21 Controller Link Unit.
C200HE/HG/HX Series (See note 1.)	C200HE-CPU32 (-Z) C200HE-CPU42 (-Z) C200HG-CPU33 (-Z) C200HG-CPU43 (-Z) C200HG-CPU53 (-Z) C200HG-CPU63 (-Z) C200HX-CPU34 (-Z) C200HX-CPU44 (-Z) C200HX-CPU54 (-Z) C200HX-CPU64 (-Z) C200HX-CPU65-Z C200HX-CPU85-Z	Mount a C200HW-CLK21 Controller Link Unit.
CQM1 Series	CQM1H-CPU51 CQM1H-CPU61	Mount a CQM1H-CLK21 Controller Link Unit.
CV Series (See note 2.)	All CV-series CPU Units	Mount a CVM1-CLK21 Controller Link Unit.
CVM1 Series (See note 2.)	All CVM1-series CPU Units	

- Note 1. The following are required when mounting a Controller Link Unit:
 C200HW-COM01/COM04 Communications Board
 C200HW-CE001/CE002/CE012 Bus Connection Unit

2. Always set routing tables when using a CVM1/CV-series CPU Unit manufactured in April 1996 or earlier. The manufacturing date can be checked with the 4-digit lot number given on the side of the CPU Unit, as shown below.

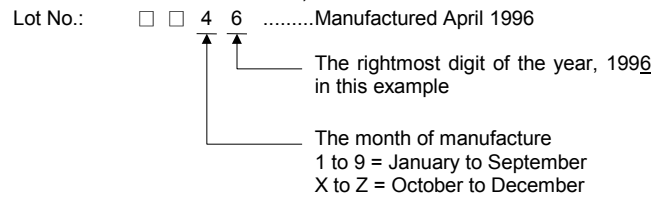

Refer to the *Controller Link Units Operation Manual* (Cat. No. W309) for setting methods for the PLC Controller Link Units.

● **EtherNet/IP-connectable NS-series PTs and Controllers**

EtherNet/IP-compatible NS-series PTs and System Versions

Model	NS15-TX01□-V2 NS12-TS□□(B)-V2 NS10-TV□□(B)-V2 NS8-TV□□(B)-V2 NS5-SQ1□(B)-V2 NS5-TQ1□ (B)-V2 NS5-MQ1□ (B)-V2
System version	CS/CJ Series: Version 8.0 or higher NJ101 Series: Version 8.6 or higher NJ301 Series: Version 8.6 or higher NJ501 Series: Version 8.5 or higher NX701 Series: Version 8.9 or higher NX102 Series: Version 8.96 or higher NX1P2 Series: Version 8.93 or higher

EtherNet/IP-connectable NS-series PTs and Controllers

Series name	Using the built-in board	Using an EtherNet/IP Unit	EtherNet/IP Unit required for connection
CS Series	/	CS1G-CPU42/43/44/45(-V1) CS1G-CPU42H/43H/44H/45H CS1H-CPU63/64/65/66/67(-V1) CS1H-CPU63H/64H/65H/66H/67H CS1D-CPU65H/67H	CS1W-EIP21 (100BASE-TX/10BASE-T)
CJ Series	CJ2H-CPU64/65/66/67/68-EIP CJ2M-CPU31/32/33/34/35	CJ1H-CPU65H/66H/67H CJ1H-CPU65H/66H/67H-R CJ1G-CPU42H/43H/44H/45H CJ1M-CPU11/12/13/21/22/23 CJ2H-CPU64/65/66/67/68 CJ2M-CPU11/12/13/14/15	CJ1W-EIP21 (100BASE-TX/10BASE-T)
NJ Series	NJ101-□□□□ NJ301-□□□□ NJ501-□□□□	NJ101-□□□□ NJ301-□□□□ NJ501-□□□□	CJ1W-EIP21 (See note.)
NX Series	NX701-□□□□ NX102-□□□□ NX1P2-□□□□	-	-

Note: The NJ-series Troubleshooter cannot be used. The following unit versions are required.
 NJ-series CPU Unit: Unit version 1.01 or later
 EtherNet/IP Unit: Unit version 2.1 or later

RS-232C/RS-422A Converters

Model	Specifications
NT-AL001	RS-232C: 9-pin connector RS-422A: 8-pin terminal block
NS-AL002	RS-232C: 9-pin connector RS-422A: 8-pin terminal block
CJ1W-CIF11	RS-232C: 9-pin connector RS-422A: 5-pin terminal block

- Reference**
- When a CJ1W-CIF11 Conversion Adapter is used, the total transmission length is 50 m.
 - If NT-001/NS-002 Link Adapters are used together with CJ1W-CIF11 Conversion Adapters on the same transmission path, the total transmission length is also 50 m.

Software Related to NS-series PTs

Name	Model	Details
CX-One	CXONE-AL□□□-V4	
CX-One Lite	CXONE-LT01C-V4	
Sysmac Studio	SYSMAC SE2□□□	

Support Tools

Name	Model	Details
Optional products	NS15-KBA04	Anti-reflection Sheets for NS15
	NS12-KBA04	Anti-reflection Sheets for NS12/NS10
	NS7-KBA04	Anti-reflection Sheets for NS8
	NT30-KBA04	Anti-reflection Sheets for NS5
	NS12-KBA05	Protective Cover for NS12 and NS10 (anti-reflection coating)
	NS7-KBA05	Protective Cover for NS8 (anti-reflection coating)
	NT31C-KBA05	Protective Cover for NS5 (anti-reflection coating)
	NS15-KBA05N	Transparent Protective Cover for NS15
	NS12-KBA05 N	Transparent Protective Cover for NS12 and NS10
	NS7-KBA05N	Transparent Protective Cover for NS8
	NT31C-KBA05N	Transparent Protective Cover for NS5
	NT30-KBA01	Chemical-resistant Cover for NS5
	CJ1W-BAT01	Replacement Battery for NS15/NS12/NS10/NS8/NS5
	HMC-EF372	Memory Card (30 Mbytes)
	HMC-EF672	Memory Card (64 Mbytes)
	HMC-EF283	Memory Card (256 Mbytes)
	HMC-EF583	Memory Card (512 Mbytes)
HMC-AP001	Memory Card Adapter (for connecting Personal Computer PC Card Reader/Writer)	

Note: The CX-Designer includes a transfer program and standard PT system program.

Connecting Cables and Connectors

Cable with Connector (PT-to-PLC)

Model	Cable length	Applicable Units	Communications method	Specifications
XW2Z-200T	2 m	Units with 9-pin connector and built-in 1:1 NT Link function.	NT Link (RS-232C only)	9-pin-to-9-pin
XW2Z-500T	5 m			
XW2Z-200T-2	2 m	CPM2C peripheral port	NT Link (RS-232C only)	9-pin-to-CPM2C peripheral port
XW2Z-500T-2	5 m			

Cable with Connector (PT-to-Personal Computer)

Model	Cable length	Applicable computer	Specifications
XW2Z-S002	2 m	DOS and 98NX computers	Female 9-pin-to-male 9-pin

Ethernet Cable (PT-to-Personal Computer)

Particular models are not specified, but use a cable that meets the following specifications.

Item	Specifications
Conformance standards	Conforms to IEEE 802.3 / Ethernet (10/100Base-T).
Transmission medium	2 pair Cat 3 UTP 22-26AWG, Cat 5, Cat 5e, Cat 6
Transmission distance	100 m (node-to-hub and hub-to-hub)
Connector	8-pin modular connector

EtherNet/IP Cables

Use the twisted-pair cables that are recommended in *5-3-2 Selecting Network Configuration Devices*.

Item	Specifications
Conformance standards	Conforms to IEEE 802.3 and Ethernet (10/100Base-T).
Transmission medium	Shielded twisted-pair (STP) cable, Category 5, 5e, or higher
Transmission distance	100 m (node-to-hub and hub-to-hub)
Connector	8-pin modular connector

RS-232C Connecting Cable

Model	Specifications
AWG28 × 5P IFVV-SB	Multiconductor shielded cable Manufactured by Fujikura Densen.
CO-MA-VV-SB 5P × 28AWG	Multiconductor shielded cable Manufactured by Hitachi Densen.

USB Cables with Ferrite Cores

Model	Specifications
FH-VUAB2M	Cable length: 2 m
FH-VUAB5M	Cable length: 5 m

Controller Link Communications Cable

Use one of the twisted-pair cables listed below as the communications cable.

Model	Manufacturer	Remarks
Li2Y-FCY2x0.56qmm	KROMBERG & SHUBERT, Department KOMTEC	German company
1x2xAWG-20PE+Tr. CUSN+PVC	DRAKA CABLES INDUSTRIAL	Spanish company
#9207	BELDEN	American company
ESVC0.5x2C	Bando Densen Co.	Japanese company
ESNC0.5x2C-99-087B	Nihon Electric Wire & Cable Co.	Japanese company

Applicable Connectors for RS-232C

Name	Model	Specifications
Connector	XM3A-2521 or equivalent	25-pin type (male), Manufactured by OMRON.
	XM3D-2521 or equivalent	25-pin type (female), Manufactured by OMRON. (for DOS computers)
	XM3A-0921 or equivalent	9-pin type (male), Manufactured by OMRON.
	XM3D-0921 or equivalent	9-pin type (female), Manufactured by OMRON. (for DOS computers)
	DB-25P	25-pin type (male), Manufactured by JAE.
Connector hood	XM2S-2511 or equivalent	25-pin type, mm screws, Manufactured by OMRON.
	XM2S-2513 or equivalent	25-pin type, inch screws, Manufactured by OMRON.
	XM2S-0911 or equivalent	9-pin type, mm screws, Manufactured by OMRON.
	XM2S-0911-E or equivalent	9-pin type, mm screws, Manufactured by OMRON.
	XM2S-0913 or equivalent	9-pin type, inch screws, Manufactured by OMRON.
	DB-C2-J9	25-pin type, Manufactured by JAE.

Cables for CS1-series PLC Peripheral Port

Model	Specifications
CS1W-CN118	Manufactured by OMRON (CS1-series peripheral port-to-D-Sub female 9-pin connector)

Appendix 9 List of Optional Products

A-9-1 Anti-reflection Sheets: NS15-KBA04, NS12-KBA04, NS7-KBA04, NT30-KBA04

Attached to the display to prevent random reflection and dirt. The sheets are all colorless and transparent. One set contains five sheets.

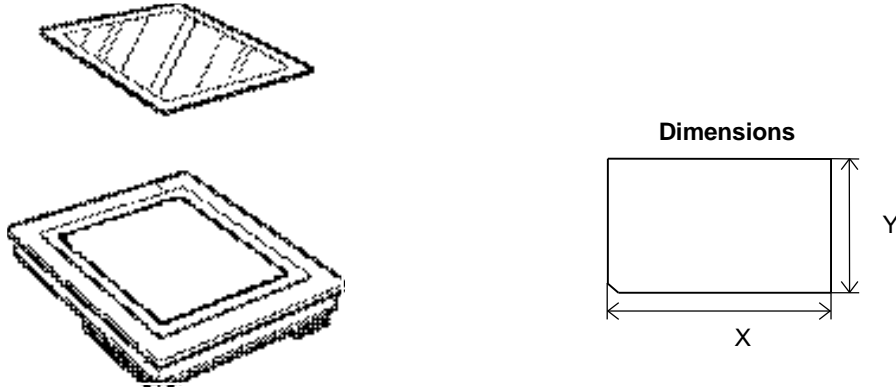

Model	Material	Mounting method
NS15-KBA04 NT30-KBA04	Polyester film	Double-sided tape
NS12-KBA04 NS7-KBA04	Polyester film	Coating of paste

Model	Specifications	Dimensions (Unit: mm)	
		X	Y
NS15-KBA04	Anti-reflection Sheets for NS15	323.5	247.5
NS12-KBA04	Anti-reflection Sheets for NS12/NS10	269.5	205.5
NS7-KBA04	Anti-reflection Sheets for NS8	188.6	147.2
NT30-KBA04	Anti-reflection Sheets for NS5	155.0	115.0

A-9-2 Protective Covers: NS15-KBA05N, NS12-KBA05(N), NS7-KBA05(N), NT31C-KBA05(N)

This cover protects the display surface from oil, dust, and finger marks. One set contains five covers.

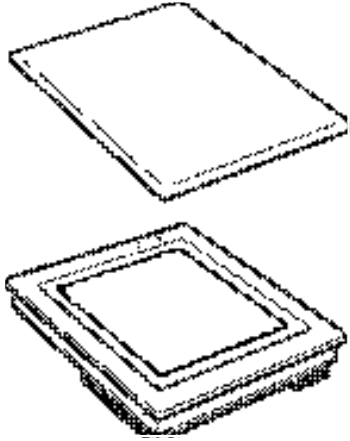

Dimensions

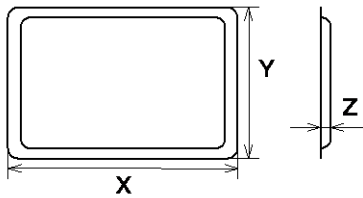

With Cover Mounted

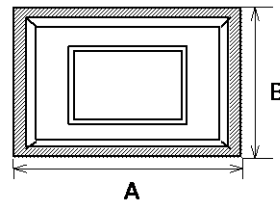

Note: Do not lift the product by grasping the shaded areas.

Material	Mounting method
Polyester film	Double-sided tape

Model	Specifications	Dimensions (Unit: mm)				
		X	Y	Z	A	B
NS12-KBA05	Opaque White Protective Cover for NS12 and NS10 (anti-reflection coating)	339	265	8.8	349	275
NS7-KBA05	Opaque White Protective Cover for NS8 (anti-reflection coating)	255	200	6.3	265	210
NT31C-KBA05	Opaque White Protective Cover for NS5 (anti-reflection coating)	218	165	7.0	228	175
NS15-KBA05N	Transparent Protective Cover for NS15	429	328	9.0	439	338
NS12-KBA05N	Transparent Protective Cover for NS12 and NS10	339	265	8.8	349	275
NS7-KBA05N	Transparent Protective Cover for NS8	255	200	6.3	265	210
NT31C-KBA05N	Transparent Protective Cover for NS5	213	160	6.5	223	170

A-9-3 NT30-KBA01 Chemical-resistant Cover

This Cover on the front panel protects the Unit from chemicals. The whole sheet is opaque white and made from silicon rubber.

Dimensions

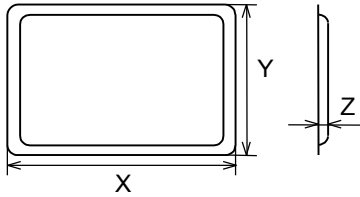

Model	Specifications	Dimensions (Unit: mm)		
		X	Y	Z
NT30-KBA01	Chemical-resistant Cover for the -V1/-V2	196.4	143.4	5.2

The Unit's resistance to chemicals is as shown below.

Resistant	Non-resistant
Boric acid	Hexane
Sulfuric acid	Lubricating oil
Nitrogen	Benzine
Ammonia gas	Butane
Carbon dioxide	Carbonic acid
Phenol	Chloric acid
Glycerin	Naphthaline
Aqua ammonia	Soybean oil
Calcium chloride	Toluene
Developing solution (Sodium thiosulfate)	
Acetaldehyde	
Lard	

Contact an OMRON representative for information on resistance to any chemicals not included in the table above. (The product can be used with chemicals to which silicon rubber is resistant, even if those chemicals are not included in the "Resistant" column in the table.)

A-9-4 Replacement Battery: CJ1W-BAT01

This is a lithium battery for backing up the contents of the memory.

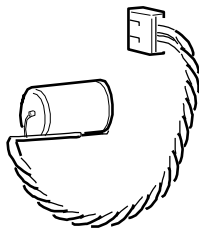

CJ1W-BAT01

Model	Specifications
CJ1W-BAT01	Replacement Battery for NS15-V2, NS12-V1/V2, NS10-V1/-V2, NS8-V1/-V2, NS5-V1/-V2

A-9-5 Recommended Memory Cards

The Memory Card is an external memory that can save and read screen data, log data, and system programs between the PT and computer. By using the HMC-AP001, this data can be exchanged with computers that are connected to PC Cards.

The memory capacity depends on the model of the Memory Card used.

Model	Capacity
HMC-EF183	128 Mbytes
HMC-EF283	256 Mbytes
HMC-EF583	512 Mbytes

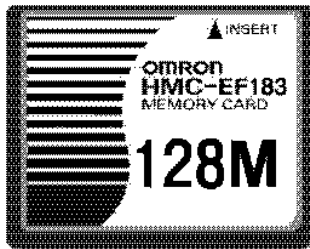

Note Use a Memory Card recommended by OMRON. Incorrect operation may occur if a non-recommended memory card is used.

A-9-6 NS-CLK21 Controller Link Interface Unit

This Expansion Unit enables Controller Link communications with PLCs and FA computers.

Applicable PTs: NS15-TX0□, NS12-TS0□ or NS10-TV0□

Inapplicable PTs: NS8-TV□□ or NS5-SQ□□/TQ□□/MQ□□

A-9-7 NS-CA001/CA002 Video Input Unit

This Expansion Unit enables displaying video images from video cameras or Vision Sensors on the PT.

An external analog RGB image can be input with the NS-CA002 and displayed on the PT. Refer to the *NS Series RGB/Video Input Unit Operation Manual* (Cat. No. V086) for details on the NS-CA002.

Applicable PTs: NS15-TX0□ (The NS15-TX0□ does not support the NS-CA001, and it does not support video input from the NS-CA002, but it supports analog RGB input from the NS-CA002.), NS12-TS0□, NS10-TV0□ or NS8-TV□□

Inapplicable PTs: NS5-SQ□□/TQ□□/MQ□□

A-9-8 Attachments: NS12-ATT01(B)/NS12-ATT02/NS8-ATT01/NS8-ATT02

NS-series PTs and NT-series PTs are different sizes and have different panel cutout dimensions. To replace an NT-series PT with an NS-series PT, install an attachment to the control panel in which the NT-series PT was mounted before mounting the NS-series PT.

Model	Specifications
NS12-ATT01	NT625C/631/631C Series to NS12/10 Series
NS12-ATT01B	NT625C/631/631C Series to NS12/10 Series (black)
NS12-ATT02	NT610C Series to NS12/10 Series
NS8-ATT01	NT620S/620C/600S Series to NS8 Series
NS8-ATT02	NT600M/600G/610G/612G Series to NS8 Series

A-9-9 NS-USBEXT-1M USB Relay Cable

A NS-USBEXT-1M USB Relay Cable can be used to extend the USB slave connector on the back of the PT and place it on the front of the control panel.

Model	Specifications
NS-USBEXT-1M	For NS15, NS12, NS10, NS8, NS5 V2 PTs

Appendix 10 System Memory List

System memory is used for exchanging information between the host and the PT, such as controlling the PT and notifying the host of PT status.

The system memory is divided into bit and word sections.

System Bit Memory (\$SB)

System bit memory (\$SB) is used for exchanging information between the host and the PT in bit units, such as controlling the PT and notifying the host of PT status.

The system bit memory contains 64 bits with predefined functions.

The system bit memory is listed in the following table.

Address	Classification	Function
\$SB0	Notification	RUN signal (Pulse)
\$SB1	Notification	RUN signal (Always ON)
\$SB2	Notification	Screen switch strobe
\$SB3	Control	Prohibit Shifting to System Menu
\$SB4	Notification	Battery Low
\$SB5	Notification	Data Input Detector
\$SB6	Control	Brightness adjust, high
\$SB7	Control	Brightness adjust, medium
\$SB8	Control	Brightness adjust, low
\$SB9	Control	Backlight Control (screen saver Control)
\$SB10	Control	Control Backlight Flashing
\$SB11	Notification	Backlight status
\$SB12	Control	Continuous buzzer
\$SB13	Control	Short intermittent buzzer
\$SB14	Control	Long intermittent buzzer
\$SB15	Notification/control	Notification/Control of Video Input
\$SB16	Control	Processing Priority Registration for Port A (NT Link 1:N)
\$SB17	Control	Processing Priority Registration Port B (NT Link 1:N)
\$SB18	Control	Display keypad with temporary input
\$SB19	Control	Prohibit input
\$SB20	Control	Contrast Adjustment (+10 levels) (NS5-SQ/MQ only)
\$SB21	Control	Contrast Adjustment (+1 level) (NS5-SQ/MQ only)
\$SB22	Control	Contrast Adjustment (-1 level) (NS5-SQ/MQ only)
\$SB23	Control	Contrast Adjustment (-10 levels) (NS5-SQ/MQ only)
\$SB24	Notification/control	Video Capture
\$SB25	Control	Starts Printing/Capture Screen (Not supported by NS5-□Q0□.)
\$SB26	Control	Stops Printing
\$SB27	Control	Test Pattern Printing
\$SB28	Control	Printer Head Cleaning (Ignored for PictBridge.)
\$SB29	Control	Update Printer Status
\$SB30	Notification	Printer Busy Status
\$SB31	Notification	Notification of Printer Error
\$SB32	Notification/control	Initialize Alarm/Event History
\$SB33	Notification/control	Save Alarm/Event History
\$SB34	Notification/control	Internal Holding Memory (\$HB/\$HW) Initialization
\$SB35	Notification/control	Initialize Data Log
\$SB36	Notification/control	Save Data Log
\$SB37	Notification/control	Initialize Operation Log
\$SB38	Notification/control	Save Operation Log
\$SB39	Control	Log Functional Object Operation

Address	Classification	Function
\$SB40	Control	Log Switch Screen Operation
\$SB41	Control	Log Macro Operation
\$SB42	Notification/control	Initialize Error Log
\$SB43	Notification/control	Save Error Log
\$SB44	–	Reserved
\$SB45	Control	Macro error dialog control
\$SB46	Notification	Notification of Macro Error
\$SB47	Notification	Logging Process or Video Capture Error Flag
\$SB48	Notification	Memory Card Free Space Check Flag
\$SB49	Notification/control	Stop Memory Card
\$SB50	Notification	Memory Card Removing Status (Power OFF)
\$SB51	Notification	Periodical Data Log Save in Process Flag
\$SB52	Notification	Data Block Operation Complete Flag
\$SB53	Notification/control	Prohibit Starting of the Screen Saver
\$SB54	Notification	Password level 1 operable status
\$SB55	Notification	Password level 2 operable status
\$SB56	Notification	Password level 3 operable status
\$SB57	Notification	Password level 4 operable status
\$SB58	Notification	Password level 5 operable status
\$SB59	–	Reserved
\$SB60	–	Reserved
\$SB61	–	Reserved
\$SB62	–	Reserved
\$SB63	–	Reserved

The notification words are not write prohibited. In addition, the system will not restore values, except when the status has changed.

System memory is allocated to PLC areas as shown below.

Allocated Addresses for System Memory can be displayed by selecting **PT – System Settings** in the CX-Designer and clicking the **Initial** Tab.

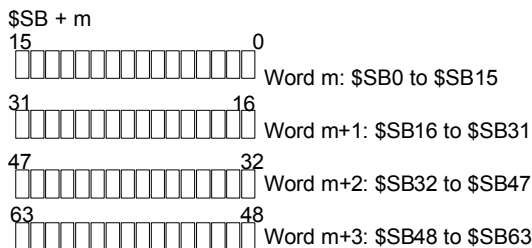

System Word Memory (\$SW)

System word memory (\$SW) is used for exchanging information between the host and the PT in word units, such as controlling the PT and notifying the host of PT status.

The system word memory contains 41 items with predefined functions.

The system word memory is listed in the following table.

Address	Classification	Function
\$SW0	Notification/control	Current screen number
\$SW1	Notification/control	Display pop-up screen 1 number
\$SW2	Notification/control	Pop-up screen 1 display position (X coordinate)
\$SW3	Notification/control	Pop-up screen 1 display position (Y coordinate)
\$SW4	Notification/control	Display pop-up screen 2 number
\$SW5	Notification/control	Pop-up screen 2 display position (X coordinate)
\$SW6	Notification/control	Pop-up screen 2 display position (Y coordinate)
\$SW7	Notification/control	Display pop-up screen 3 number

Address	Classification	Function
\$SW8	Notification/control	Pop-up screen 3 display position (X coordinate)
\$SW9	Notification/control	Pop-up screen 3 display position (Y coordinate)
\$SW10	Notification/control	Display label number
\$SW11	Control	Destination (0: Printer/1: Memory Card)
\$SW12	Control	Backlight Brightness Adjustment (1 to 32) (See note.)
\$SW13	Control	Password number for input prohibit clear
\$SW14	Notification	Current time (min, s)
\$SW15	Notification	Current date and time (day, hour)
\$SW16	Notification	Current date (year, month)
\$SW17	Notification	Current day (day of the week)
\$SW18	Notification	No. of generated alarms and events
\$SW19	Notification	ID number for generated alarms and events
\$SW20	Notification	ID number for cleared alarms and events
\$SW21	Notification	Alarm/event ID when alarm/event object macro executed
\$SW22	–	Reserved
\$SW23	Notification	Macro execution error number
\$SW24	Notification	Macro error screen number
\$SW25	Notification	Macro error object ID number
\$SW26	Notification	Error macro execution timing
\$SW27	Control	Offset value for index I0
\$SW28	Control	Offset value for index I1
\$SW29	Control	Offset value for index I2
\$SW30	Control	Offset value for index I3
\$SW31	Control	Offset value for index I4
\$SW32	Control	Offset value for index I5
\$SW33	Control	Offset value for index I6
\$SW34	Control	Offset value for index I7
\$SW35	Control	Offset value for index I8
\$SW36	Control	Offset value for index I9
\$SW37	Notification/control	Data Log Group Number
\$SW38	Notification	Data Block Error Number
\$SW39	Notification	Authentication level
\$SW40	Notification/control	Range of initialize Alarm/Event History

Note: This is supported only by NS5-SQ1/-TQ1 PTs with lot number 15Z0 or later, NS8 PTs with lot number 28X1 or later, NS10 PTs with lot number 11Y1 or later, NS12 PTs with lot number 14Z1 or later, and NS15 PTs with lot number 31114 or later.

The notification words are not write prohibited. In addition, the system will not restore values, except when the status has changed.

System word memory is allocated to PLC memory as shown below.

Allocated Addresses for System Memory can be displayed by selecting **PT – System Settings** in the CX-Designer and clicking the **Initial** Tab.

\$SW = n

Word n: \$SW0

Word n+1: \$SW1

Word n+40: SW40

Reference • System memory can be allocated to PLC memory using the same procedure as for NT-series PTs. For details, refer to 2-4-3 *System Memory NT Compatibility* in the *NS Series Programming Manual*.

Appendix 11 Differences between "-V1"/"-V2" Models and Other Models

In the NS Series, there are hardware items both with and without "-V1" and "-V2" at the end of the model number.

	Model	Notes
Hardware items without "-V1"	NS12-TS00	12.1 inches, no Ethernet connection
	NS12-TS01	12.1 inches, Ethernet connection
	NS10-TV00	10.4 inches, no Ethernet connection
	NS10-TV-01	10.4 inches, Ethernet connection
	NS7-SV00	7.7 inches, no Ethernet connection
	NS7-SV01	7.7 inches, Ethernet connection
Hardware items with "-V1"	NS12-TS00-V1	12.1 inches, no Ethernet connection
	NS12-TS01-V1	12.1 inches, Ethernet connection
	NS10-TV00-V1	10.4 inches, no Ethernet connection
	NS10-TV01-V1	10.4 inches, Ethernet connection
	NS8-TV□0-V1	8.0 inches, no Ethernet connection
	NS8-TV□1-V1	8.0 inches, Ethernet connection
	NS5-SQ00-V1	5.7 inches, no Ethernet connection
	NS5-SQ01-V1	5.7 inches, Ethernet connection
Hardware items with "-V2"	NS12-TS00-V2	12.1 inches, no Ethernet connection
	NS12-TS01-V2	12.1 inches, Ethernet connection
	NS10-TV00-V2	10.4 inches, no Ethernet connection
	NS10-TV01-V2	10.4 inches, Ethernet connection
	NS8-TV00-V2	8.4 inches, no Ethernet connection
	NS8-TV01-V2	8.4 inches, Ethernet connection
	NS5-SQ00-V2	5.7 inches, no Ethernet connection
	NS5-SQ01-V2	5.7 inches, Ethernet connection
	NS5-SQ10-V2	5.7 inches, no Ethernet connection
	NS5-SQ11-V2	5.7 inches, Ethernet connection
	NS5-TQ00-V2	5.7 inches, no Ethernet connection
	NS5-TQ01-V2	5.7 inches, Ethernet connection
	NS5-TQ10-V2	5.7 inches, no Ethernet connection
	NS5-TQ11-V2	5.7 inches, Ethernet connection
	NS5-MQ00-V2	5.7 inches, no Ethernet connection
	NS5-MQ01-V2	5.7 inches, Ethernet connection
	NS5-MQ10-V2	5.7 inches, no Ethernet connection
	NS5-MQ11-V2	5.7 inches, Ethernet connection

The differences between "-V1" and "-V2" models and other models are shown below. For details on the differences in software functions, refer to the *Programming Manual*.

	Without "-V1" or "-V2"			With "-V1"			
	NS12-TS0□	NS10-TV0□	NS7-SV0□	NS12-TS0□-V1	NS10-TV0□-V1	NS8-TV□□-V1	NS5-SQ0□-V1
Display device	High-definition TFT color LCD		STN color LCD	High-definition TFT color LCD			STN color LCD
Display color	256 colors			256 colors (32,768 colors for BMP/JPEG images, NS5: 4,096 colors for BMP/JPEG images)			
Display area	12.1 inches	10.4 inches	7.7 inches	12.1 inches	10.4 inches	8.0 inches	5.7 inches
View angle	Left/right ±60°, Top 45°, Bottom 55°	Left/right, ±60°, Top 35°, Bottom 65°	Left/right ±60°, Top 35°, Bottom 65°	Left/right ±60°, Top 45°, Bottom 55°	Left/right ±60°, Top 35°, Bottom 65°	Left/right ±60°, Top 50°, Bottom 60°	Left/right ±50°, Top 30°, Bottom 50°
Expansion memory interface	With		Without	Without			
USB HOST	Without			With			Without
USB Slave	Without			With			
Ethernet conformance standard	10Base-T (Ethernet models only)			10Base-T/100Base-T (Ethernet models only)			
Replacement Battery	C500-BAT08		CPM2A-BAT01	CJ1W-BAT01			

	With "-V2"						
	NS12-TS0□-V2	NS10-TV0□-V2	NS8-TV□□-V2	NS5-SQ□□-V2 (See note 1.)	NS5-TQ□□-V2	NS5-MQ□□-V2	
Display device	High-definition TFT color LCD			TFT color LCD	High-definition TFT color LCD (See note 2.)	Monochrome STN LCD	
Display color	256 colors (32,768 colors for BMP/JPEG images)			256 colors (32,768 colors for BMP/JPEG images)	Monochrome/16 grayscale levels		
Display area	12.1 inches	10.4 inches	8.4 inches	5.7 inches			
View angle	Left/right ±80°, Top 80°, Bottom 80°	Left/right ±70°, Top 65°, Bottom 65°	Left/right ±80°, Top 80°, Bottom 60°	Left/right ±80°, Top 80°, Bottom 60°		Left/right ±45°, Top 20°, Bottom 40°	
Expansion memory interface	Without						
USB HOST	With			Without			
USB Slave	With						
Ethernet conformance standard	10Base-T/100Base-T (Ethernet models only)						
Replacement Battery	CJ1W-BAT01						

Note 1. Specifications are as follows for NS5-SQ□□-V2 PTs with lot number 2110 (manufactured January 21, 2010) or earlier.

Item	Specification
Display device	STN color LCD
Display colors	256 colors (4,096 colors for BMP/JPEG images)
View angle	Left 50°, Top 45°, Bottom 50°

Refer to *NS-series PT Lot Numbers* on page A-8 for information on lot numbers.

2. The NS5-TQ PTs (high-luminance TFT LCDs) are approx. 70 cd/m² brighter than the NS5-SQ PTs (TFT LCDs).

Appendix 12 NS5 System Menu

This section describes the NS5 System Menu screen. Some items are slightly different for the NS8, NS10, NS12, and NS15. Check all items in the table below before setting or monitoring.



No.	Menu	Item/settings	Setting/display	Reference	
(1)	Initialize	Memory Card (remove)	Setting/display	6-2-7	
		Initializing Internal Holding Memories (\$HB/\$HW)	Setting	6-2-8	
		Screen Data Area Format	Setting	6-2-1	
		History File Initialize or Save			
		Alarm/Event History	Setting	6-2-2	
		Data Log	Setting	6-2-3	
		Operation Log	Setting	6-2-4	
		Error Log	Setting	6-2-5	
(2)	PT Settings	Start-up Waiting Time	Setting	6-3-1	
		Screen Saver	Setting	6-3-2	
		Key Press Sound	Setting	6-3-3	
		Buzzer Sound	Setting	6-3-4	
		Backlight	Setting	6-3-5	
		Contrast	Setting	6-3-11	
		Calendar Check	Setting	6-3-6	
		Changing Value in Device Monitor Setting	Setting	6-3-10	
		CJK Han Unification Priority	Setting	6-3-12	
		Alarm Monitor Registration Procedure	Setting	6-3-13	
		Tag Update Notification Message Setting	Setting	6-3-15	

No.	Menu	Item/settings	Setting/ display	Reference	
(3)	Project	Project Title	Display	6-4-1	
		Number of Labels	Display	6-4-2	
		Initial Screen	Setting	6-4-3	
		Initial Label	Setting	6-4-4	
		Barcode input when using keypad	Setting	6-4-5	
		History Recording Method			
			Alarm/Event History	Display	6-4-6
			Data Log	Display	6-4-7
			Operation Log	Display	6-4-8
			Error Log	Display	6-4-9
	Addresses Allocated to System Memory (\$SB,\$SW)	Display	6-4-10		
(4)	Password	Password Change	Setting	6-5	
		Password mode			
			Level	Setting	6-5-2
			Time Out	Setting	6-5-2
			Timeout (min)	Setting	6-5-2
			Switch Screen when canceling authentication	Setting	6-5-2
			Switch Screen No.	Setting	6-5-2
(5)	Comm.	Automatic Communications Recovery (Comms. Auto-return)	Setting	6-6-1	
		Timeout Interval	Setting	6-6-1	
		Retry Count	Setting	6-6-1	
		Serial Port A or B Communications Settings	Setting	6-6-1	
		Ethernet Communications Settings	Setting	6-6-4	
(6)	Data Check	Screen Number	Setting	6-7	
		Show Address	Setting	6-7	

No.	Menu	Item/settings	Setting/ display	Reference	
(7)	Special Screen	Error Occurrence/Frequency for All History Files			
		Alarm History	Display	6-8-1	
		Operations Log	Display	6-8-2	
		Error Log	Display	6-8-3	
		System Version		Display	6-8-11
		Special Functions			
		Device Monitor	Setting/ display	6-8-4	
		Communication Test	Setting	6-8-5	
		Display Capture Data	Display	6-8-8	
		Memory Card Transfer	Setting	6-8-9	
External Application Start-up	Setting	6-8-10			
(8)	Hardware Check	LCD Check		Display	6-9-1
		Touch Switch Check		Display	6-9-2
(9)	Language Se- lection	Language Selection		Display	6-2-6

Revision History

A manual revision code appears as a suffix to the catalog number on the cover of the manual.

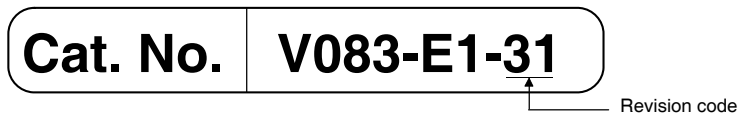

The following table outlines the changes made to the manual during each revision. Page numbers refer to the previous version.

Revision code	Date	Revised content
01	April 2003	Original production
02	October 2003	Added a new section on starting external applications. Added information throughout the manual to include the NS5-V1.
03	July 2004	Changes and corrections for version upgrade.
04	February 2005	Changes and corrections related to the addition of the NS5-V2 Series.
05	October 2005	Changes and corrections related to the addition of the NS12-V2, NS10-V2, and NS8-V2 Series.
06	July 2006	Changes related to release of the CX-Designer.
07	July 2007	Changes and corrections for version upgrade.
08	March 2008	Added new <i>Application Precautions</i> and changed their order. Added <i>Conformance to EC Directives</i> information to sections 2 and 3. Changed enclosure rating information in <i>Appendix 1</i> .
09	June 2008	Changes related to upgrade and addition of NS5-SQ1□-V2, NS5-TQ1□-V2, and NS5-MQ1□-V2.
10	October 2008	Changes related to version upgrade.
11	November 2008	Changes and corrections
12	April 2009	Changes related to version upgrade.
13	August 2009	Changes and corrections
14	December 2009	Additions related to Windows 7.
15	February 2010	Revisions accompanying changes in display device specifications.
16	March 2010	Added information on grounding.
17	October 2010	Changes related to version upgrade.
18	November 2010	Revisions accompanying changes to the backlight in the NS5-SQ1/-TQ1.
19	July 2011	Changes for support for NJ-series Controllers.
20	October 2011	Revision accompanying changes to the backlight in the NS8/NS10/NS12.
21	January 2012	Changes related to version upgrade.
22	April 2012	Changes related to version upgrade.
23	April 2012	Changes related to changes in lot numbers.
24	September 2013	Additions related to Windows 8.
25	December 2013	Revisions accompanying changes to the backlight in the NS15.
26	April 2015	Revision for support NX Series.
27	October 2016	Revisions accompanying support for NX1P2-series Controllers.
28	October 2016	Changed accessories. Corrected mistakes.
29	December 2017	Deleted the expansion I/F connector. Corrected mistakes.
30	October 2018	Revisions accompanying support for NX1 Controller.
31	June 2020	Revisions accompanying support for CP2E-Series Controllers.

OMRON AUTOMATION AMERICAS HEADQUARTERS • Chicago, IL USA • 847.843.7900 • 800.556.6766 • automation.omron.com

OMRON CANADA, INC. • HEAD OFFICE

Toronto, ON, Canada • 416.286.6465 • 866.986.6766 • automation.omron.com

OMRON ELECTRONICS DE MEXICO • HEAD OFFICE

Ciudad de México • 52.55.5901.4300 • 01.800.386.6766 • mela@omron.com

OMRON ELECTRONICS DE MEXICO • SALES OFFICE

San Pedro Garza García, N.L. • 81.12.53.7392 • 01.800.386.6766 • mela@omron.com

OMRON ELECTRONICS DE MEXICO • SALES OFFICE

Eugenio Garza Sada, León, Gto • 01.800.386.6766 • mela@omron.com

OMRON ELETRÔNICA DO BRASIL LTDA • HEAD OFFICE

São Paulo, SP, Brasil • 55 11 5171-8920 • automation.omron.com

OMRON ARGENTINA • SALES OFFICE

Buenos Aires, Argentina • +54.11.4521.8630 • +54.11.4523.8483
mela@omron.com

OTHER OMRON LATIN AMERICA SALES

+54.11.4521.8630 • +54.11.4523.8483 • mela@omron.com

Authorized Distributor:

Controllers & I/O

- Machine Automation Controllers (MAC) • Motion Controllers
- Programmable Logic Controllers (PLC) • Temperature Controllers • Remote I/O

Robotics

- Industrial Robots • Mobile Robots

Operator Interfaces

- Human Machine Interface (HMI)

Motion & Drives

- Machine Automation Controllers (MAC) • Motion Controllers • Servo Systems
- Frequency Inverters

Vision, Measurement & Identification

- Vision Sensors & Systems • Measurement Sensors • Auto Identification Systems

Sensing

- Photoelectric Sensors • Fiber-Optic Sensors • Proximity Sensors
- Rotary Encoders • Ultrasonic Sensors

Safety

- Safety Light Curtains • Safety Laser Scanners • Programmable Safety Systems
- Safety Mats and Edges • Safety Door Switches • Emergency Stop Devices
- Safety Switches & Operator Controls • Safety Monitoring/Force-guided Relays

Control Components

- Power Supplies • Timers • Counters • Programmable Relays
- Digital Panel Meters • Monitoring Products

Switches & Relays

- Limit Switches • Pushbutton Switches • Electromechanical Relays
- Solid State Relays

Software

- Programming & Configuration • Runtime